

# OMRON

## Safety Mat / Safety Mat Controller

UM/MC3



Stay one step ahead in safety



realizing

# Safety Mats are safety measures that take into consideration usability in the workplace.

OMRON Safety Mats continue on their unique path of evolution. On-site safety can be further improved by placing Safety Mats precisely in areas where other sensors do not reach. The Safety Mats elicit the full power of every location and are suitable for any application.

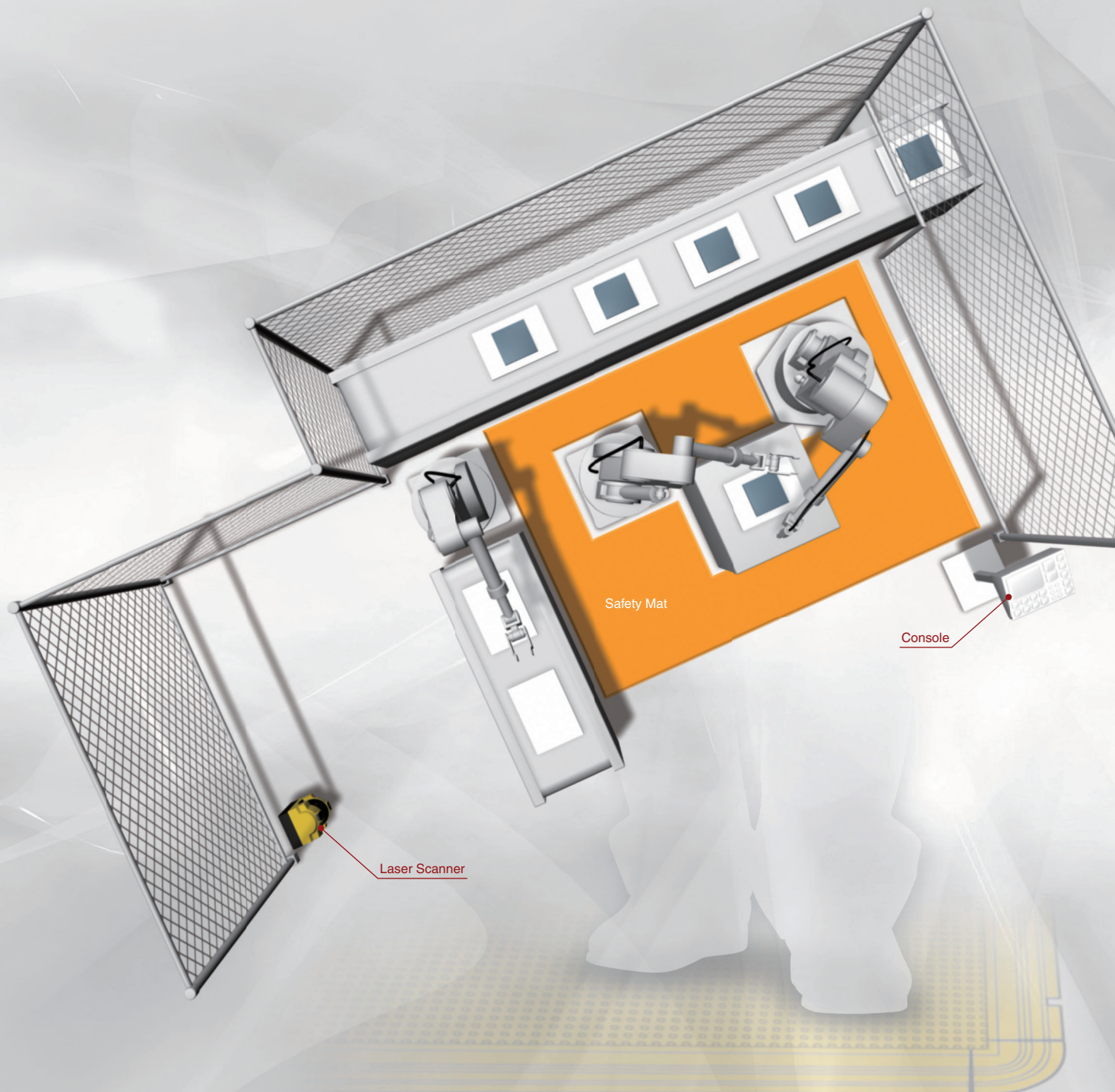

## Complies with international safety standards

The safety mat has received EN ISO 13856-1 safety standard certification and complies with ANSI/RIA15.06 and other standards. Meets PLd/ Safety Category 3 (EN ISO13849-1) requirements when used in combination with the safety controller G9SP or the safety mat controller MC3.



# Safety Mat UM Series

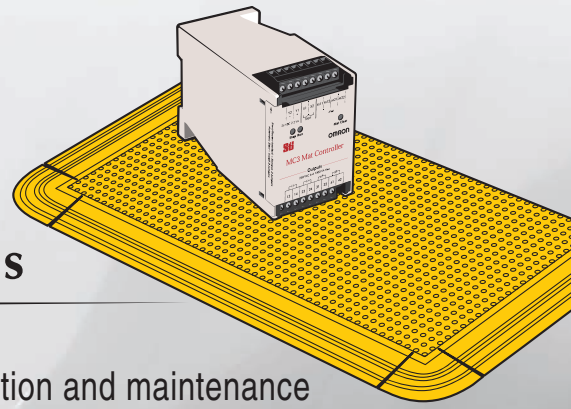

Reduce labor associated with cumbersome layout, installation and maintenance

## The UM system takes the site into consideration

### 1 Connectors make wiring simple

Cables with connectors make wiring easy, even when multiple mats are used.

#### Wiring for two Safety Mats

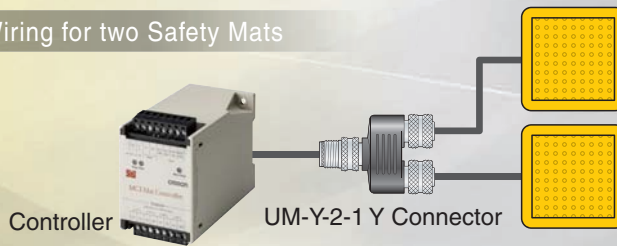

#### Wiring for six Safety Mats

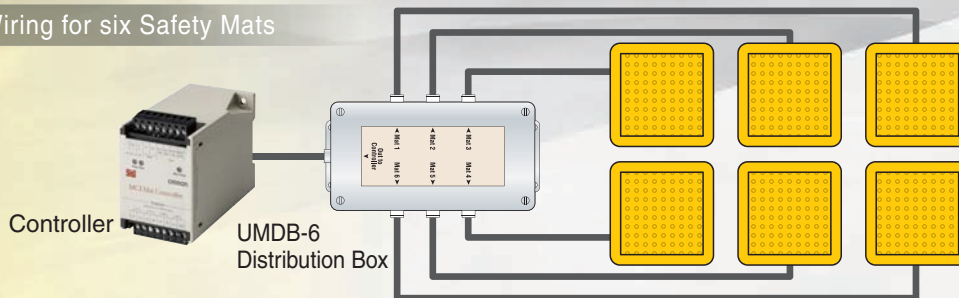

### 2 Trim that takes wiring and maintenance into consideration

The snap-type trim ensures proper cable installation and simplifies the maintenance and installation of mats.

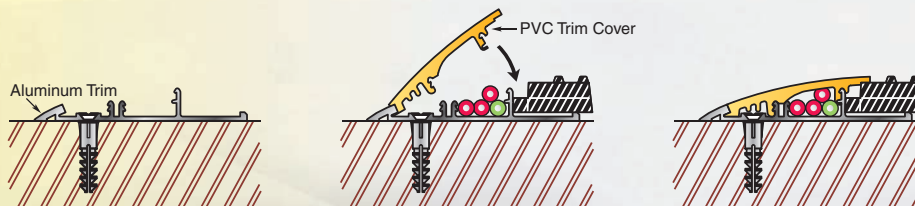

## Broad product selection ensures compatibility with a wide variety of sites

A variety of mat sizes are available. You can select mats that suit the protected area.

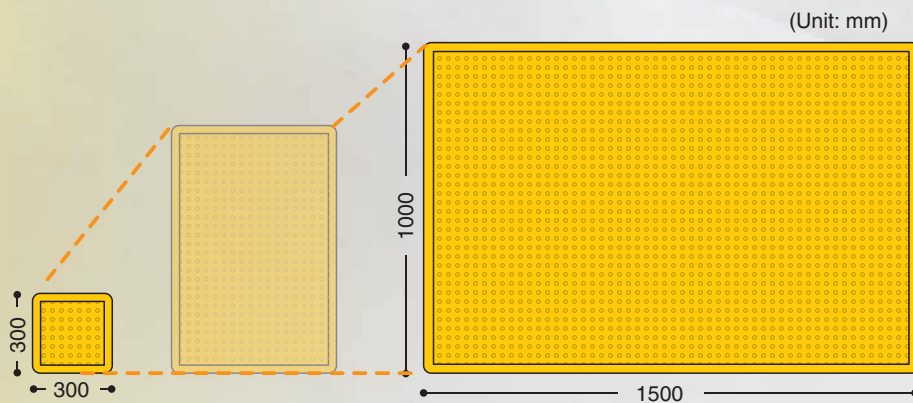

\* Mats sized in inches are also available for use in North America. Contact your dealer for more information about the models and delivery periods.

# Safety Mat/Safety Mat Controller

# UM/MC3

## Safety Mat That Is Easy to Install and Maintain

- Simple connection allows multiple mats to be joined together.
- A wide variety of mat sizes are available.
- Meets PLd/Safety Category 3 (EN ISO13849-1) requirements when used in combination with the safety controller G9SP or the safety mat controller MC3.
- Complies with North American safety standards, including ANSI/RIA15.06.

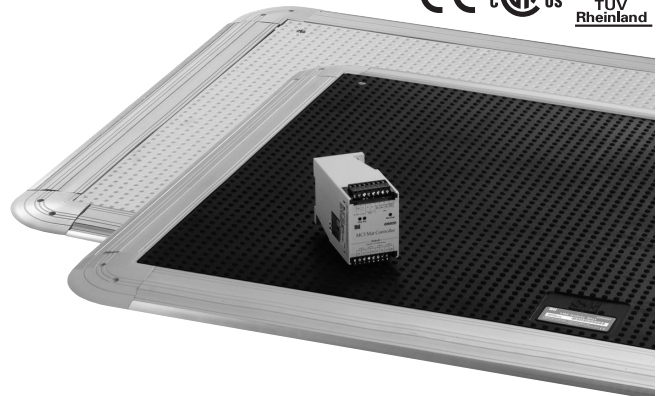

 Be sure to read the "Safety Precautions" on page 14 and 15.

## Model Number Structure

### Model Number Legend

#### Safety Mat

UM□□□-□□□  
 1 2 3 4 5

- |                 |                          |                        |                                  |
|-----------------|--------------------------|------------------------|----------------------------------|
| <b>1. Color</b> | <b>2. Unit of Length</b> | <b>3. Cable Length</b> | <b>4. Safety Mat Dimension A</b> |
| None : Black    | None : Inch              | 5 : 5 m                |                                  |
| Y : Yellow      | M : Millimeter           | 10 : 10 m              | <b>5. Safety Mat Dimension B</b> |

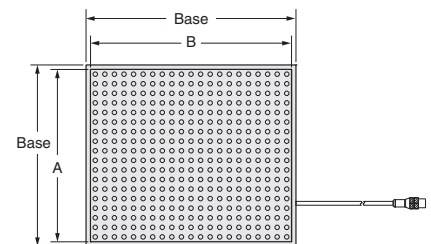

## Ordering Information

### Safety Mat Controller

Safety outputs	Auxiliary outputs	Rated voltage	Terminal block type	Model
SPDT-NO	SPDT-NC	24 VDC	Screw terminals	MC3

### Safety Mat

Dimensions		Black	Yellow
A (mm)	B (mm)	Model	Model
300	300	UMM5-0300-0300	UMYM5-0300-0300
400	400	UMM5-0400-0400	UMYM5-0400-0400
500	250	UMM5-0500-0250	UMYM5-0500-0250
500	400	UMM5-0500-0400	UMYM5-0500-0400
500	500	UMM5-0500-0500	UMYM5-0500-0500
500	1500	UMM5-0500-1500	UMYM5-0500-1500
600	400	UMM5-0600-0400	UMYM5-0600-0400
750	250	UMM5-0750-0250	UMYM5-0750-0250
750	500	UMM5-0750-0500	UMYM5-0750-0500
750	750	UMM5-0750-0750	UMYM5-0750-0750
750	1500	UMM5-0750-1500	UMYM5-0750-1500
1000	500	UMM5-1000-0500	UMYM5-1000-0500
1000	750	UMM5-1000-0750	UMYM5-1000-0750
1000	1000	UMM5-1000-1000	UMYM5-1000-1000
1000	1250	UMM5-1000-1250	UMYM5-1000-1250
1000	1500	UMM5-1000-1500	UMYM5-1000-1500

**Note:** 1. These Mats are made of rubber, and there is a tolerance of ±6 mm for the dimensions that are given above.  
 2. Refer to *Safety Mat in Dimensions* on page 10 for the dimensions of the base and the location of the cable.

**Trims**

Appearance	Name	Model	Remarks
	Ramp Trim with Yellow PVC Cover (1.22 m)	<b>UMRT4</b>	Installed on the perimeter of the Safety Mat. Each Trim is composed of two parts, an aluminum base and a PVC Cover. Possible to install cables inside.
	Ramp Trim with Yellow PVC Cover (2.44 m)	<b>UMRT8</b>	
	Joining Trim (1.22 m)	<b>UMJS4</b>	The Joining Trims join the Safety Mats when two or more Safety Mats are being combined. In addition to joining the Safety Mats, the Joining Trims preserve the Safety Mat's sensitivity at the joints.
	Joining Trim (2.44 m)	<b>UMJS8</b>	
	Aluminum Ramp Trim (2.44 m)	<b>UMAL</b>	Installed on the perimeter of the Safety Mat.
	Molded Outside Corner	<b>UMOC</b>	Installed at the outside corners of the Safety Mat combining with Ramp Trims with Yellow PVC Cover.
	Molded Inside Corner	<b>UMIC</b>	Installed at the inside corners when two or more Safety Mats combining with Ramp Trims with Yellow PVC Cover are being combined.

**Note:** 12 screws (No. 8-32 × 1.25") and 12 anchors are included with Ramp Trim with Yellow PVC Cover (UMRT4 and UMRT8) and Aluminum Ramp Trim (UMAL).

**Accessories**

Appearance	Name	Model	Remarks
	Distribution Box (for six mats)	<b>UMDB-6</b>	Used to connect to two or more Safety Mats to the single MC3 Safety Mat Controller.
	Waterproof Cover	<b>XS2Z-22</b>	Used to protect the unused connectors of UMDB-6.
	Y Connector	<b>UM-Y-2-1</b>	Used to connect two Safety Mats to the single MC3 Safety Mat Controller.
	Panel-mount Connector	<b>UMPMC</b>	Distributes to individual lines to connect the Safety Mat to a MC3 Safety Mat Controller.
	Extension Cable (3 m)	<b>UMEC-03</b>	This cable is used to extend a cable, or to connect the UMPMC to the UMDB-6.
	Extension Cable (5 m)	<b>UMEC-05</b>	
	Extension Cable (10 m)	<b>UMEC-10</b>	
	Extension Cable (15 m)	<b>UMEC-15</b>	
	Connector with cable Socket on one cable end (1 m)	<b>XS2F-D421-C80-F</b>	Used to connect the UMDB-6 to the MC3 Safety Mat Controllers.
	Connector with cable Socket on one cable end (2 m)	<b>XS2F-D421-D80-F</b>	
	Connector with cable Socket on one cable end (5 m)	<b>XS2F-D421-G80-F</b>	
	Connector with cable Socket on one cable end (10 m)	<b>XS2F-D421-J80-F</b>	

**Note:** For trims and accessories required for the Safety Mat system configuration, see "Installation" on page 7.

# UM/MC3

## Specifications

### Ratings

#### Safety Mat Controller

##### Power input

Item	Model	MC3
Power voltage		24 VDC
Operating voltage range		-15% to +15% of rated supply voltage
Power consumption *		3 W max.

\* Power consumption of loads is not included.

##### Switch

Item	Model	MC3
Rated load		6 A at 230 VAC/6 A at 24 VDC (resistive load) 5 A at 230 VAC (AC15)/2 A at 24 VDC (DC13) (inductive load)
Maximum rated voltage		250 VAC/24 VDC
Rated carry current		6 A
Maximum switching capacity		1,500 VA

### Characteristics

#### Safety Mat

Item	Model	UM
Detection method		Pressure sensing method
Actuating force		300 N min.
Maximum allowable load		2,000 N (EN ISO 13856-1 requirement)
Mechanical durability		1 million cycles min.
Material		PVC (Polyvinyl Chloride)
Ambient operating temperature		-37 to 66°C (with no icing or condensation)
Degree of protection		IP67
Weight		Approx. 24.4 kg/m <sup>2</sup>

#### Safety Mat Controller

Item	Model	MC3
Response time		30 ms max.
Safety input		Four-wire Safety Mat only Mat can be connected in series (Connectable number: 12 max.) The external impedance must be 8 Ω or less between M11 and M21 and between M12 and M22.
Safety output		SPDT-NO
Auxiliary output		SPDT-NC
Insulation resistance		20 MΩ min. (at 500 VDC)
Dielectric strength	Between different poles of outputs	1,800 VAC, 50/60 Hz for 1 sec.
	Between power supply and output	
Vibration resistance		Malfunction: 10 to 55 Hz, 0.15 mm single amplitude
Mechanical shock resistance		Malfunction: 98 m/s <sup>2</sup>
Durability	Mechanical	10,000,000 cycles min.
	Electrical	100,000 cycles min. (rated load, switching frequency: 360 cycles/hour)
Ambient operating temperature		0 to 55°C (with no icing or condensation)
Ambient operating humidity		0% to 90% RH
Degree of protection		IP20
Terminal tightening torque		0.5 N·m
Weight		Approx. 360 g

## Installation

### Using Trim Pieces

#### Ramp Trim with Yellow PVC Cover: UMRT4/UMRT8

Secures the edges of the Safety Mats to the floor.  
It is composed of two parts with an aluminum base and a PVC Cover.

#### Joining Trim: UMJS4/UMJS8

The Joining Trims join the Safety Mats when two or more Safety Mats are being combined.  
In addition to joining the Safety Mats, the Joining Trims preserve the Safety Mat's sensitivity at the joints.

#### Aluminum Ramp Trim: UMAL

Secures the edges of the Safety Mat to the floor.  
The Aluminum Ramp Trim is hollow, so cable can be routed through it.

#### Molded Outside Corner: UMOC

Used together with the Ramp Trim with Yellow PVC Cover (UMRT4/UMRT8) to secure the external corners of the Safety Mats to the floor.

#### Molded Inside Corner: UMIC

Used together with the Ramp Trim with Yellow PVC Cover (UMRT4/UMRT8) to secure the internal corners of the Safety Mats to the floor.

**Note: 1.** The Aluminum Ramp Trim or Ramp Trim with Yellow PVC Cover must be cut to fit the size of the Safety Mats being used.

Furthermore, when the Safety Mat's wiring is being routed through the Aluminum Ramp Trim or Ramp Trim with Yellow PVC Cover, it will be necessary to cut or notch the Aluminum Ramp Trim or Ramp Trim with Yellow PVC Cover for cable access.

Refer to the Safety Mat Instruction Sheet for details on cutting or notching the Aluminum Ramp Trim or Ramp Trim with Yellow PVC Cover.

- The Joining Trim must be cut to fit the size of the Safety Mats being used.
- The Ramp Trim with Yellow PVC Cover and Molded Corner must be anchored to the floor to secure the Safety Mats. It is also necessary to drill holes in the Trim to anchor it. Refer to the Safety Mat Instruction Sheet for details on drilling holes in the Trim and Molded Corner and anchoring it to the floor.

### Safety Mat Configuration

The Safety Mats are secured by anchoring the Ramp Trim with Yellow PVC Cover and Molded Corner to the floor.

Before ordering, confirm the number of Ramp Trim with Yellow PVC Cover and Molded Corner pieces that will be needed.

#### Example 1: Using a Single Safety Mat

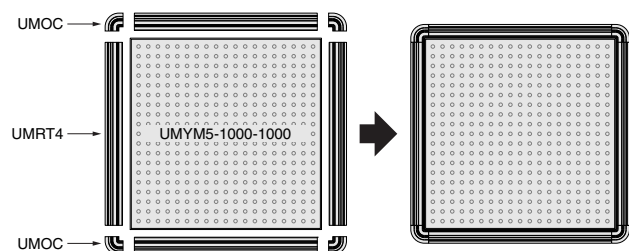

In this case, the perimeter of the Safety Mat is about 4 m and the following pieces are required:

- The example above consists of the following components:
- UMYM5-1000-1000 Safety Mat : 1 piece
  - UMRT4 Ramp Trim with Yellow PVC Cover (1.22 m) : 4 pieces
  - UMOC Molded Outside Corner : 4 pieces

#### Example 2: Using three Safety Mats

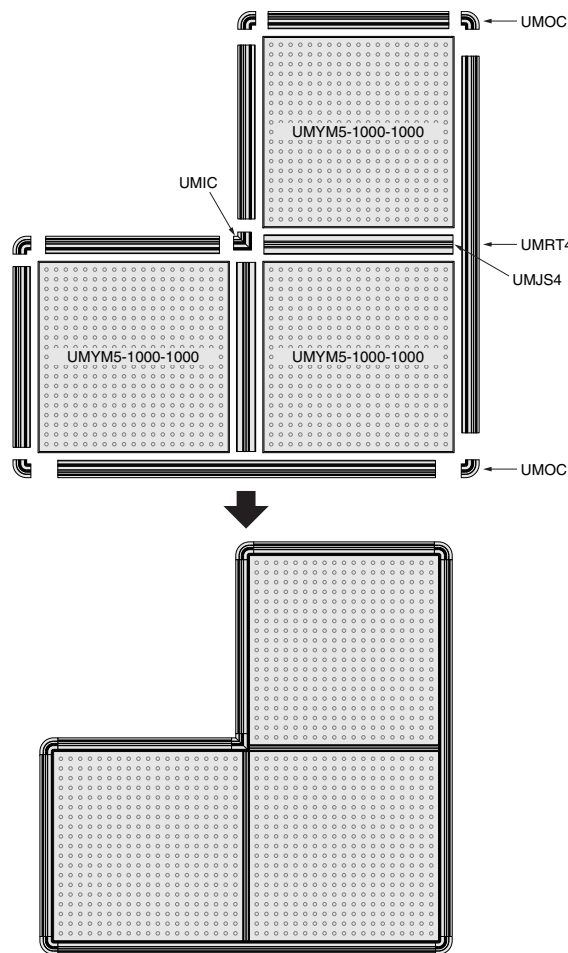

In this case, the perimeter of the Safety Mat is about 8 m, the joint between the Safety Mats is 2-m long, and the following pieces are required:

The example above consists of the following components:

- UMYM5-1000-1000 Safety Mat : 3 pieces
- UMRT4 Ramp Trim with Yellow PVC Cover (1.22 m) : 8 pieces
- UMJS4 Joining Trim (1.22 m) : 2 pieces
- UMOC Molded Outside Corner : 5 pieces
- UMIC Molded Inside Corner : 1 piece

## Wiring of Safety Mat and Safety Mat Controller

### Example 1: Using a Single Safety Mat

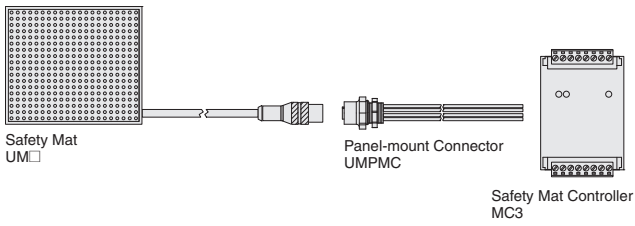

**Note:** You can cut a Safety Mat's cable and wire it to the MC3 Safety Mat Controller without using UMPMC.

### Example 2: Using Two Safety Mats

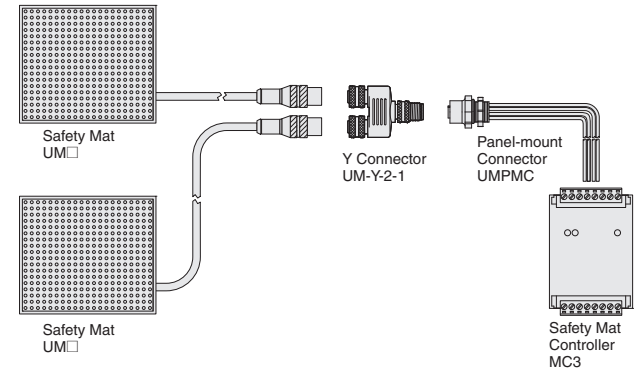

### Example 3: Using Six Safety Mats

Connecting directly to Safety Mat Controller

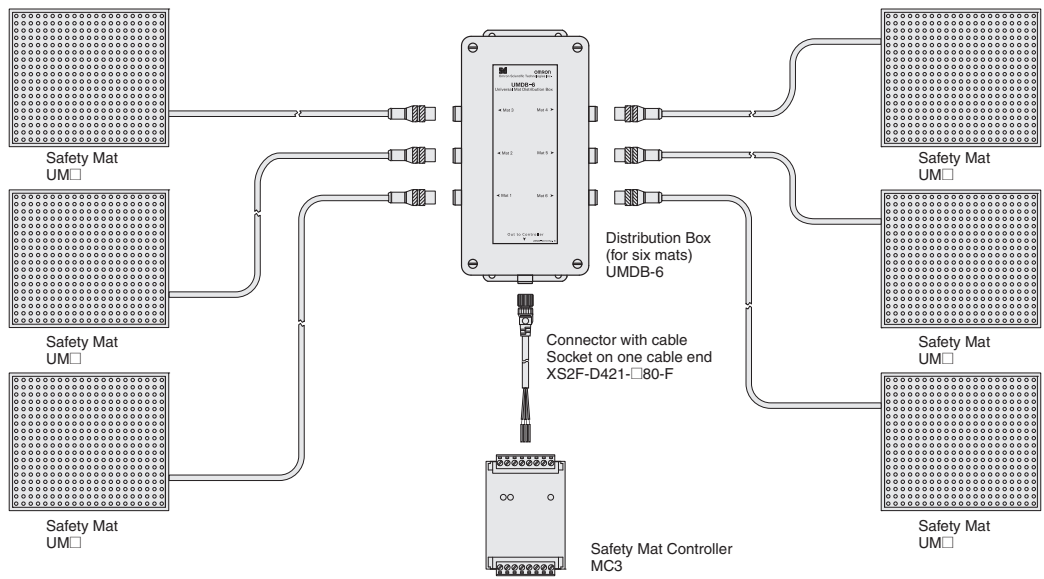

Connecting to Safety Mat Controller in a panel

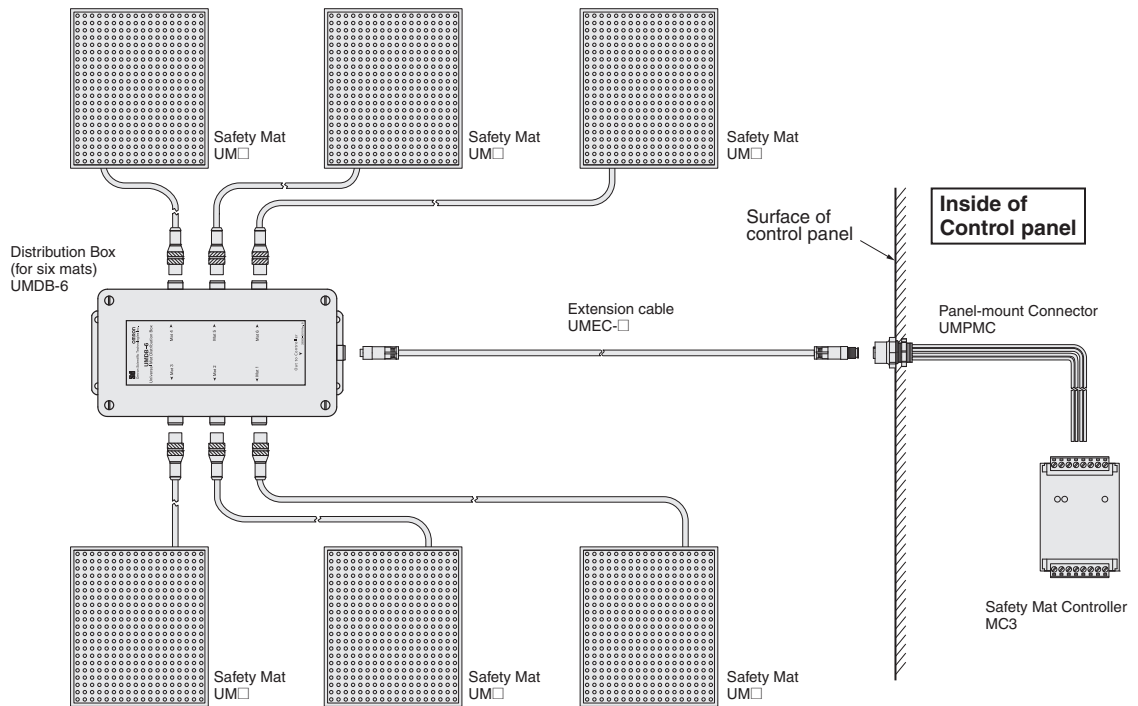

**Note:** 1. Use UMEC-□ Extension Cables as required by the distance between the Safety Mats and the Mat Controller.  
2. When using the UMDB-6 to connect to 1 to 5 Mats, change the wiring inside the UMDB-6. Refer to user documentation provided with the UMDB-6.

Contact your dealer for other wiring combinations.



## Connections

### Internal Connection

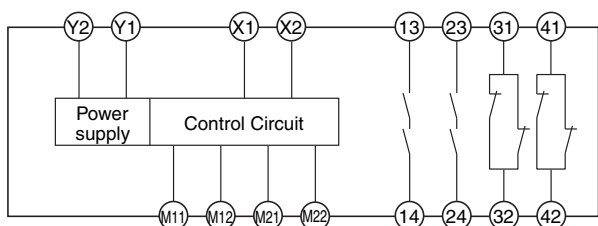

### Wiring of Inputs and Outputs

Signal name	Terminal name	Description of operation	Wiring
Power supply input	Y1, Y2	Power supply input terminals for MC3 Connect the power source to the Y1 and Y2 terminals.	Connect the power supply plus (24 VDC) to the Y1 terminal. Connect the power supply minus (GND) to the Y2 terminal.
Safety Mat input	M11, M12, M21, M22	To turn ON safety outputs, all the connected safety mats must have no load. Otherwise, the safety outputs will NOT turn ON.	
Reset input	X1, X2	The Safety Outputs can be turned ON only after the connection between X1 and X2 closes and then opens. If the connection between X1 and X2 does not close and open, the Safety Outputs will not turn ON.	<b>Manual Reset Mode</b>
		The normal operation can be made if the connection between X1 and X2 is open.	<b>Auto Reset Mode</b>
Safety output	13-14, 23-24	The Safety Outputs are turned ON and OFF according to the status of the Safety Mat inputs and the reset input.	Keep these outputs Open when NOT used.
Auxiliary output	31-32, 41-42	Turns ON/OFF according to the state of the opposite logic to the safety outputs.	Keep these outputs Open when NOT used.

### Changing the Reset Mode

You can select either the Auto Reset Mode or the Manual Reset Mode with the MC3 Controller.

Remove the terminal block from the top of the MC3 Controller to expose three yellow jumpers. Set the jumps as required by system specifications.

#### Auto Reset Mode (Factory Setting)

Leave all three jumpers connected.

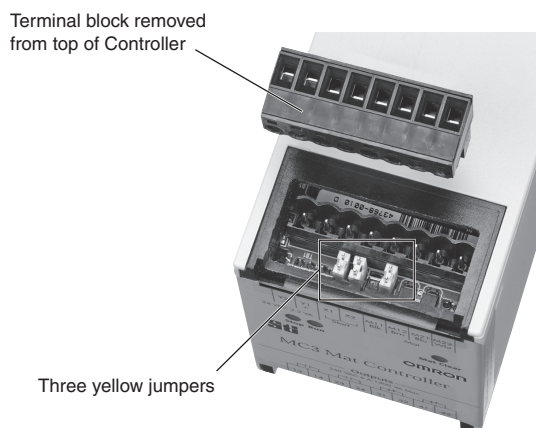

#### Manual Reset Mode

Remove all three jumpers.

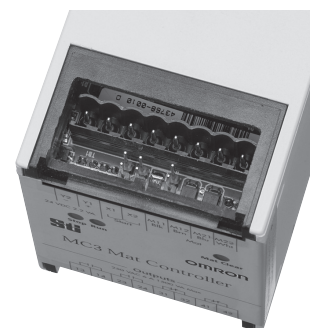

# UM/MC3

## Dimensions

(Unit: mm)

### Safety Mat Controller MC3

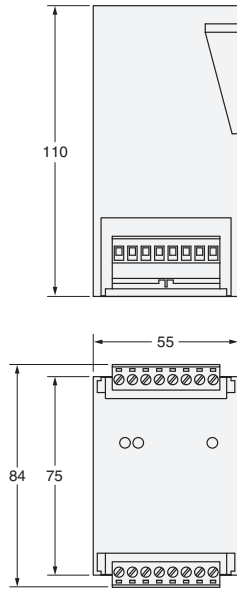

### Terminal/LED arrangements

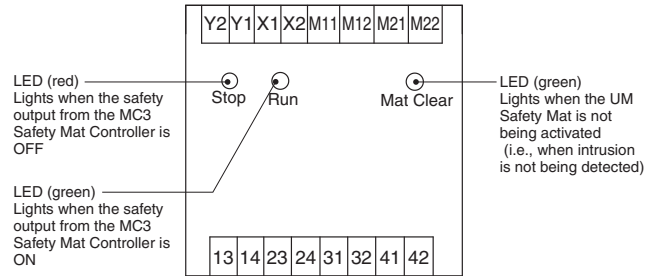

### Trims

#### Ramp Trim with Yellow PVC Cover UMRT

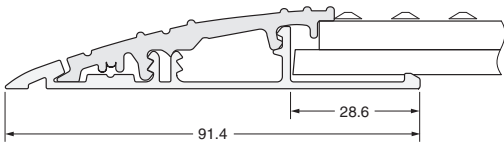

#### Joining Trim UMJS

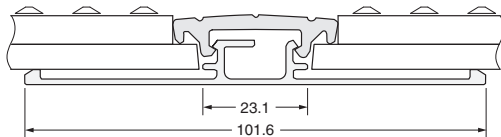

#### Aluminum Ramp Trim UMAL

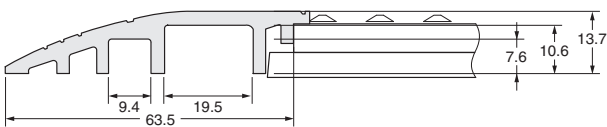

#### Molded Outside Corner UMOC

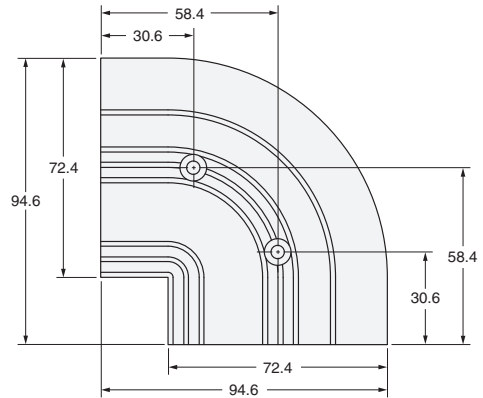

#### Molded Inside Corner UMIC

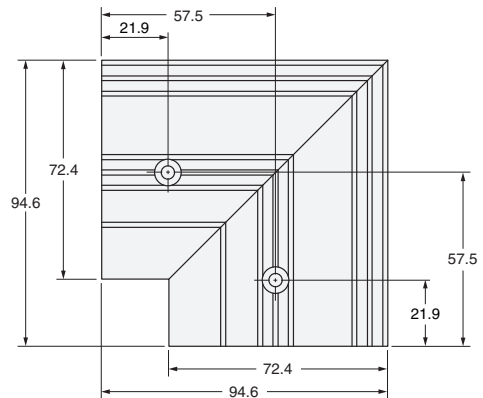

### Safety Mat

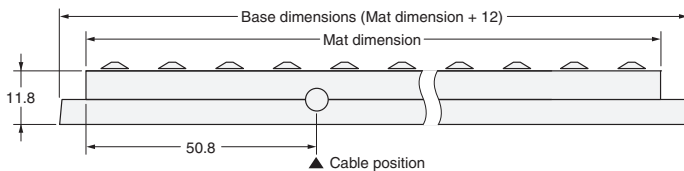

#### Example: UMYM5-0500-0500



Accessories

Distribution Box  
UMDB-6

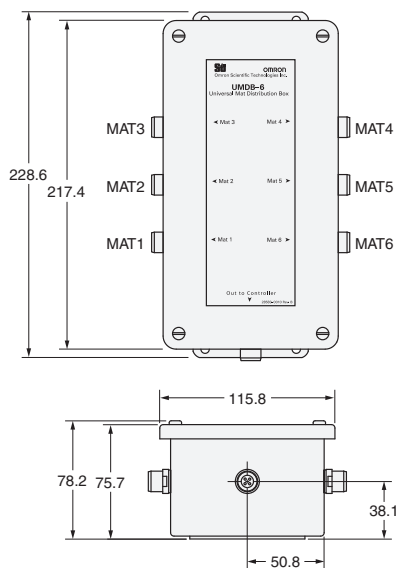

Mounting hole dimensions

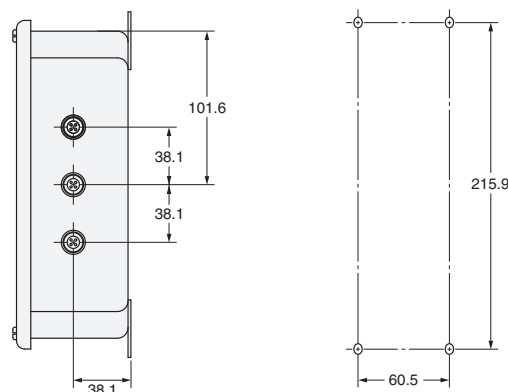

Y Connector  
UM-Y-2-1



Internal wiring

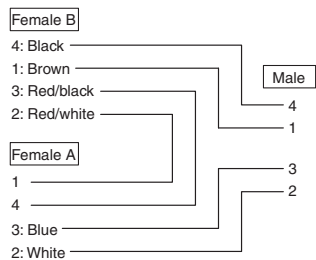
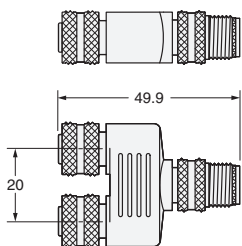

Panel-mount Connector  
UMPMC



Pin arrangement

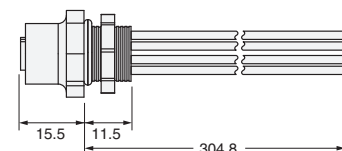
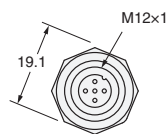

Extension Cable  
UMEC-03, UMEC-05  
UMEC-10, UMEC-15

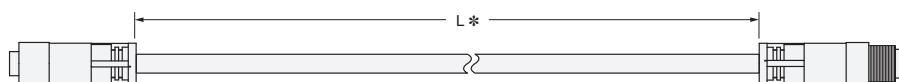

\*Cable length

Model	L (m)	Model	L (m)
UMEC-03	3	UMEC-05	5
UMEC-10	10	UMEC-15	15

Pin arrangement

Female (socket)

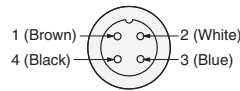

Male (plug)

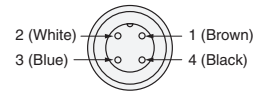

Connector with Cable Socket on One Cable End

XS2F-D421-C80-F  
XS2F-D421-D80-F  
XS2F-D421-G80-F  
XS2F-D421-J80-F

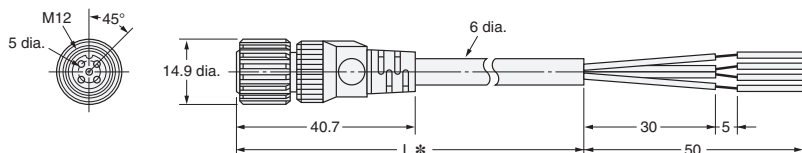

\*Cable length

Model	L (m)
XS2F-D421-C80-F	1
XS2F-D421-D80-F	2
XS2F-D421-G80-F	5
XS2F-D421-J80-F	10

Wiring diagram

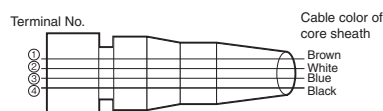

Pin arrangement

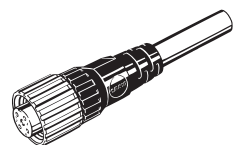
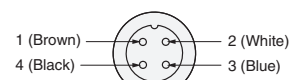

# UM/MC3

## Application Examples

Highest achievable PL/ safety category	Model	Stop category	Reset
PLd/3 equivalent	Safety Mat UM series Mat Controller MC3	0	Manual

**Note:** The above PL is only the evaluation result of the example. The PL must be evaluated in an actual application by the customer after confirming the usage conditions.

### Application Overview

- The power supply to the motor M is turned OFF when a person steps on the mat.
- The power supply to the motor M is kept OFF until the reset switch S1 is pressed after the person steps out of the mat.

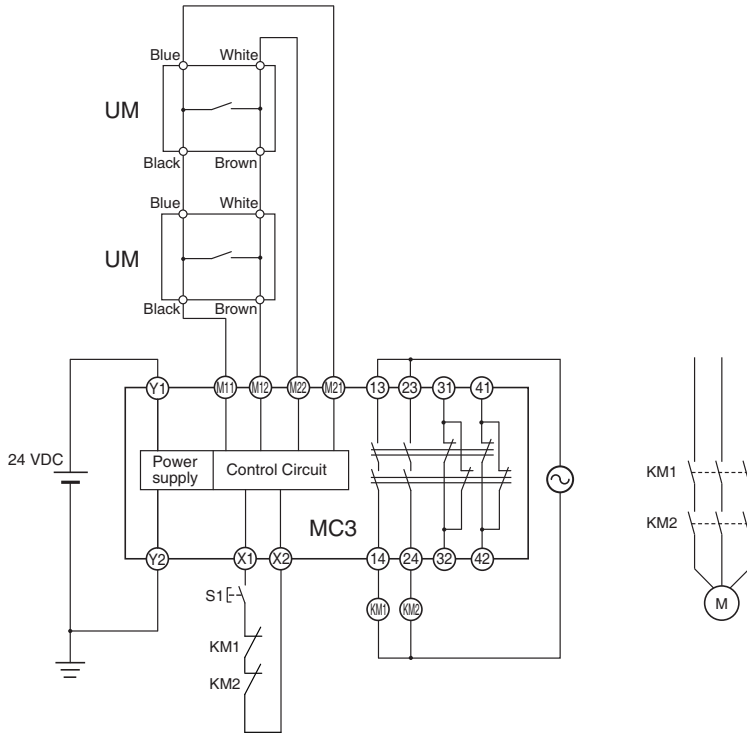

S1: Reset switch  
 KM1, KM2: Magnetic contactor  
 M: Motor

### Timing Chart

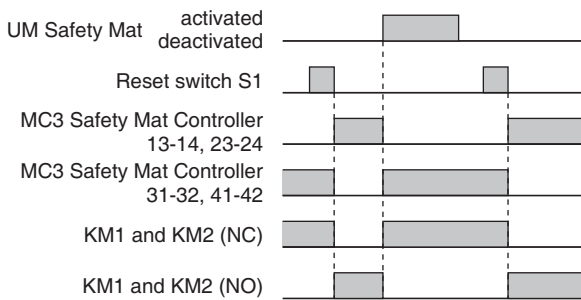

- Note:**
- Determine Mat dimensions based on safe distances. Refer to *Safety Precautions* on page 14 for the information on calculating safe distances.
  - Remove the three yellow jumpers from the MC3 to use Manual Reset Mode. Refer to *Changing the Reset Mode* on page 9 for the location of the jumpers.

Highest achievable PL/ safety category	Model	Stop category	Reset
PLd/3 equivalent	Safety Mat UM series Mat Controller MC3 Safety Relay Unit G9SA-301	0	Auto

**Note:** The above PL is only the evaluation result of the example. The PL must be evaluated in an actual application by the customer after confirming the usage conditions.

### Application Overview

- The power supply to the motor M is turned OFF when a person steps on the mat.
- The power supply to the motor M is kept OFF until the person steps out of the mat.

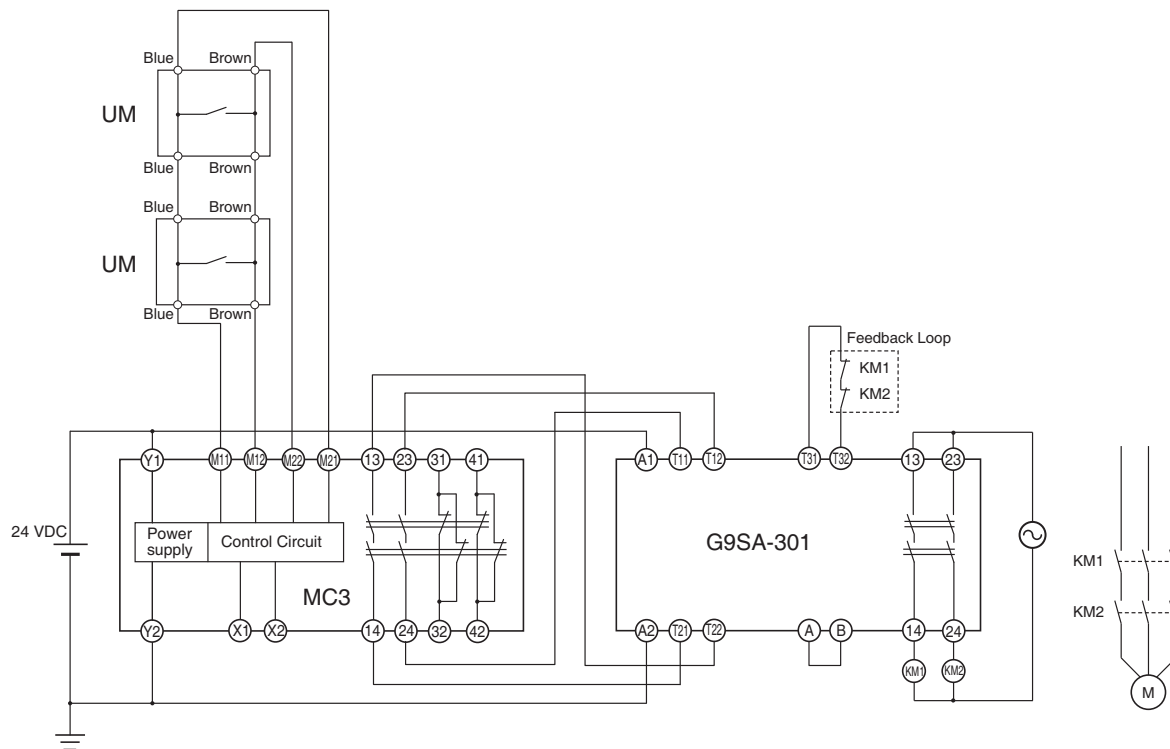

KM1, KM2: Magnetic contactor  
M: Motor

### Timing Chart

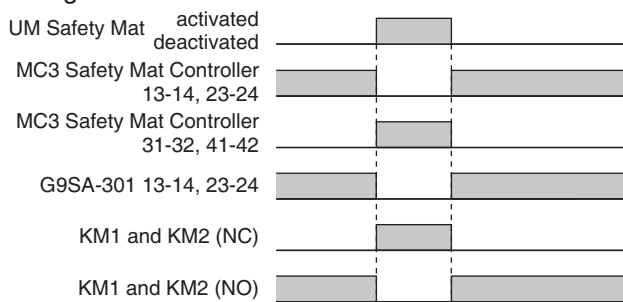

- Note:**
1. Determine Mat dimensions based on safe distances. Refer to *Safety Precautions* on page 14 for the information on calculating safe distances.
  2. Remove the three yellow jumpers from the MC3 to use Manual Reset Mode. Refer to *Changing the Reset Mode* on page 9 for the location of the jumpers.

## Safety Precautions

Before installing and using the Safety Mat System, carefully read the instruction manual attached to the product.

### WARNING

Serious injury may occur due to breakdown of safety outputs. Do not connect loads beyond the rated value to the safety outputs.



Serious injury may occur due to loss of required safety functions. Do not use the Safety Mat with logics that the operation of the mat might turn ON the guarded equipment. Use the Safety Mat with logics by which safety outputs turn OFF in a hazardous state.



Serious injury may occur due to loss of required safety functions. Wire the Safety Mat properly so that supply voltages or voltages for loads do NOT touch the safety inputs accidentally or unintentionally.



Serious injury may occur due to loss of required safety functions. Do not use a Safety Mat to detect children as it does not support child detection.



To use a Safety Mat for the purpose of entry detection, secure the following safety distance until a person reaches a hazardous area by walking on the mat. Otherwise, the machine may not stop before the person reaches the hazardous area, causing injury.



### Calculation of the Minimum Safety Distance

The ISO13855 standards provide the following formula to calculate the

minimum safety distance for floor-installed Safety Mats:

$$S = (1,600 \times T) + 1,200 \text{ mm}$$

In this equation, S is the minimum safety distance (unit: mm), the term 1,600 represents a standard approach speed of 1,600 mm/s, T is the overall stop time required for the machinery to stop, and the term 1,200 mm represents the length of a step and the length of an arm.

The overall stop time is comprised of two components:

$$T = t_1 + t_2$$

t<sub>1</sub> : Maximum response time from the activation of the detection device to the point that the control device's output goes OFF (30 ms for these Safety Mats).

t<sub>2</sub> : Response time of the machinery, i.e., the time required to stop the machine or remove the risk after receiving the output signal from the Safety Mat System.

The worst case scenario for the response time of the machinery (t<sub>2</sub>) must be used in the formula. The actual response time depends on various factors such as the machinery being used, the operating mode, the product being processed, and the point in the control cycle at which the stop signal is received. If there are other factors that may affect the response time, such as brake wear, these factors must be taken into account as well.

### Example Calculation

In this example, the Safety Mats are used with machinery that has a measured worst-case response time of 0.485 s.

$$T = t_1 + t_2$$

$$= 30 \text{ ms} + 485 \text{ ms}$$

$$= 515 \text{ ms} = 0.515 \text{ s}$$

$$S = (1,600 \times 0.515) + 1,200 \text{ mm}$$

$$= 824 + 1,200 \text{ mm} = 2,024 \text{ mm}$$

Consequently, the Safety Mat must be installed at a minimum distance of 2,024 mm from the danger source.

- Note:**
1. Read the Instruction Sheet included with the Safety Mat System thoroughly for details on designing and installing the Safety Mat System to provide the minimum safety distance mentioned above.
  2. The Safety Mat's Ramp Trim and Molded Corner are not considered part of the Safety Mat's detecting area. Do not include the Ramp Trim and Molded Corner in the safety distance.

### Precautions for Safe Use

- Turn OFF the power supply before wiring. Also, do not touch any terminals (current-carrying parts) while the power is ON. Doing so may result in electric shock.
- Do not perform wiring when there is a risk of lightning. Doing so may result in electric shock.
- Apply properly specified voltages to the Safety Mat inputs. Applying inappropriate voltages cause the Safety Mat to fail to perform its specified function, which leads to the loss of safety functions or damages to the Safety Mat.
- Use a power supply of the specified voltage. Do not use power supplies with large ripples or power supplies that intermittently generate incorrect voltages.
- Do not use the Safety Mat for a load that exceeds the Safety Mat's switching capacity (contact voltage, contact current) or other contact ratings. Doing so will reduce the specified performance, causing insulation failure, contact welding, and contact failure, and the Safety Mat may be damaged or burnt.
- The durability of the Safety Mat depends greatly on the switching conditions. Confirm operation under the actual conditions in which the Safety Mat will be used. Make sure the number of switching operations is within the permissible range. If a Safety Mat is used after performance has deteriorated, it may result in insulation failure between circuits and burning of the Safety Mat itself.
- Do not use the Safety Mat where flammable gases or explosive gases may be present. Doing so may cause combustion or explosion due to Relay heating or arcing during switching.
- Do not drop or disassemble the Safety Mat. Doing so may reduce the product characteristics and may result in damage, electric shock, or burning.
- To prevent short-circuit or ground failure of the load, connect protection elements such as fuses. Not doing so may damage or burn the load.
- When installing trims, be careful not to get injured by the edge of the trim, etc.

## Precautions for Correct Use

Make sure to use the Safety Mat UM series in combination with the Safety Mat Controller MC series or the Safety Controller G9SP.

### Handle with care

1. Do not drop the Safety Mat to the ground or expose to excessive vibration or mechanical shocks. The Safety Mat may be damaged and may not function properly.
2. Do not apply loads on a certain location of the Safety Mat for a long period of time. It may damage the Safety Mat.
3. Do not use the Safety Mat submerged in water or in locations continuously subject to splashes of water.
4. Store the Safety Mat in a vertical (standing) position prior to install so that loads are not applied to the Safety Mat.

### Solvents

Adhesion of solvent such as alcohol, thinner, trichloroethane or gasoline on the product should be avoided. Such solvents make the marking on the Safety Mat illegible and cause deterioration of parts.

### Storage conditions of the Safety Mat

Do not store in such conditions stated below.

1. In direct sunlight
  2. At ambient temperatures out of the range of -37 to 66°C.
  3. At air pressure out of the range of 86 to 106 kPa.
  4. In corrosive or combustible gases
  5. With vibration or mechanical shocks out of the rated values.
  6. Under splashing of oil, chemicals
  7. In the atmosphere containing dust, saline or metal powder.
- The Safety Mat may be damaged and may not function properly.

### Storage conditions of the Safety Mat Controller

Do not store in such conditions stated below.

1. In direct sunlight
  2. At ambient temperatures out of the range of 0 to 55°C.
  3. At relative humidity out of the range of 90%RH or under such temperature change that causes condensation.
  4. At air pressure out of the range of 86 to 106 kPa.
  5. In corrosive or combustible gases
  6. With vibration or mechanical shocks out of the rated values.
  7. Under splashing of water, oil, chemicals
  8. In the atmosphere containing dust, saline or metal powder.
- The Safety Mat Controller may be damaged and may not function properly.

### Wiring of the Safety Mat Controller

1. Use the following to wire to the Safety Mat Controller
  - Stranded wire (Flexible wire): 0.2 to 2.5 mm<sup>2</sup>
  - Solid wire: 0.2 to 2.5 mm<sup>2</sup>
  - Strip the cover of wire no longer than 7 mm.
2. Tighten each screw with a specified torque of 0.4 to 0.5 N·m, or the Safety Mat Controller may malfunction or generate heat.
3. Ground the negative side of the power supply. A controller with the positive side grounding will not work.

### Mounting of multiple Safety Mat Controllers

1. In closely contacted mounting, the rated carry current is 3 A. Use at 3 A or less voltage.
2. When applying more than 3A, place the mats farther than 25 mm from the nearest MC3.

### Mounting of the Safety Mat Controller to DIN rails

Use end plates (PFP-M: sold separately) on both ends of MC3.

### Use of air valve

1. After installing a mat, loose the air valve on the surface of the mat for 30 seconds or more in order to make the internal air pressure equal to external air pressure. Then, close the air valve.
2. Turn the air valve with a torque at 1.5 N·m or less.
3. Do not store or use the the mat with loose air valve. It may allow water penetration.

### Mounting of the Safety Mat

1. Use- dedicated trims to secure the circumference of the Safety Mat for installation.
2. Do not install the Safety Mat on an environment with a projection. Install it on a flat surface.
3. Do not pull the cables to lift or move the Safety Mat.
4. Do not use the Safety Mat with a cover on it.

### Others

This is a Class A product (Product in industrial setting). Use of the product in residential setting may cause radio disturbance. In such case, take appropriate measures.

### Safety Category

Certification has been obtained for EN ISO13849-1: 2015 PLd/Safety Category 3 for a system consisting of combination with the Safety Mat Controller MC series or the Safety Controller G9SP.

If you use a UM Safety Mat and MC3 Safety Mat Controller which is selected automatic reset mode, a separate safety controller is required to achieve a category 3, PLd safety circuit if external safety relays or magnetic contactors are connected.

### Standards

UM-□/MC3  
 ISO13856-1  
 EN62061  
 EN ISO13849-1 PLd/Safety Category 3  
 IEC61508  
 EN60204-1





---

**MEMO**



# Terms and Conditions Agreement

## Read and understand this catalog.

Please read and understand this catalog before purchasing the products. Please consult your OMRON representative if you have any questions or comments.

## Warranties.

- (a) Exclusive Warranty. Omron's exclusive warranty is that the Products will be free from defects in materials and workmanship for a period of twelve months from the date of sale by Omron (or such other period expressed in writing by Omron). Omron disclaims all other warranties, express or implied.
- (b) Limitations. OMRON MAKES NO WARRANTY OR REPRESENTATION, EXPRESS OR IMPLIED, ABOUT NON-INFRINGEMENT, MERCHANTABILITY OR FITNESS FOR A PARTICULAR PURPOSE OF THE PRODUCTS. BUYER ACKNOWLEDGES THAT IT ALONE HAS DETERMINED THAT THE PRODUCTS WILL SUITABLY MEET THE REQUIREMENTS OF THEIR INTENDED USE.

Omron further disclaims all warranties and responsibility of any type for claims or expenses based on infringement by the Products or otherwise of any intellectual property right. (c) Buyer Remedy. Omron's sole obligation hereunder shall be, at Omron's election, to (i) replace (in the form originally shipped with Buyer responsible for labor charges for removal or replacement thereof) the non-complying Product, (ii) repair the non-complying Product, or (iii) repay or credit Buyer an amount equal to the purchase price of the non-complying Product; provided that in no event shall Omron be responsible for warranty, repair, indemnity or any other claims or expenses regarding the Products unless Omron's analysis confirms that the Products were properly handled, stored, installed and maintained and not subject to contamination, abuse, misuse or inappropriate modification. Return of any Products by Buyer must be approved in writing by Omron before shipment. Omron Companies shall not be liable for the suitability or unsuitability or the results from the use of Products in combination with any electrical or electronic components, circuits, system assemblies or any other materials or substances or environments. Any advice, recommendations or information given orally or in writing, are not to be construed as an amendment or addition to the above warranty.

See <http://www.omron.com/global/> or contact your Omron representative for published information.

## Limitation on Liability; Etc.

OMRON COMPANIES SHALL NOT BE LIABLE FOR SPECIAL, INDIRECT, INCIDENTAL, OR CONSEQUENTIAL DAMAGES, LOSS OF PROFITS OR PRODUCTION OR COMMERCIAL LOSS IN ANY WAY CONNECTED WITH THE PRODUCTS, WHETHER SUCH CLAIM IS BASED IN CONTRACT, WARRANTY, NEGLIGENCE OR STRICT LIABILITY.

Further, in no event shall liability of Omron Companies exceed the individual price of the Product on which liability is asserted.

## Suitability of Use.

Omron Companies shall not be responsible for conformity with any standards, codes or regulations which apply to the combination of the Product in the Buyer's application or use of the Product. At Buyer's request, Omron will provide applicable third party certification documents identifying ratings and limitations of use which apply to the Product. This information by itself is not sufficient for a complete determination of the suitability of the Product in combination with the end product, machine, system, or other application or use. Buyer shall be solely responsible for determining appropriateness of the particular Product with respect to Buyer's application, product or system. Buyer shall take application responsibility in all cases.

NEVER USE THE PRODUCT FOR AN APPLICATION INVOLVING SERIOUS RISK TO LIFE OR PROPERTY OR IN LARGE QUANTITIES WITHOUT ENSURING THAT THE SYSTEM AS A WHOLE HAS BEEN DESIGNED TO ADDRESS THE RISKS, AND THAT THE OMRON PRODUCT(S) IS PROPERLY RATED AND INSTALLED FOR THE INTENDED USE WITHIN THE OVERALL EQUIPMENT OR SYSTEM.

## Programmable Products.

Omron Companies shall not be responsible for the user's programming of a programmable Product, or any consequence thereof.

## Performance Data.

Data presented in Omron Company websites, catalogs and other materials is provided as a guide for the user in determining suitability and does not constitute a warranty. It may represent the result of Omron's test conditions, and the user must correlate it to actual application requirements. Actual performance is subject to the Omron's Warranty and Limitations of Liability.

## Change in Specifications.

Product specifications and accessories may be changed at any time based on improvements and other reasons. It is our practice to change part numbers when published ratings or features are changed, or when significant construction changes are made. However, some specifications of the Product may be changed without any notice. When in doubt, special part numbers may be assigned to fix or establish key specifications for your application. Please consult with your Omron's representative at any time to confirm actual specifications of purchased Product.

## Errors and Omissions.

Information presented by Omron Companies has been checked and is believed to be accurate; however, no responsibility is assumed for clerical, typographical or proofreading errors or omissions.

**Note : Do not use this document to operate the Unit.**

**OMRON Corporation    Industrial Automation Company**  
Kyoto, JAPAN

**Contact: [www.ia.omron.com](http://www.ia.omron.com)**

**Regional Headquarters**

**OMRON EUROPE B.V.**

Wegalaan 67-69, 2132 JD Hoofddorp  
The Netherlands  
Tel: (31)2356-81-300/Fax: (31)2356-81-388

**OMRON SCIENTIFIC TECHNOLOGIES INC.**

6550 Dumbarton Circle Fremont  
CA 94555 U.S.A.  
Tel: (1) 510-608-3400/Fax: (1) 510-744-1442

**OMRON ASIA PACIFIC PTE. LTD.**

No. 438A Alexandra Road # 05-05/08 (Lobby 2),  
Alexandra Technopark,  
Singapore 119967  
Tel: (65) 6835-3011/Fax: (65) 6835-2711

**OMRON (CHINA) CO., LTD.**

Room 2211, Bank of China Tower,  
200 Yin Cheng Zhong Road,  
PuDong New Area, Shanghai, 200120, China  
Tel: (86) 21-5037-2222/Fax: (86) 21-5037-2200

**Authorized Distributor:**

© OMRON Corporation 2008-2017 All Rights Reserved.  
In the interest of product improvement,  
specifications are subject to change without notice.

**CSM\_9\_2\_1018**  
**Cat. No. F087-E1-02**

0917(1008)