

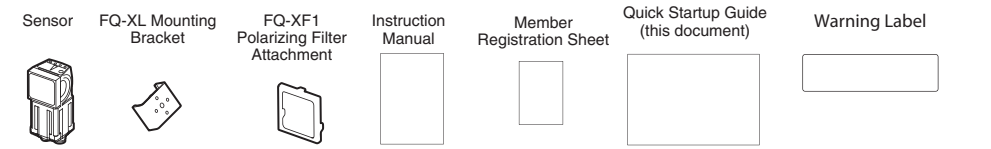

Box Contents

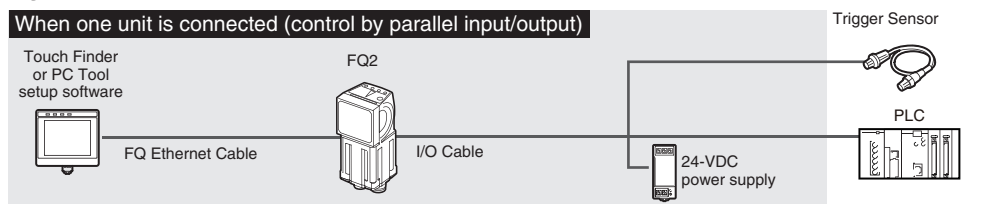

System Overview



Multiple Connections

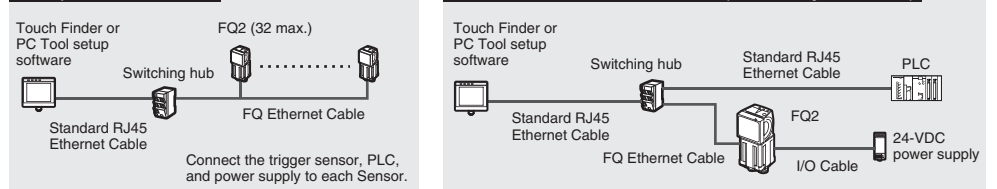

Product	Model number	Remarks
Sensor	FQ2-CH1□□□□□-M	This is the Vision Sensor.
Touch Finder	FQ2-D□□	This is a setup console.
PC Tool	---	The PC Tool can be used instead of the Touch Finder. If you register as a member, you can download the free PC Tool as a special service to purchasers. Refer to the Member Registration Sheet for member registration procedures and the download procedure for special member software.
FQ Ethernet Cable	FQ-WN0□□	Connects the Sensor to the Touch Finder or computer.
Standard RJ45 Ethernet Cable	---	Connects the switching hub to the Touch Finder or computer. (STP (shielded twisted-pair) cable, category 5e or 6, impedance: 100 Ω)
I/O Cable	FQ-WD0□□	Connects the Sensor to the power supply, and external devices.

Flow of Operation

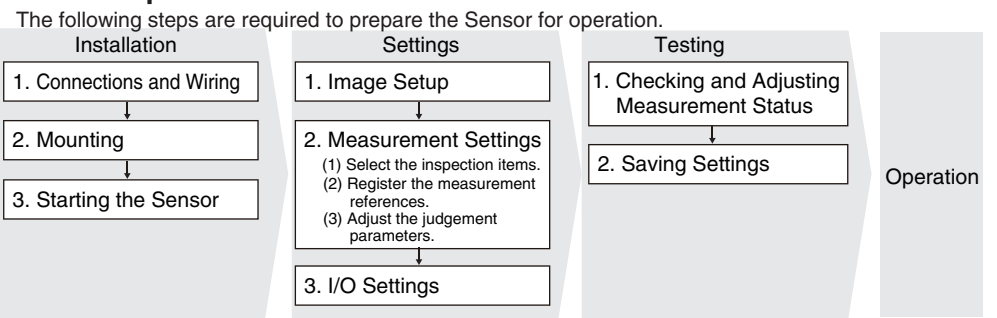

1. Installation

1-1 Connections and Wiring

1 Connect the Sensor to the Touch Finder or Computer via the FQ-WN0□□ Ethernet Cable.

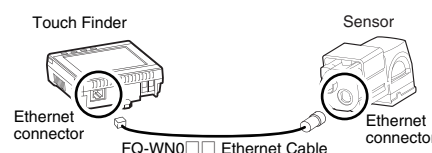

2 Connect the I/O Cable to the Sensor.

The I/O Cable includes lines for the power supply and I/O. Connect the required lines.

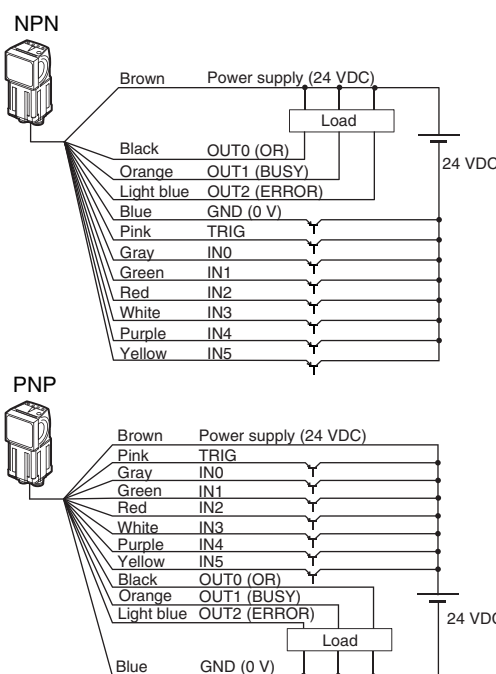

I/O	Signal	Function
Inputs	TRIG	Measurement trigger input (single)
	IN0 to IN5	Command input
Outputs	OUT0 (OR)	Overall judgement output
	OUT1 (BUSY)	Indicates that processing is in progress.
	OUT2 (ERROR)	Indicates an error has occurred.

Example 1

Here, measurements are performed when the trigger signal is input and the overall judgement is output.

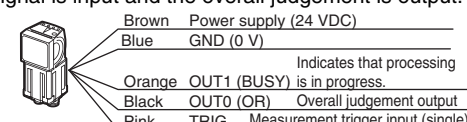

The TRIG signal is not received while the BUSY signal is ON. Turn ON the TRIG signal while the BUSY signal is OFF.

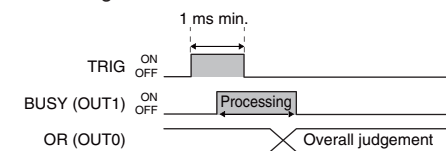

Important

- When brightness correction mode is ON, the brightness is stable but a delay of 25 ms occurs. Refer to the *User's Manual* for details. (FQ2-CH1□□□□□-M)
- Use a no-contact output device (e.g., SSR or PLC transistor output) for the TRIG signal. If a contact (e.g., relay) is used, contact bound may cause the trigger to be input again during execution of a measurement.

Example 2

Here, a process switching signal is input from an external device to switch the scene.

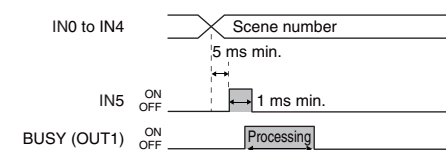
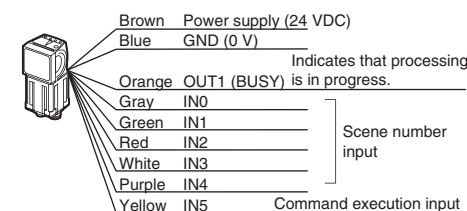

3 Connect a power supply to the Touch Finder.

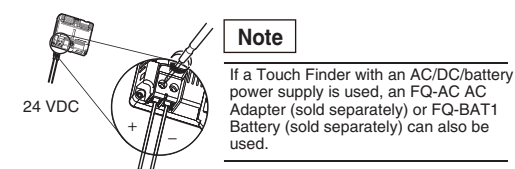

1-2 Mounting

1 Check the mounting position. Use the optical charts in the *User's Manual* and check the installation distance to be sure it is suitable for the field of view to be measured.

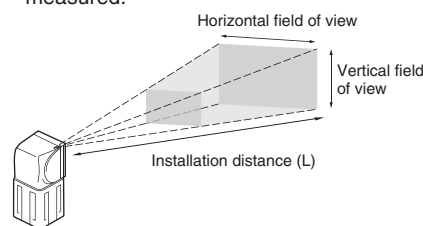

The horizontal field of view is given in the optical chart. The vertical field of view depends on the model of the Sensor as follows:

- FQ2-CH1□□□□□-M: Approx. 60% of the horizontal field of view

Example: FQ2-CH10□□□□□-M
For a 30-mm field of view, the Sensor must be installed at an installation distance of 115 mm.

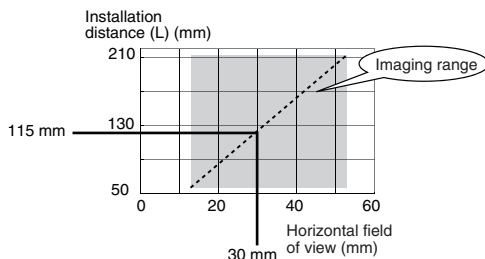

2 Attach the Mounting Bracket to the Sensor and mount the Sensor at the correct position.

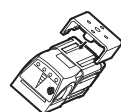

Installing the PC Tool

To use the PC Tool, register as a member, download the PC Tool, and install the PC Tool on your computer. Use the following network settings on your computer if you connect the computer directly to the Sensor. If you connect the computer and Sensor through a hub using a DHCP server, the following IP address does not need to be set.

- IP address: 10.5.5.101
- Subnet mask: 255.255.255.0

1-3 Starting the Sensor

1 Power ON the Sensor.

2 Power ON the Touch Finder.

Turn ON the power switch on the side of the Touch Finder, too.

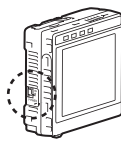

To use the PC Tool, click [Program] - [OMRON] - [FQ] - [PC tool for FQ] from the Windows Start Menu.

Select the language to display on the Touch Finder.



If more than one Sensor is connected, a display will appear to select the Sensor to be set. Select the Sensor.

The following initial display will appear when the Sensor is selected.

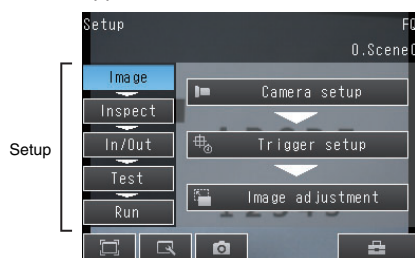

2. Settings

2-1 Image Setup

Make sure the image is stable and adjust the brightness and image input timing.

1 Focus the image.

Press [Camera setup].



The camera image will be displayed.



The higher the value, the better the focus.

Use the focus adjustment screw on the top of the Sensor to focus the image.

Focus adjustment screw



2 Adjust the brightness.

Adjust the shutter speed so that the Sensor can capture images of the measurement object at a suitable brightness. If the display is still dark, increase the gain.

Press [Left] and then [Shutter speed].

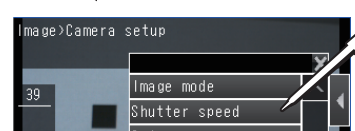

Adjust the shutter speed with the slider at the bottom of the display.

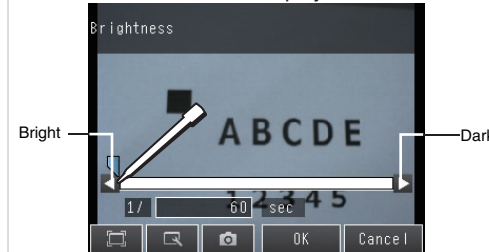

Press [OK].

Note

- Turning ON the [HDR] function improves the image quality for shiny objects. Refer to the *User's Manual* for details.
- Attach the enclosed Polarizing Filter if the image is blurred by reflections.

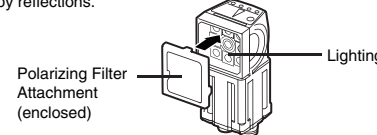

3 Adjust the image input timing.

Adjust the delay from when the trigger is input until the image is input. Press [Trigger setup].

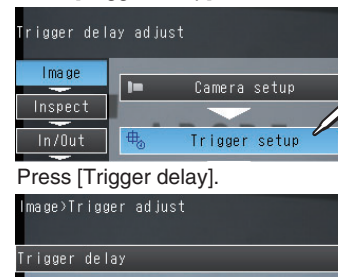

After the TRIG signal is input, images will be continuously input.



Select the image that was taken with the best timing. Press [OK].

4 Adjust the image.

Adjust the image that is taken by the Sensor to make it easy to measure. Here, the position is corrected by searching to enable measurements even if the position of the measurement object is not consistent.

Press [Image adjustment].

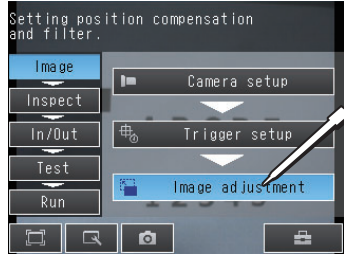

Press an unused number and then press [Add pos. comp.] on the menu.

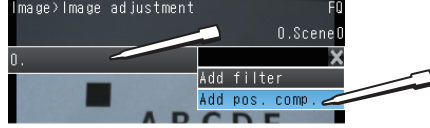

Press [Search position comp.].

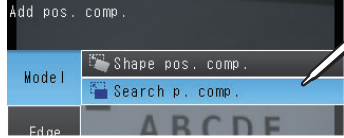

Press [Teach].



Place the object that is to be used as the measurement reference in front of the camera. Move the rectangle so that the characteristic part for position compensation is inside it.

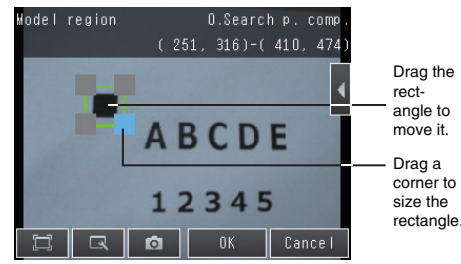

Check the area, press the [OK] Button, and then press the [TEACH] Button. The characteristic part and reference position for position compensation will be registered.

Press [OK].

You can add filter items to adjust the image to make it easier to measure. Refer to the *User's Manual* for details.

2-2 Measurement Settings

Select items for the desired measurement and register an image as the reference for the measurement.

1 Select the inspection items.

Example: Registering Optical Character Recognition as the Measurement Method

Press [Inspect] - [Inspection], press an unused item number, and then press [Add item.] - [OCR].

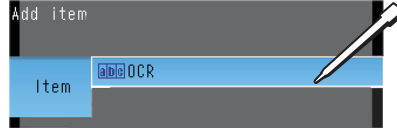

2 Register the measurement reference.

Specify the format of the characters to read (number of characters, alphanumeric characters or symbols, etc.) and specify the measurement region. Detailed parameters to recognize the characters will be set automatically.

Press [TEACH].

Place the object that is to be used as the measurement reference in front of the camera. Move the rectangle to the location to be measured, and then press the [OK] Button.

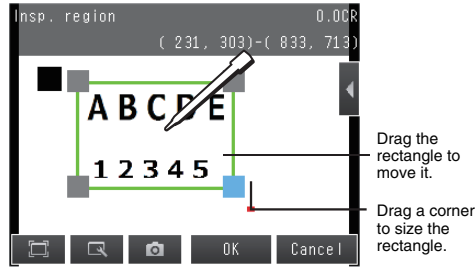

The characters that were read with the initial parameters and the character format will be displayed at the top of the display.

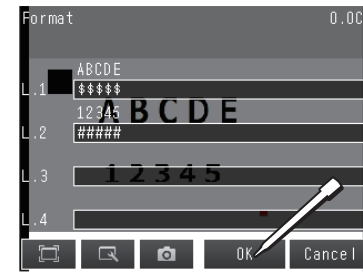

If necessary, change the character format. Refer to the *User's Manual* for details on the character format.

After you have confirmed the character format, press the [OK] Button. Then press the [TEACH] Button. The detailed parameters for character recognition will be set automatically according to the specified character format.

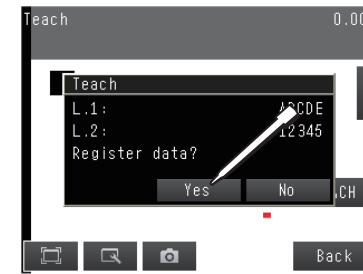

Press [Yes] to register the read result in the master data. Press [Back] to end teaching.

3 Adjust the judgement parameters.

Make the settings to check whether the characters that were read from the workpiece were recognized correctly.

Press [Judgement].

Adjust the judgement parameters while inputting images of several sample objects. Press the judgement condition parameter to adjust and set the upper and lower limits for an OK judgement.

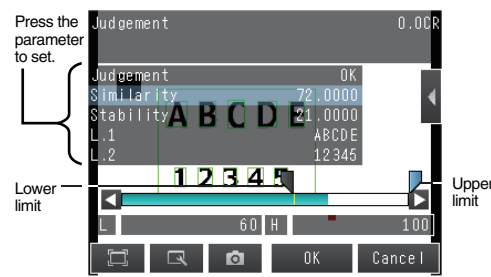

4 Set the verification conditions.

You can set these parameters to verify that the character string that was read matches a specific character string in the master data.

You can register up to 32 character strings in the master data with the following menu commands.

- [Auto]: Reads a character string from an image and registers it in the master data.
- [Manual]: Registers a character string that is entered directly in the master data.
- [Item ref.]: Specified to use the immediately preceding read result as the verification character string.

Refer to the *User's Manual* for details on the verification conditions.

2-3 I/O Settings

The data that is output to external devices and the input signal assignments can be changed. (Changes are not normally required.) For example, the following can be input or output.

- Judgements for individual inspection items can be output.
- Commands to register models can be input from an external device.
- If you want to output data externally

Refer to the *User's Manual* for details.

3. Testing

Tests are made with some samples to see if correct measurements are possible. When Test Mode is entered, images are measured continuously. A trigger input is not required. Measurement results are only displayed. They are not output to an external device.

1 Perform tests.

Press [Test].

Then press [Continuous test].

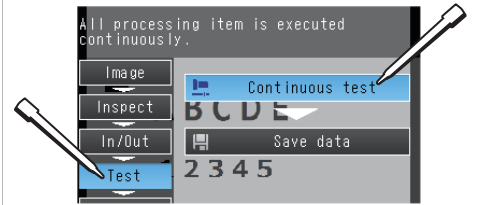

Press [Graphics+Details].



Continuous measurements will be performed. Input images of some samples to see if the judgements are correct.

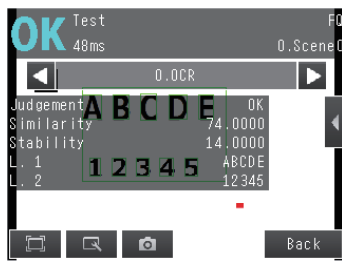

2 If correct judgements are not made, adjust the judgement parameters.

Press [Adjust judgement].

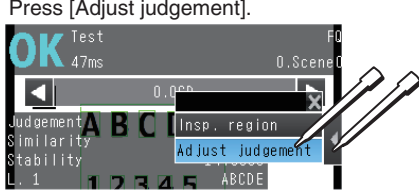

Press [Auto judgement].

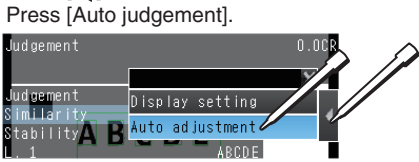

You can use prepared samples to automatically set the best judgement parameters. Input a sample of a good object and press [OK Teach]. Input a sample of a bad object and press [NG Teach]. Repeat these steps for at least two samples each.

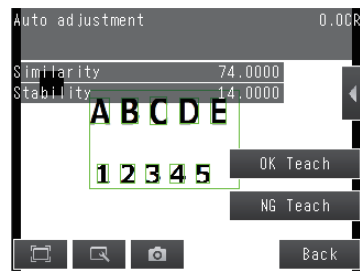

Press [Back].

The best judgement parameters will be set automatically.

4. Operation

1 Switch to the Run Mode display.

Press [Run]. Then press [Switch to Run mode].

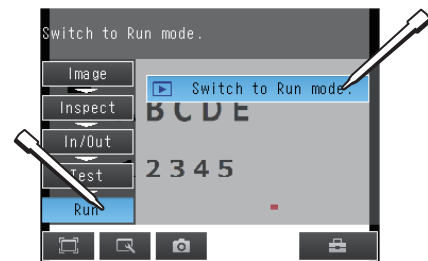

2 Save the settings.

Press [Yes].

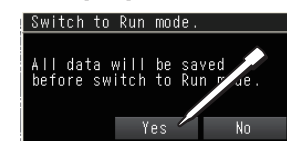

3 Execute measurements.

Measurements will be executed according to the trigger signal input. And the result of measurement will be output to an external device.

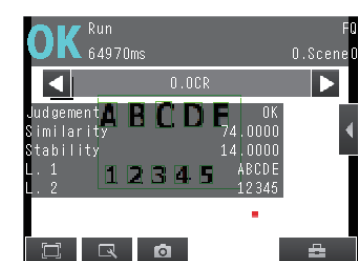

Note

There are six types of displays that can be used, as shown below. Press the [Sensor] Button and then press [Select display] to display the following selections.

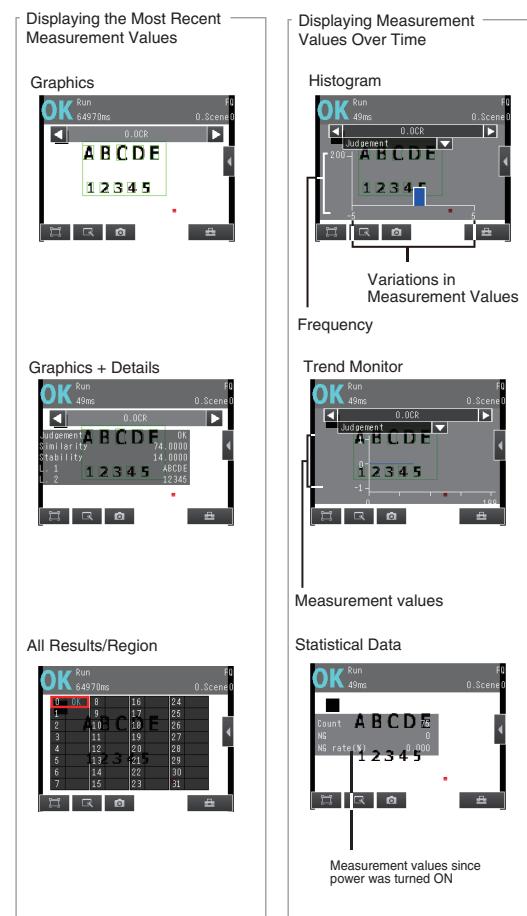

Note

- To return to the Setup Display, press the [Sensor] Button and then press [Sensor settings].
- To switch to another Sensor, press the [Sensor] Button and then press [Switch sensor].

Menu Structure

