

**INSTRUCTION SHEET**

Thank you for purchasing this OMRON product. This Instruction Sheet describes the functions, performance, and application methods required to use the H8BM.

- Observe the following precautions when using the H8BM.
- Make sure that a specialist with a knowledge of electrical systems operates the H8BM.
- Read and understand this Instruction Sheet, and be sure you understand the H8BM sufficiently before attempting to use it.
- Keep this Instruction Sheet close at hand and use it for reference during operation.

OMRON Corporation  
© All Rights Reserved.

3708333-4B

**Safety Precautions**

**Meanings of Alert Symbols**

**CAUTION** Indicates a potentially hazardous situation which, if not avoided, may result in minor or moderate injury or in property damage.

**Alert Statements**

<b>CAUTION</b>	Fire may occasionally occur. Tighten terminal screws securely to a tightening torque of 0.5 to 0.6 N·m.	!
	Minor electric shock, fire, or Product failure may occasionally occur. Do not disassemble, modify, or repair the Product or touch the interior of the Product.	⚡
	Minor electric shock, fire, or Product failure may occasionally occur. Do not allow any pieces of metal or conductors or any clippings or cuttings resulting from installation work to enter the Product.	⊘

**Precautions for Safe Use**

- In order to ensure safe operation, be sure to observe the following points.
- Store the Counter within the specified temperature range. If the Counter has been stored at a temperature under -10°C, allow the Counter to stand at room temperature for at least 3 hours before using it.
  - Use the Counter within the ratings specified for ambient operating temperature and ambient operating humidity.
  - Do not operate the Counter in any of the following locations.
    - Locations subject to sudden or extreme changes in temperature.
    - Locations where high humidity may result in condensation.
  - Use the Counter within the specified ratings for vibration and shock.
  - Do not use the Counter in locations subject to excessive dust, corrosive gases, or direct sunlight.
  - When using the Counter in environments subject to large amounts of static electricity (e.g., pipes carrying molding materials, powders, or fluid materials), separate the Counter as far as possible from the sources of static electricity.
  - Use the Counter within the specified ratings for vibration, shock, water immersion, and exposure to oil.
  - Always use a thermo-switch on the load circuit when a heater is used.
  - Do not use organic solvents (such as paint thinner or benzene), strong alkalis, or strong acids because they will damage the external finish of the Counter.
  - Install a switch or circuit breaker that allows the operator to immediately turn OFF the power, and label it to clearly indicate its function.
  - Be sure that all terminals are wired correctly.
  - Do not connect more than two crimp terminals to the same terminal.

- Use the specified wires for wiring.
  - Applicable Wires: AWG22 to AWG14 (cross-sectional area of 0.326 to 2.081 mm<sup>2</sup>)
  - Solid or twisted wires of copper
- Always maintain the load current within specifications.
- Use a switch, relay, or other contact device to turn OFF the power supply instantaneously. Outputs may malfunction and memory errors may occur if the power supply voltage is decreased gradually.
- Up to two wires of the same size and type can be inserted into a single terminal.
- Separate the input devices, input wiring, and Counter as far as possible from sources of noise and power lines carrying noise.
- The life of internal parts may be reduced if Counters are mounted in close proximity to each other.
- Maintain voltage fluctuations in the power supply within the specified range.
- Use a switch, relay, or other contacts so that the rated power supply voltage will be reached within 0.1 s. If the power supply voltage is not reached quickly enough, the power source may fail to reset or the outputs may fail to operate correctly.
- Do not leave the Counter for long periods at a high temperature with output current in the ON state. Doing so may result in the premature deterioration of internal components (e.g., electrolytic capacitors).
- Periodically inspect and replace the rubber packing. It may deteriorate, expand, shrink, or harden in some operation environments.
- Check that the backlight, output indicators, and LCD are operating normally. Some operating environments may accelerate deterioration of the indicators, LCD, and resin components and cause display malfunctions. Periodically inspect and replace parts.
- Be sure that the voltage applied is within the specified range; otherwise, the internal elements of the Counter may be damaged.

**Installation and Panel Dimensions**

**Dimensions (Unit: mm)**

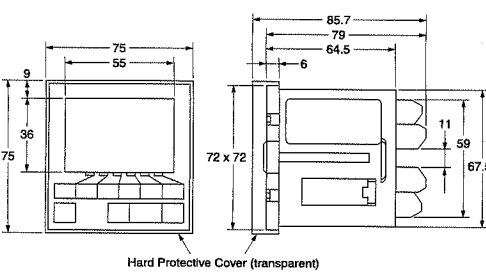

**Installation Diagram (Unit: mm)**

To mount the Counter, attach the two supplied brackets to the left and right sides of the Counter, and securely tighten the knurled screws on the brackets by hand, keeping the Counter balanced on the right and left. The performance may not be satisfactory if the screws are loose or excessively tightened. If the knurled screws are excessively tightened with pliers or other tool, damage may result.

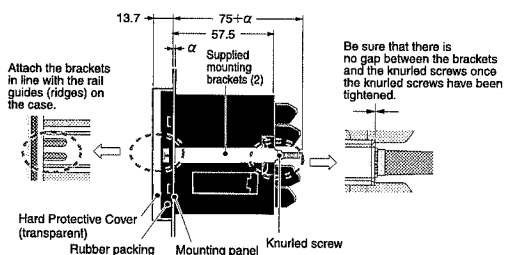

The panel cutout is as shown below (according to DIN 43700). The mounting panel thickness must be 1 to 5 mm. Mount the Counter so that the ambient temperature will not exceed 55°C.

Provide enough space around the Counter when mounting it to ensure a proper working space.

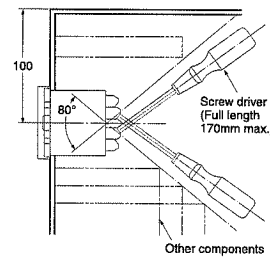

**Precautions for Correct Use**

- Be sure that the capacity of the power supply is sufficient. The Counter may not start due to the capacity of the power supply or the inrush current that may flow for an instant (approx. 1.6 A for 12 ms) when the Counter is turned ON.
- EEPROM is used to back up the memory if the power fails. Data can be written to EEPROM 100,000 times. Data is written to the EEPROM when the settings are changed or deleted or the power is turned OFF.
- The Counter uses a constant read-in system, so outputs will turn ON if the set values are changed during operation such that the set value is equal to or less than the count value.
- Dispose of the Counter in accordance with all local industrial waste disposal procedures.
- The water and oil resistance will be lost if the front sheet is peeled off or torn. Do not use the Counter if the front sheet is peeled or torn.
- Conformity to Safety Standards (To conform to IEC/EN Standards) This is a class A product. In residential areas it may cause radio interference, in which case the user may be required to take adequate measures to reduce interference.

**Connections**

**Connections**

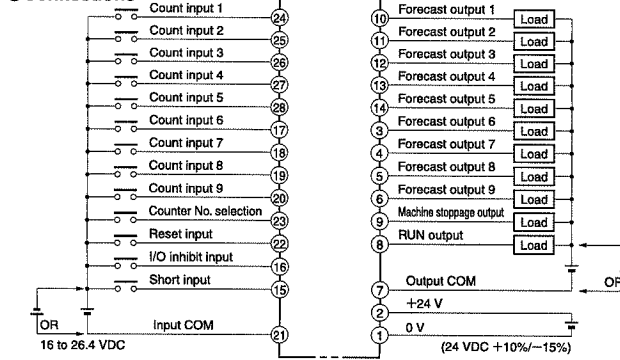

Output method	RUN output, machine stoppage output, and forecast outputs 1 to 9
Switching capacity	Open collector
Residual voltage	30 VDC max., 100 mA max.
Leakage current	2 VDC max.
	100 μA max.

Note 1. When the load is short-circuited, the internal circuits may be damaged.  
Note 2. Connect a diode to suppress Counter surge when an inductive load is connected.

**Terminal Arrangement**

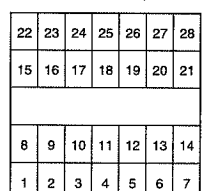

M 3x5 screws are used. Select solderless terminals referring to the figure below.



**Ratings**

Rated supply voltage	24 VDC
Operating voltage range	85% to 110% of rated supply voltage
Power consumption	Approx. 1.7 W (at 26.4 VDC)
Max. counting speed	30 Hz for count inputs 1 to 7 Switchable between 30 Hz and 500 Hz for count inputs 8 and 9
One-shot time	20 ms
Voltage input	High level: 16 to 26.4 VDC, Low level: 0 to 3 VDC (Input resistance: Approx. 2.2 kΩ)
Surrounding air temperature	-10 to +55°C (with no icing or condensation)
Ambient storage temperature	-25 to +65°C (with no icing or condensation)
Ambient operating humidity	25% to 85%
Weight	Approx. 250 g (Counter only)
Degree of protection	IP54 Oil-proof type (Case front)
Vibration resistance (destruction)	10 to 55 Hz with 0.75-mm single amplitude 4 cycles each in 3 directions (8 min/cycle)
Vibration resistance (malfunction)	10 to 55 Hz with 0.5-mm single amplitude 4 cycles each in 3 directions (8 min/cycle)
Shock resistance (destruction)	300 m/s <sup>2</sup> 3 times each in 6 directions
Shock resistance (malfunction)	200 m/s <sup>2</sup> 3 times each in 6 directions

Surrounding Air Temperature according to UL508 45°C

**I/O Connections**

**Input Circuits**

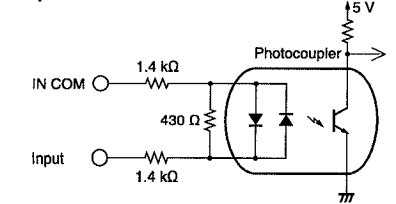

Note: Although the input terminals are electrically insulated from the internal circuit, do not conduct an insulation resistance test on these terminals.

**Output Circuits**

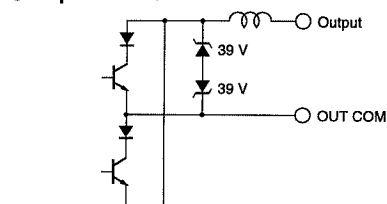

Note: Although the output terminals are electrically insulated from the internal circuit, do not conduct an insulation resistance test on these terminals.

**Nomenclature for Front Section**

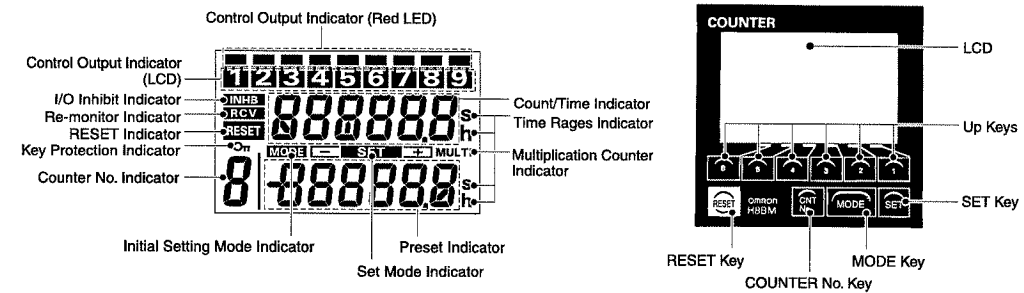

**Example of Input Connections**

**Solid-state Switches**

**Two-wire Sensor**

The count input, counter number selection, reset input, I/O inhibit input, and short input signals are input when the two-wire Sensor turns ON.

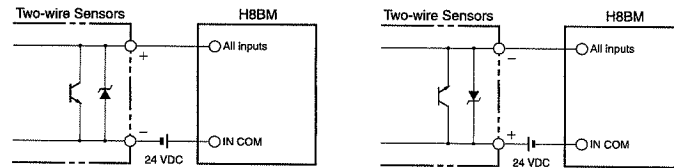

Note: Use the following two-wire Proximity Sensors:  
1. High-level: transistor ON  
Switching capacity: 5 mA min.  
Residual voltage: 4 VDC max.  
2. Low-level: transistor OFF  
Leakage current: 1.5 mA max.  
3. Operating voltage range: 20.4 to 26.4 VDC  
We recommend using OMRON E2E-X□□-N Sensors.

**Three-wire Sensor**

**• NPN Type**

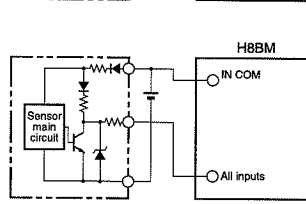
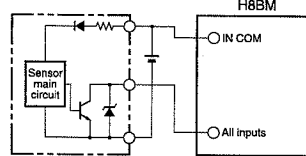

**• PNP Type**

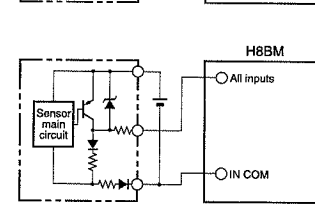
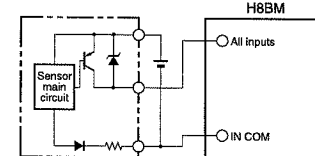

**Contact Switch Connection**

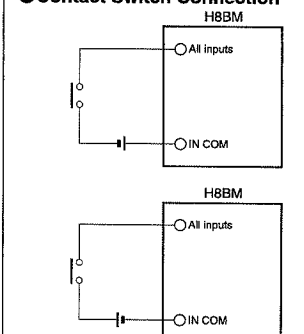

Note: H: Contact ON.  
Use contact which can adequately switch 13 mA at 30 V.

**Operating Methods**

**Timing Charts**

**1. Counter (3-stage Preset Operation)**

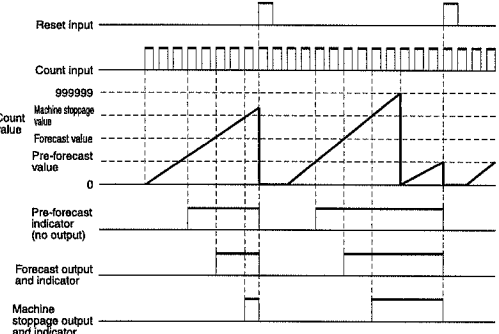

**2. Timer (3-stage Preset Operation)**

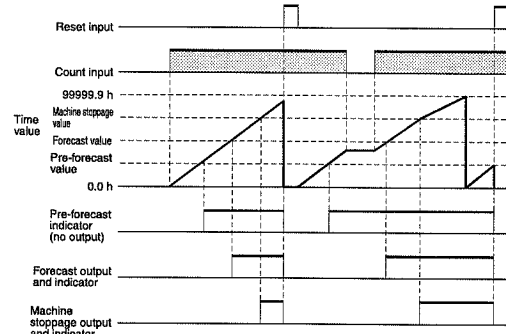

**3. Total Counter Operation**

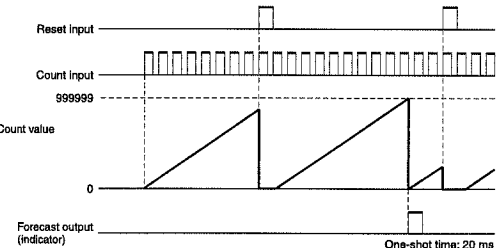

**4. Total Timer Operation**

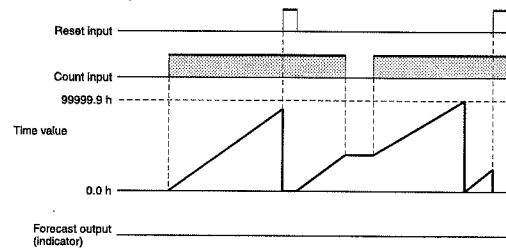

Note: The count will return to 0 when 999999 is exceeded.

**Power Supply**

- The power supply, input, and output circuits are electrically isolated inside the Counter.
- When turning the power ON and OFF, input signal reception is sometimes possible, sometimes not possible, and sometimes unstable, as shown in the diagram below.

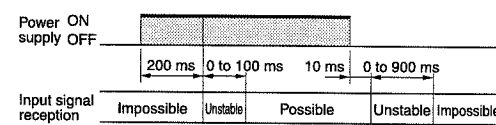

- Turn on or off the operating power source all at once by using switch or relay contact.

**SUITABILITY FOR USE**

You must allow sufficient leeway in ratings and performance and provide proper fail-safe and other safety measures when using the Unit in any of the following applications. Be sure also to consult with your OMRON representative before actually attempting any of these applications.

- Applications under conditions or environments not specified in user manuals.
- Applications for nuclear reactor control, train facilities, aviation facilities, motorized vehicles, furnaces, medical equipment, amusement equipment, and safety equipment.
- Applications strongly related to human life or property, particularly those requiring safety.

**OMRON**

OMRON EUROPE B.V.  
Wegalaan 67-69, P.O. BOX 13 2130 AA  
HOOFDDORP THE NETHERLANDS  
(Wegalaan 67-69, 2132 JD Hoofddorp, The Netherlands)  
PHONE 31-2356-81-300 FAX 31-2356-81-388

OMRON ELECTRONICS, LLC.  
1 East Commerce Drive, Schaumburg Illinois 60173 U.S.A  
PHONE 1-847-843-7900 FAX 1-847-843-8568 / 7787

OMRON ASIAPACIFIC PTE.LTD.  
510 Thomson Road # 13-03 SLF Building,  
Singapore 298135 SINGAPORE  
PHONE 65-353-2611 FAX 65-353-5391

Note: Specifications subject to change without notice.  
Printed in Japan

### 1. DIP Switch Settings

Key protection and whether each counter operates as a counter or a timer are specified on a DIP switch provided on the side panel of the Counter. Open the cover of the switch compartment on the side of the Counter to access the DIP switch.

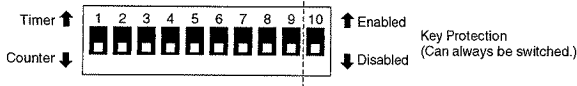

Note: Set the DIP switch (except for Key Protection) before turning ON the power. Changes to DIP switch settings while the Counter is operating will be ignored. Power must be turned OFF then back ON after changing the settings. Changes to DIP switch settings are also enabled when changing to initial setting mode because the same operation is performed as when cycling the power.

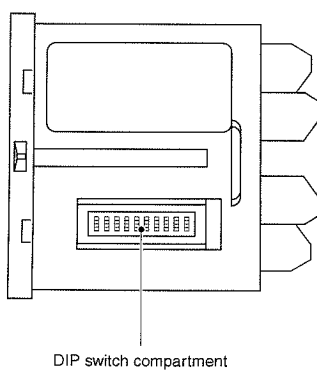

DIP switch compartment

### 2. Changing Mode

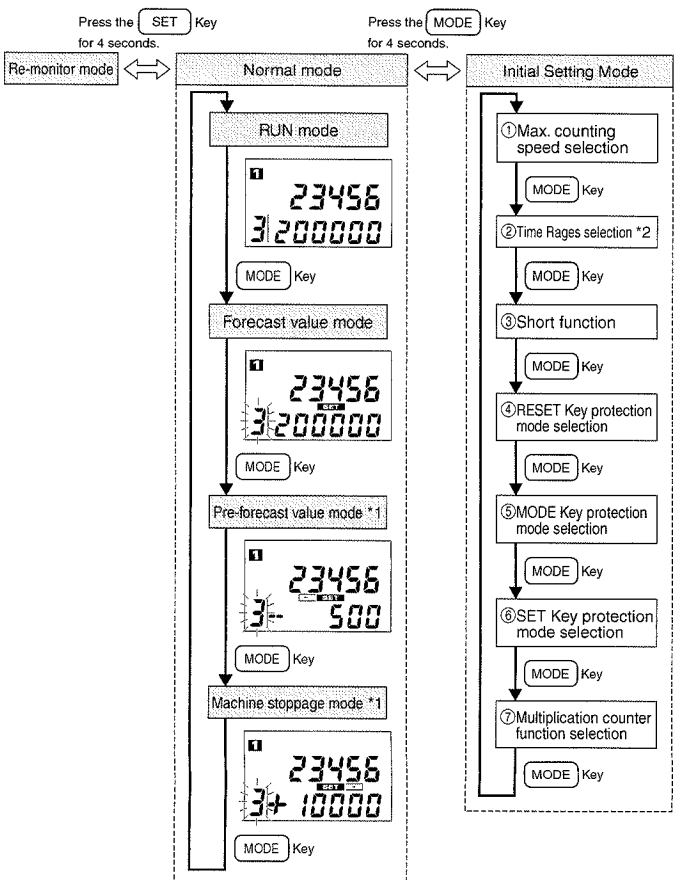

\*1. The modes marked \*1 are not provided on the 1-stage type Counter.  
\*2. The time unit selection for initial setting mode is displayed when the Counter functions as a timer. (It is not displayed when the Counter functions as a counter.)

Note: I/O operations are always performed regardless of the mode. If no key is pressed for 1 minute in each mode, the RUN mode is automatically restored.

will flash.

### Setting and Changing Pre-forecast Values

- Press the **MODE** Key to enter the pre-forecast value setting mode.
  - The same counter number as in the forecast value setting mode is displayed after changing to pre-forecast value mode.
  - "-" is automatically displayed.
- Press the **COUNTER No.** Key (or turn ON the counter number selection input) to select the Counter whose data is to be set or changed.
  - Next, press the **UP** Key (**1** to **5**) to set or change the pre-forecast value.
  - The **COUNTER No.** Key does not need to be pressed if the counter does not need to be changed.
- Press the **SET** Key to enter the set value.
  - If no key is pressed within 5 seconds after the **SET** Key has been pressed, the RUN mode is automatically restored.

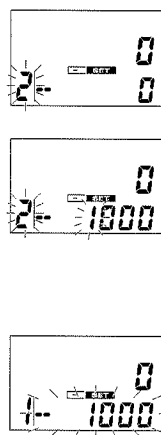

### Setting and Changing the Machine Stoppage Value

- Press the **MODE** Key to enter the Machine Stoppage Value setting mode.
  - The same counter number as in the pre-forecast value setting mode is displayed after changing to machine stoppage value setting mode.
  - "+" is automatically displayed.
- Press the **COUNTER No.** Key (or turn ON the counter number selection input) to select the Counter whose data is to be set or changed.
  - Next, press the **UP** Key (**1** to **5**) to set or change the machine stoppage value.
  - The **COUNTER No.** Key does not need to be pressed if the counter does not need to be changed.
- Press the **SET** Key to enter the set value.
  - If no key is pressed within 5 seconds after the **SET** Key has been pressed, the RUN mode is automatically restored.

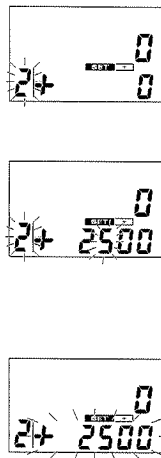

### 4. Special Set Values

#### Setting Counters That Will Not Use the Machine Stoppage Output

The machine stoppage output will not be used for counters for which the machine stoppage value has been set to +99999 (+9999.9 h/+9999.9 s).

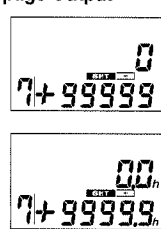

#### Setting Counters That Will Not Be Used

Input and output operations will not occur for counters for which the forecast value has been set to 0 (0.0 h/0.0 s).  
If the forecast value is set to 0 (0.0 h/0.0 s), the pre-forecast and machine stoppage values will automatically be set to 0 (0.0 h/0.0 s).

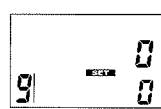

#### Setting Counters To Be Used as Total Counters/Timers

Counters can be used as total counters/timers if the forecast value for that counter is set to 99999 (99999.9 h/99999.9 s).  
The machine stoppage output will no longer be output for that counter.  
When using a counter as a total counter, the forecast output for that counter when the count value changes from 999999 to 0 will be a one-shot output of 20 ms to indicate a carry.

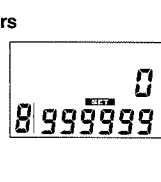

### 5. Checking Count Values (RUN Mode)

Press the **COUNTER No.** Key (or turn ON the counter number selection input) in RUN mode to check the count value for each counter.

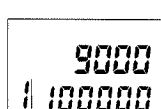

The counter number changes in sequence each time the **COUNTER No.** Key is pressed (or the input turns ON), from 1 through 9 then back to 1.

\* However, any counter whose forecast value is set to 0 (0.0 h/0.0 s) will be skipped.

### 6. Other Indicators

#### Timer Operation Display

The period on the count value display will flash while the count input is ON and the Timer is in h mode.  
The timer operation measures time by totaling the ON time of the count input.

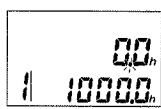

### 7. Deleting Count Values

#### (1) Resetting Individual Counters

- Press the **COUNTER No.** Key (or turn ON the counter number selection input) to select the Counter to be reset.
  - The counter value can be reset in all modes except initial setting mode and re-monitor mode.
- Press the **RESET** Key (or turn ON the reset input) to reset the count value to 0 for that counter only.

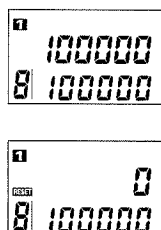

#### (2) Resetting of All Counters at the Same Time

Press and hold both the **COUNTER No.** and **RESET** Keys for 3 seconds to reset the count value for all counters to 0.  
The same operation is achieved by simultaneously turning ON the counter number selection and reset inputs for 3 seconds.

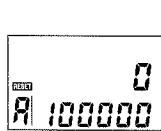

### 8. All Clear

Press and hold the **RESET** and **SET** Keys for 3 seconds to reset the count values, pre-forecast values, forecast values, and machine stoppage values to 0 for all counters.  
The counter number after All Clear has been executed will automatically change to 1.

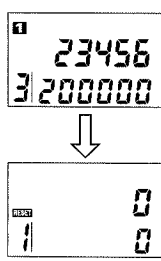

### 9. Control Output Display

The pre-forecast value, forecast, and machine stoppage status display will be as follows:

#### Pre-forecast Values

The output display for counters for which the count value has reached the pre-forecast set value will lit.  
Pre-forecast values are only displayed as a message and are not output.

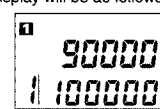

#### Forecast Outputs

A red indicator will light at the top of the output display section for the lit counter number and the output will turn ON.



#### Machine Stoppage Output

The entire background will alternate between red and green and the output display for the counter with a machine stoppage will flash.



Note: If the pre-forecast, forecast, or machine stoppage output turns ON, the counter number display will automatically change to that number and the count value will be displayed (in RUN mode only).

### 10. Initial Setting Mode

#### 1. Max. Counting Speed Switching

The max. counting speed switching for counters 8 and 9 can be changed.

- Press the **UP** Key to switch between 30 Hz and 500 Hz.
- Press the **SET** Key to enter the set value.



#### 2. Time Rages

The Timer time rages can be changed.

- Press the **COUNTER No.** Key to change the time rages.

Select the counter number.

- Press the **UP** Key to switch between 0.1 h and 0.1 s.
- Press the **SET** Key to enter the set value.

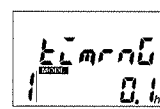

Note: The time unit is displayed when the counter is set to a timer on the DIP switch.

#### 3. Short Function

Counter 1 inputs can be input to other counters.

- Press the **UP** Key and select the number of counters for which the short function is to be enabled.
- Press the **SET** Key to enter the setting.



Note: The short input is read only when the power is turned ON. They are ignored if input during operation.

ex. If "5" is selected, Counter 1 inputs can be input to counters 2 to 5.

#### 4. RESET Key Protection Mode

The RESET Key can be protected.

- Press the **UP** Key and select the counter for which RESET Key protection is to be set.
- Press the **SET** Key to enter the setting.



Note: The Reset of All Counters and All Clear using the RESET Key are disabled if the RESET Key Protection function is turned ON.

Note: Key Protection function is activated by setting the Dip Switch to 10.

#### 5. MODE Key Protection Mode

The MODE Key can be protected.

- Press the **UP** Key to switch between "off" and "on".
- Press the **SET** Key to enter the setting.

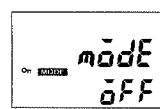

Note: Key Protection function is activated by setting the Dip Switch to 10.

#### 6. SET Key Protection Mode

The SET Key can be protected.

- Press the **UP** Key to switch between "off" and "on".
- Press the **SET** Key to enter the setting.

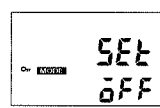

Note: Key Protection function is activated by setting the Dip Switch to 10.

#### 7. Multiplication Counter

- Press the **UP** Key to switch between "off" and "on".
- Press the **SET** Key to enter the setting.



### 11. Re-monitor Mode

- Hold the **SET** Key for 4 seconds to change to re-monitor mode.
  - The previous values that have been reset will be displayed.
  - Only the display changes. Internal counting operations are not affected.
  - The counter number remains unchanged on RUN display when the mode is changed to re-monitor display.

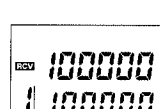

- Press the **COUNTER No.** Key (or turn ON the counter number selection input) to select the counter to be re-monitored.



- When the **RESET** Key is pressed (or the reset input turns ON), the re-monitor value and the counter number will flash 3 times and the only the count value for that counter will be returned to the value prior to being reset.

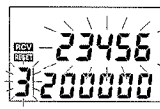

### 12. Self-diagnosis Function

The following displays are made when errors occur.

#### 1. CPU Errors

CPU errors occur when a runaway CPU is detected.  
All inputs and outputs are prohibited during CPU errors.  
Turn OFF the power or press the **RESET** Key to clear the error and restore the settings and count values to the values before the error.

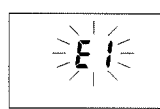

#### 2. Memory Errors

Memory errors occur when an error has been detected within the memory.  
All inputs and outputs are prohibited during memory errors.  
All settings (pre-forecast, forecast, and machine stoppage values) will be returned to 0.  
Turn OFF the power or press the **RESET** Key to clear the error and return the count values for all counters to 0.

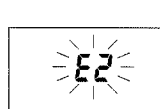

#### 3. Key Errors

Key errors occur when any key has been pressed and held continuously for 5 minutes.  
All inputs and outputs are prohibited during key errors.  
Turn OFF the power supply or press the **RESET** Key to clear key errors.

