

SYSMAC
H-PCF Optical Fiber Cables

INSTALLATION GUIDE

OMRON

SYSMAC

H-PCF Optical Fiber Cables

Installation Guide

Revised July 1993

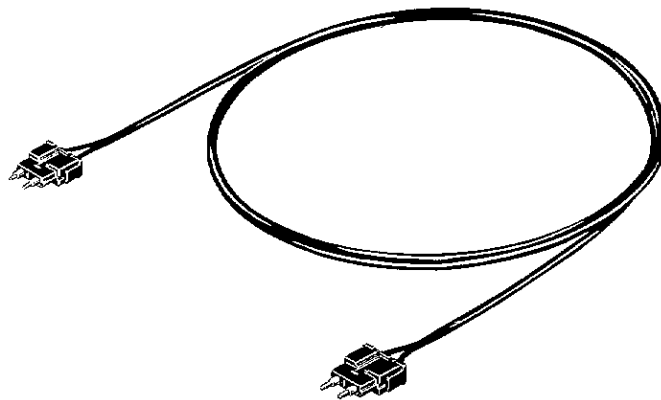

Notice:

OMRON products are manufactured for use according to proper procedures by a qualified operator and only for the purposes described in this manual.

The following conventions are used to indicate and classify precautions in this manual. Always heed the information provided with them. Failure to heed precautions can result in injury to people or damage to the product.

DANGER! Indicates information that, if not heeded, is likely to result in loss of life or serious injury.

WARNING Indicates information that, if not heeded, could possibly result in loss of life or serious injury.

Caution Indicates information that, if not heeded, could result in relative serious or minor injury, damage to the product, or faulty operation.

OMRON Product References

All OMRON products are capitalized in this manual. The word "Unit" is also capitalized when it refers to an OMRON product, regardless of whether or not it appears in the proper name of the product.

The abbreviation "Ch," which appears in some displays and on some OMRON products, often means "word" and is abbreviated "Wd" in documentation in this sense.

The abbreviation "PC" means Programmable Controller and is not used as an abbreviation for anything else.

Visual Aids

The following headings appear in the left column of the manual to help you locate different types of information.

Note Indicates information of particular interest for efficient and convenient operation of the product.

1, 2, 3... 1. Indicates lists of one sort or another, such as procedures, checklists, etc.

© OMRON, 1989

All rights reserved. No part of this publication may be reproduced, stored in a retrieval system, or transmitted, in any form, or by any means, mechanical, electronic, photocopying, recording, or otherwise, without the prior written permission of OMRON.

No patent liability is assumed with respect to the use of the information contained herein. Moreover, because OMRON is constantly striving to improve its high-quality products, the information contained in this manual is subject to change without notice. Every precaution has been taken in the preparation of this manual. Nevertheless, OMRON assumes no responsibility for errors or omissions. Neither is any liability assumed for damages resulting from the use of the information contained in this publication.

TABLE OF CONTENTS

SECTION 1	
Introduction	1
1-1 Introduction to H-PCF Optical Fiber Cables	2
1-2 Features of H-PCF Optical Fiber	3
SECTION 2	
H-PCF Cord and Cable Specifications	7
2-1 Component Materials and Dimensions	8
2-2 Specifications	10
2-3 Factory Inspection	12
SECTION 3	
Connectors for H-PCF Optical Fibers	13
3-1 Connectors	14
3-2 Connector Components	16
3-3 Connector Assembly	17
3-4 Optical Power Testing	19
SECTION 4	
H-PCF Cord and Cable Installation	23
4-1 Introduction	24
4-2 Installation Conditions	24
4-3 Basic Installation Methods	24
4-4 Installation Precautions	29
4-5 Securing the Cord or Cable	33
4-6 Increasing Cable Length	34
4-7 Connector Attachment	34
Appendices	
A Standard Models	35
Glossary	39
Index	41
Revision History	43

About this Manual:

This manual describes the installation of hard-clad PCF (H-PCF) Optical Fiber Cords and Cables and includes the sections described below. Information concerning individual components of the SYSMAC NET LINK, SYSMAC NET, SYSMAC BUS, SYSMAC BUS/2, and SYSMAC Host Link Systems can be found in their respective manuals.

Please read this manual carefully and be sure you understand the information provided before attempting to install Optical Fiber Cords or Cables.

WARNING Failure to read and understand the information provided in this manual may result in personal injury or death, damage to the product, or product failure. Please read each section in its entirety and be sure you understand the information provided in the section and related sections before attempting any of the procedures or operations given.

Section 1 introduces the special characteristics of Optical Fiber Cord and Cable and compares H-PCF optical fiber to earlier varieties.

Section 2 describes the components of H-PCF Optical Fiber Cords and Cables and provides specifications for the cords and cables.

Section 3 provides information on the dimensions, assembly, and testing of Optical Connectors used with H-PCF Optical Fiber Cords and Cables.

Section 4 describes how to install H-PCF Optical Fiber Cord and Cable in buildings and around equipment at building sites.

Appendix A provides ordering information for Optical Fiber Cords, Optical Fiber Cables, and related equipment.

SECTION 1

Introduction

This section introduces the special characteristics of Optical Fiber Cords and Cables and compares H-PCF optical fiber to earlier varieties.

1-1	Introduction to H-PCF Optical Fiber Cables	2
1-2	Features of H-PCF Optical Fiber	3

1-1 Introduction to H-PCF Optical Fiber Cables

On the outside, Optical Fiber Cords and Cables look like electrical cords and cables. However, instead of metal wires carrying electrical signals, Optical Fiber Cords and Cables use quartz-glass fibers with a hard-clad coating (hard acrylic fluoride plastic) to carry light signals. Optical signals travel through the glass fiber for distances up to 1 km. Though the plastic coating protects the glass fiber, Optical Fiber Cords and Cables require much greater care during handling and installation than conventional electrical cords and cables. It is very important to protect the cord and cable from impact, and care should be taken to avoid excessive bending or twisting of the cord and cable. The Optical Fiber Cords are intended for indoor use while the Optical Fiber Cables are intended for outdoor use.

The following diagram shows the construction of the SI-type (step index type) multimode optical fiber used in H-PCF Optical Fiber Cables. The optical fiber shown below consists of a quartz-glass fiber with a hard plastic coating.

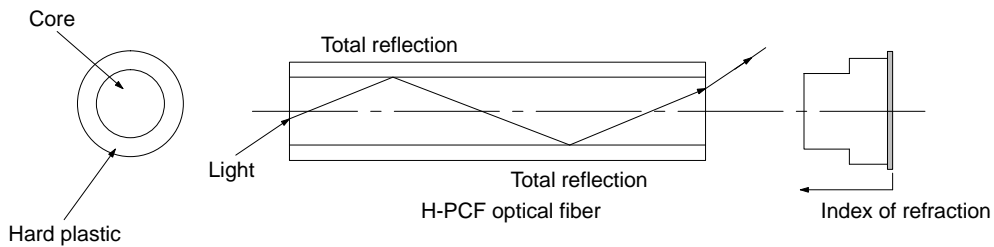

The H-PCF optical fiber's mechanical strength and resistance to temperature changes is increased by its soft fluoroplastic (ETFE) jacket. The following diagram compares the construction of the H-PCF hard-clad fiber (HC-20/07) to the older PCF silicon-clad fiber (PC-20/07).

HC-20/07 Hard-clad Fiber

PC-20/07 silicon-clad fiber

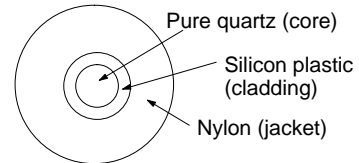
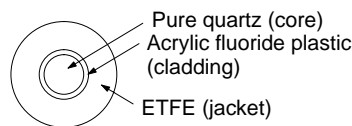

The following table compares the dimensions of H-PCF optical fiber (HC-20/07) to the older PCF optical fiber (PC-20/07).

Item	HC-20/07	PC-20/07
Core diameter	200 μm	
Plastic cladding diameter	230 μm	300 μm
Plastic cladding thickness	15 μm	50 μm
Total diameter (with jacket)	0.5 mm	0.9 mm
Numerical aperture (NA)	0.4	0.35

The following diagram shows the construction of single and dual-fiber cords:

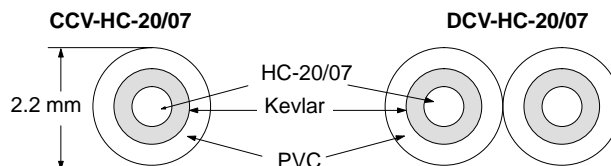

The following diagram shows the construction of the 2-C-V (2×CCV-HC-20/07):

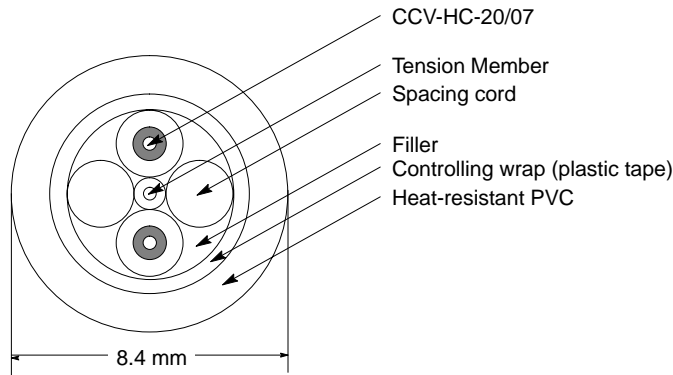

1-2 Features of H-PCF Optical Fiber

This section describes the basic features of H-PCF Optical Fiber Cables.

Signal Loss vs. Wavelength H-PCF optical fibers have a stable signal loss at a wavelength of about 0.8 μm. The signal loss for H-PCF is equal to or better than the low loss levels of the older PCF optical fibers (about 4 to 6 dB).

The following graph shows signal loss vs. wavelength for a 1 km CCV-HC-20/07 H-PCF Optical Fiber Cord at a temperature of 25°C (77°F).

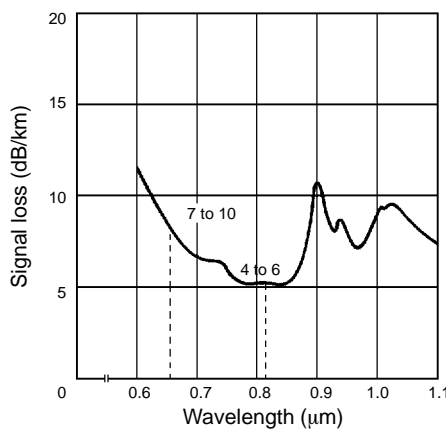

Signal Loss vs. Distance The maximum signal loss (α) for a given length (L) of two-fiber DCV-HC-20/07 optical fiber can be calculated from the following equations. Equation 1 is for a wavelength of 0.810 μm at a temperature of 25°C (77°F), and equation 2 is for a wavelength of 0.655 μm at a temperature of 25°C (77°F).

$$1) \alpha(L) \leq (7-4 \times \log(L)) \times L \text{ dB (for } \lambda = 0.810 \text{ } \mu\text{m and } T = 25^\circ\text{C)}$$

$$2) \alpha(L) \leq (15-4 \times \log(L)) \times L \text{ dB (for } \lambda = 0.655 \text{ } \mu\text{m and } T = 25^\circ\text{C)}$$

The following graph shows the signal loss vs. distance characteristics given by the equations above.

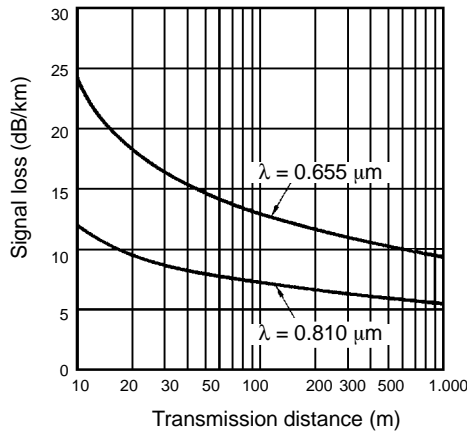

Numerical Aperture vs. Fiber Length

The H-PFC optical fibers have a high NA value that the older PFC optical fibers lacked, as well as more efficient light sources and connectors.

The following graph shows NA vs. distance for DCV-HC-20/07 H-PCF Duplex Optical Fiber Cord with EIA FOTP-47 (intensity method B) and a DF-1700 transmitter ($\lambda = 0.81 \mu\text{m}$).

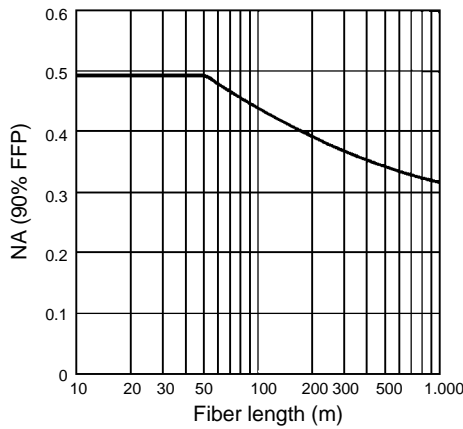

Band vs. Fiber Length

The following equation expresses the baseband frequency characteristics $f(L)$ in MHz for a given fiber length (L) in km.

$$f(L) = 14.5 \times L^{-0.89} \text{ MHz}$$

(for $0.85 \mu\text{m}$, $NA=0.4$, and spot size $\phi 200 \mu\text{m}$ min. full mode excitement)

The following graph shows transmission band vs. fiber length for DCV-HC-20/07 H-PCF Duplex Optical Fiber Cord with an LED light source of $\lambda = 0.85 \mu\text{m}$ and full mode excitement.

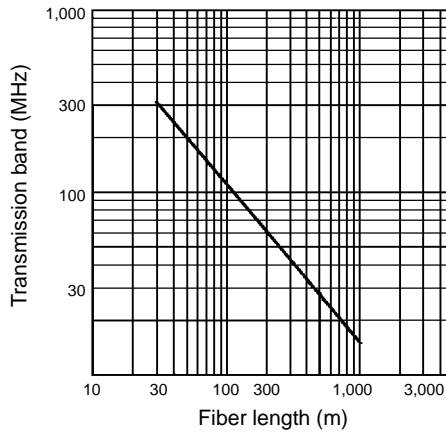

Signal Loss vs. Temperature

The following graph shows signal loss vs. temperature for the older silicon-clad PCF optical fibers (PC-20/07) and the H-PCF optical fibers (HC-20/07). Low temperature signal loss, which was a problem with the older PCF optical fibers, has been greatly reduced. A DF-1700 light source ($\lambda = 0.81 \mu\text{m}$) was used.

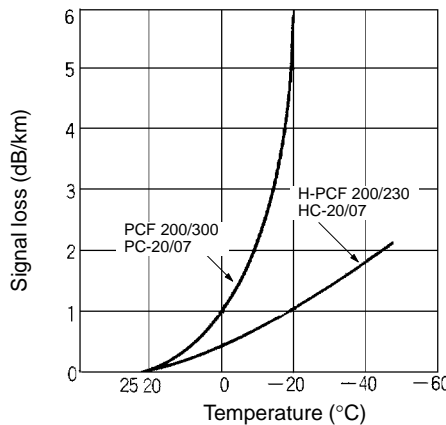

H-PCF Optical Fiber Connectors

Since the H-PCF optical fibers are hard-clad, it is possible to use crimp connectors as well as the older style that requires gluing and polishing. This is the most important characteristic of H-PCF optical fibers, and greatly simplifies the attachment of connectors.

SECTION 2

H-PCF Cord and Cable Specifications

This section describes the components of H-PCF Optical Fiber Cords and Cables and provides specifications for the cords and cables.

2-1	Component Materials and Dimensions	8
2-2	Specifications	10
2-3	Factory Inspection	12

2-1 Component Materials and Dimensions

These specifications apply to two-fiber H-PCF (hard plastic-clad optical fiber) Optical Fiber Cords and metallic-construction Optical Fiber Cables. Refer to *Appendix A Standard Models* for ordering information.

Two-fiber Optical Fiber Cord

The following diagram shows the construction of the two-fiber H-PCF Optical Fiber Cord. The quartz core diameter is 200 μm and the fiber diameter (including the hard plastic cladding) is 230 μm . Signal loss is 7 dB over 1 km.

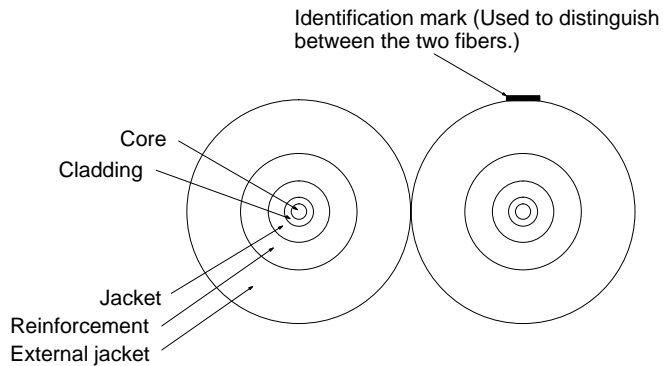

Component	Item	Specification
General	Fiber type	Plastic-clad multimode optical fiber
	Numerical aperture (NA)	Approximately 0.4
	Signal loss	7 dB over 1 km
	Weight	8 kg/km
Core	Material	Quartz glass
	Diameter	200 \pm 5 μm
	Circular eccentricity	6% max.
Cladding	Material	Acrylic fluoride plastic
	Diameter	225 \pm 5 μm
	Eccentricity	6% max.
Jacket	Material	Fluoride plastic
	Diameter	0.5 \pm 0.1 mm
Reinforcement	Material	High-tensile-strength aromatic fiber
External jacket	Material	Heat-resistant PVC (black)
	Diameter	2.2 \pm 0.2 mm \times 4.4 \pm 0.4 mm

Two-fiber Optical Fiber Cable

The following diagram shows the construction of the two-fiber H-PCF Optical Fiber Cable. The diagram on the left shows the S3200-HCC□□□□ cables, which do not have power supply wires. The diagram on the right shows the S3200-HCL□□□□ cables, which have power supply wires.

S3200-HCC□□□□

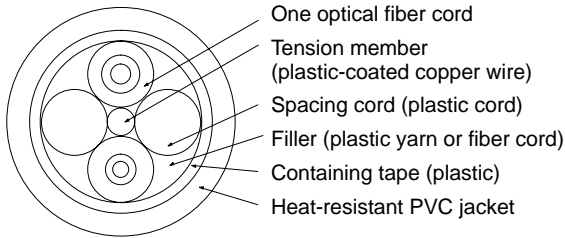

S3200-HCL□□□□

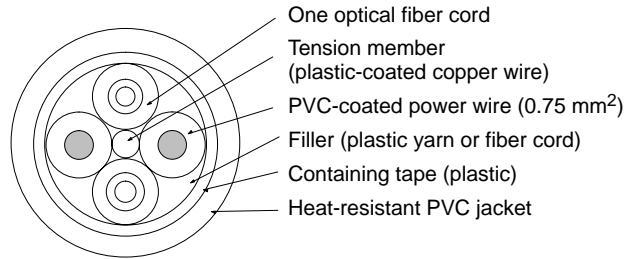

As shown in the following diagrams, one of the optical fiber cords in the cable is marked so that the user can distinguish between the cords. In the S3200-HCL□□□□ cables, one power wire is white and the other is red.

S3200-HCC□□□□

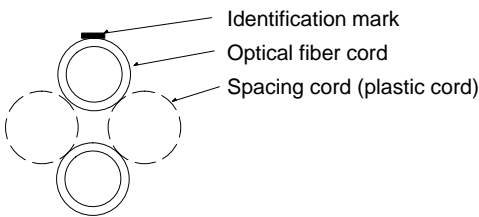

S3200-HCL□□□□

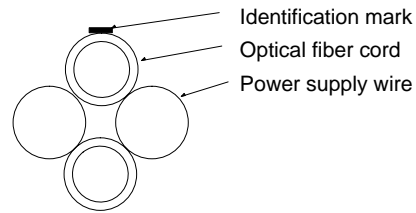

S3200-HCC□□□□ Cables

The following table shows the specifications for S3200-HCC□□□□ cables, which do not have power supply wires.

Component	Item	Specification
General	Cable diameter	8.4±1.0 mm
	Weight	70 kg/km
Optical fiber cord	Refer 2-2 <i>Specifications</i> for details on optical fiber cord specifications.	
Tension member	Material	Plastic-coated copper wire
	Diameter	Approx. 1.5 mm
Spacing cord	Material	Plastic
	Diameter	Approx. 2.2 mm
	Total diameter across both cords	Approx. 5.9 mm
External jacket	Material	PVC
	Thickness	1.2 mm

S3200-HCL□□□□ Cables

The following table shows the specifications for S3200-HCL□□□□ cables, which have power supply wires.

Component	Item	Specification
General	Cable diameter	8.6±1.0 mm
	Weight	85 kg/km
Optical fiber cord	Refer to 2-2 <i>Specifications</i> for details on optical fiber cord specifications.	
Power wire	External diameter	2.3 mm (approximate)
	Conductor cross-sectional area	0.75 mm ²
	Conductor composition	30/0.18 strands/mm
	Conductor diameter	Approx. 1.1 mm
	Insulator material	PVC
	Insulator thickness	0.6 mm
	Total diameter across both wires	Approx. 6.1 mm
Tension member	Material	Plastic-coated copper wire
	Diameter	Approx. 1.5 mm
External jacket	Material	PVC
	Thickness	1.2 mm

2-2 Specifications

These specifications apply to two-fiber H-PCF (hard plastic-clad optical fiber) Optical Fiber Cords and metallic-construction Optical Fiber Cables. Refer to *Appendix A Standard Models* for ordering information.

Mechanical Characteristics

Item	Specification			Comments
	DCV-HC-20/07 (Two-fiber cord)	2-C-V (Two-fiber cable)	2-C-2V-V (Two-fiber cable*)	
Operating temperature	-20°C to 70°C	-20°C to 70°C	-20°C to 50°C	---
Storage temperature	-40°C to 70°C	-40°C to 70°C	-40°C to 70°C	---
Maximum tensile load	25 kgf	75 kgf	75 kgf	Temporary tensile load.
Minimum bend radius	15 mm	25 mm	25 mm	Unintentional temporary bend, no load.
Crush resistance	200 kgf/50 mm	200 kgf/50 mm	200 kgf/50 mm	Temporary load.
Repetitive bend resistance	Cord: Mandrel diameter: 50 mm, 1 kg load, 180° bend 500,000 times Cable: Mandrel diameter: 100 mm, 1 kg load, 180° bend 500,000 times			No breaks
Repetitive twist resistance	Cord: 200 mm, ±90° twist 500,000 times Cable: 100 mm, ±45° twist 500,000 times			
Repetitive squeeze resistance	Cord: Mandrel diameter: 100 mm, 2 kg load, 1 m, 500,000 times Cable: Mandrel diameter: 100 mm, 5 kg load, 0.5 m, 500,000 times			
Compressive impact resistance	Columnar weight (25 mm dia., 2 lb), height: 1 m			

Note *The 2-C-2V-V cables have two optical fibers and power supply wires.

Transmission Characteristics

Item	Ambient temp.	Wavelength	Fiber length	Specification
Signal loss	25°C	λ=0.81 μm (DF-2700 LED) λ=0.85 μm (DF-2200 LED)	Lf=1 km	7 dB/km max.
			0.1 ≤ Lf ≤ 1 km	7-4 × log(Lf) dB/km max.
		λ=0.655 μm (DF-2701 LED)	Lf=1 km	15 dB/km max.
			0.1 ≤ Lf ≤ 1 km	15-4 × log(Lf) dB/km max.
Transmission band	---	λ=0.85 μm LED	Lf=1 km	Approx. 14 MHz
Signal loss at low temp.	-20°C	λ=0.81 μm	Lf=1 km	Up to two times the signal loss (in dB) at 25°C.
Signal loss at high temp.	25°C			Up to 1.5 times the initial signal loss (in dB) after 1,000 hrs at 70°C.
	-20°C (example)			Up to 1.5 times the initial signal loss (in dB) after 1,000 hrs at 70°C.
Signal loss at high temp. and humidity	25°C			Up to 1.5 times the initial signal loss (in dB) after 1,000 hrs at 70°C and 95%.

Crimp Connector Specifications

Item	Specification	Comments
Increase in signal loss (dB) due to crimp connection	Approx. 1.5 times higher with crimp connection.	λ=0.81 μm
Maximum tensile load	5 kgf	Unintentional temporary tension between the connector and cord at 25°C.
Signal loss (dB) at high temp.	±1.5 times the initial signal loss (in dB) after 1,000 hrs at 70°C.	Signal loss: The increase in signal loss (dB) compared to the initial value with λ=0.81 μm and T=25°C at both ends. Expansion: The change in the protrusion between the core and ferrule tip compared to the initial value.
Expansion at high temp.	±15 μm protrusion after 1,000 hrs at 70°C.	
Signal loss (dB) at high temp. and humidity	±1.5 times the initial signal loss (in dB) after 1,000 hrs at 70°C and 95%.	
Expansion at high temp. and humidity	±15 μm protrusion after 1,000 hrs at 70°C and 95%.	
Signal loss (dB) from 100 sudden temperature changes (70°C/-40°C)	±1.5 times the initial signal loss (in dB) after 1,000 hrs at 70°C and 95%.	
Expansion from 100 sudden temperature changes (70°C/-40°C)	±15 μm protrusion after 1,000 hrs at 70°C and 95%.	

Electrical Characteristics

Item	Specification
Cross sectional area of power supply wire's conductor	0.75 mm ²
Maximum conductor resistance	26.1 Ω/km (at 20°C)
Dielectric strength	1000 V for 1 minute
Minimum insulator resistance	5 MΩ km (at 20°C)
Maximum current	5 A/conductor

2-3 Factory Inspection

The items listed in the following table are checked at OMRON before shipping.

Item	Rating	Inspection method
Cladding diameter	Refer to the tables in 2-1 <i>Component Materials and Dimensions</i> .	Microscopic inspection of each production lot.
External cord diameter		Inspection of each production lot according to JIS.C.3005 section 5 guidelines.
Insulator thickness		
Jacket thickness		
External cable diameter		
Signal loss ($\lambda=0.81 \mu\text{m}$)	The 25°C ratings listed under the heading Transmission Characteristics in 2-2 <i>Specifications</i> .	Inspection of each production lot by the cutback method with $\lambda=0.81 \mu\text{m}$. (see note 1)
Max. conductor resistance	The ratings listed under the heading Electrical Characteristics in 2-2 <i>Specifications</i> .	JIS.C.3005 section 6 guidelines
Dielectric strength		JIS.C.3005 section 8(2) guidelines
Min. insulator resistance		JIS.C.3005 section 9.1 guidelines

- Note**
1. The results of the production lot inspections are used when lengths shorter than 0.1 km are shipped.
 2. The insulator thickness, max. conductor resistance, dielectric strength, and min. insulator resistance inspections are not performed on cables that do not have power supply wires.

SECTION 3

Connectors for H-PCF Optical Fibers

This section provides information on the dimensions, assembly, and testing of Optical Connectors used with H-PCF Optical Fiber Cords and Cables.

3-1	Connectors	14
3-2	Connector Components	16
3-3	Connector Assembly	17
3-4	Optical Power Testing	19
3-4-1	Optical Power Testers	19
3-4-2	Optical Power Testing Tools	19
3-4-3	Optical Power Testing Methods	20

3-1 Connectors

The following diagrams show the OMRON crimp connectors used with H-PCF Optical Fiber Cords and Cables. All dimensions are in millimeters.

S3200-COCH62M

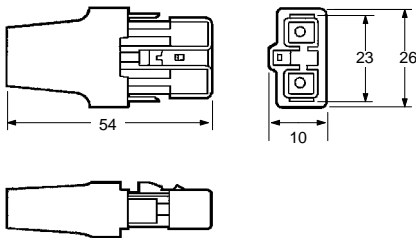

S3200-COCF62M

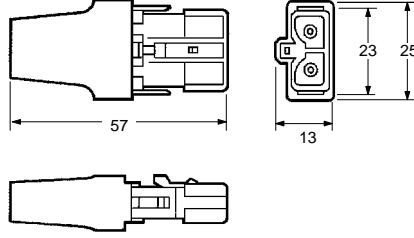

S3200-COCF62F

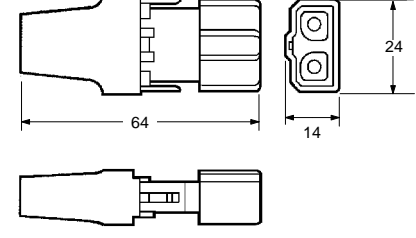

S3200-COCH82

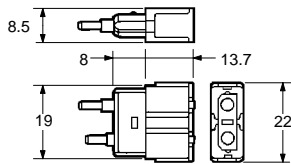

S3200-COCF2511

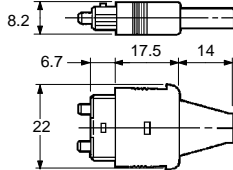

S3200-COCF2011

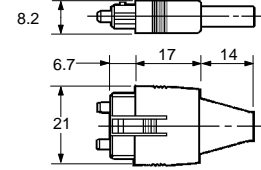

The following table lists the applications and applicable models for each of the OMRON crimp connectors shown above.

Model Number	Application	Applicable Models	Connection
S3200-COCH62M	SYSMAC NET Link nodes	S3200-LSU03-01E Line Server, C500-SNT31-V4 SYSMAC NET Link Unit, S3200-NSUG4-00E Bridge, S3200-NSUA1-00E NSU, S3200-NSB11-E NSB for IBM PC-ATs, FIT10-IF401 NSB for FITs	Full lock
S3200-COCF62M	SYSMAC NET Link repeaters	Used in pairs with the S3200-COCF62F	Full lock
S3200-COCF62F	SYSMAC NET Link repeaters	Used in pairs with the S3200-COCF62M	Full lock
S3200-COCH82	SYSMAC BUS and Host Link nodes	C500-RM001-(P)EV1, C120-RM001-(P)-E, C200H-RM001-PV1, C500-RT001-(P)EV1, C500-RT002-(P)EV1, C200H-RT001-P, C200H-RT002-P, C500-LK010-(P)-E, C120-LK010-(P)-E, 3G2C7-LK011-(P), 3G5A2-□□□-PE, C500-LK103-(P), C500-LK101-(P)EV1, C200H-LK101-P, 3G2A6-LK101-(P)EV1	Half lock
S3200-COCF2511	SYSMAC NET Link, SYSMAC LINK, and SYSMAC BUS/2 nodes	C200H-SNT31, CV500-SNT31, C200H-SLK11, C1000H-SLK11, CV500-SLK11, CV500-RM211, CV500-RT211	Half lock
S3200-COCF2011	SYSMAC NET Link, SYSMAC LINK, and SYSMAC BUS/2 nodes	CV500-SNT31, C1000H-SLK11, CV500-SLK11, CV500-RM211, CV500-RT211	Full lock
S3200-COIAT2000 Inline Adapter	SYSMAC NET Link, SYSMAC LINK, and SYSMAC BUS/2 repeaters	Inline Adapter	---

Maximum Transmission Distance

The maximum transmission distance between nodes connected with crimp connectors is 800 m. It is possible to produce low-signal-loss glued and polished connectors for predetermined optical fiber lengths or internode distances exceeding 800 m.

Applicable Connectors

The following table lists the Units that can use crimp connectors and their applicable connectors.

Model	Connector
S3200-LSU03-01E	S3200-COCH62M
S3200-NSUG4-00E	S3200-COCH62M
S3200-NSUA1-00E	S3200-COCH62M
S3200-NSB11-E	S3200-COCH62M
C500-SNT31-V4	S3200-COCH62M
C500-RM001-(P)EV1	S3200-COCH82
C500-RT001-(P)EV1	S3200-COCH82
C500-RT002-(P)EV1	S3200-COCH82
C500-LK010-(P)-E	S3200-COCH82
C500-LK103-(P)	S3200-COCH82
C500-LK101-(P)EV1	S3200-COCH82
C200H-RM001-PV1	S3200-COCH82
C200H-RT001-P	S3200-COCH82
C200H-RT002-P	S3200-COCH82
3G2C7-LK011-(P)	S3200-COCH82
C200H-LK101-P	S3200-COCH82
C200H-SNT31	S3200-COCF2511
C200H-SLK11	S3200-COCF2511
C120-RM001(-P)-E	S3200-COCH82
C120-LK010-(P)-E	S3200-COCH82
3G2A6-LK101-(P)EV1	S3200-COCH82
CV500-SNT31	S3200-COCF2511 S3200-COCF2011
CV500-SLK11	S3200-COCF2511 S3200-COCF2011
CV500-RM211	S3200-COCF2511 S3200-COCF2011
CV500-RT211	S3200-COCF2511 S3200-COCF2011
C1000H-SLK11	S3200-COCF2511 S3200-COCF2011
3G5A2-□□□-PE	S3200-COCH82
FIT10-IF401	S3200-COCH62M

3-2 Connector Components

The following diagrams show the construction of the OMRON crimp connectors used with H-PCF Optical Fiber Cords and Cables.

S3200-COCH62M

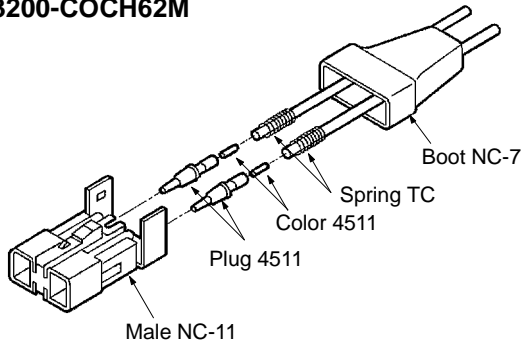

S3200-COCF62M

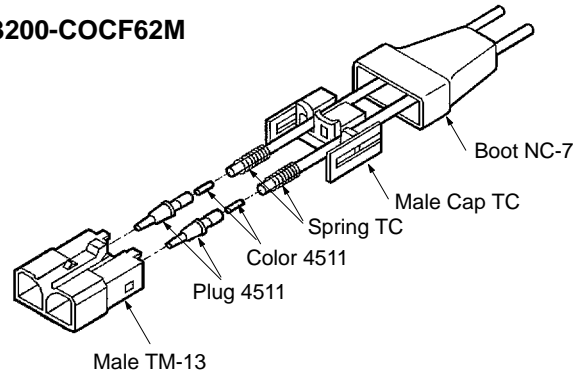

S3200-COCH62F

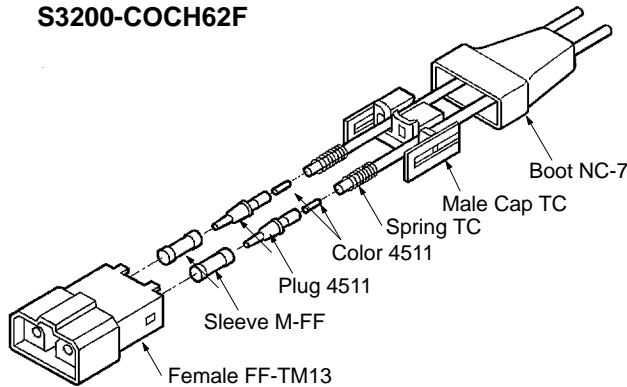

S3200-COCH82

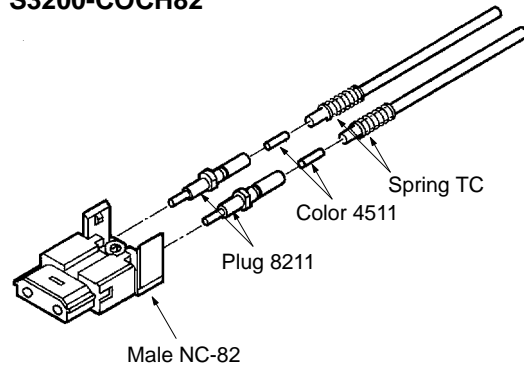

S3200-COCF2011

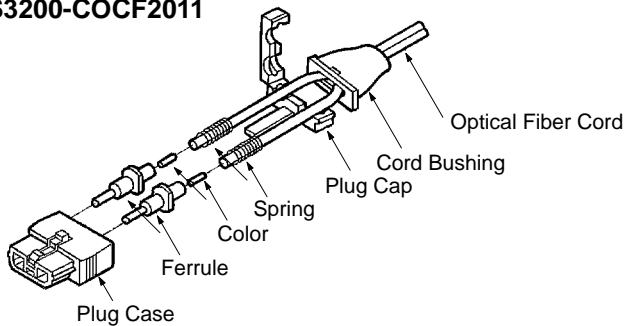

S3200-COIA2000

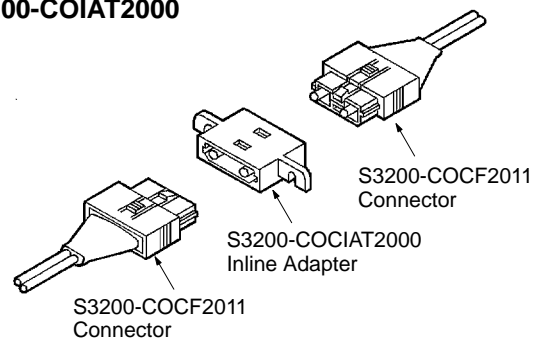

S3200-COCF2511

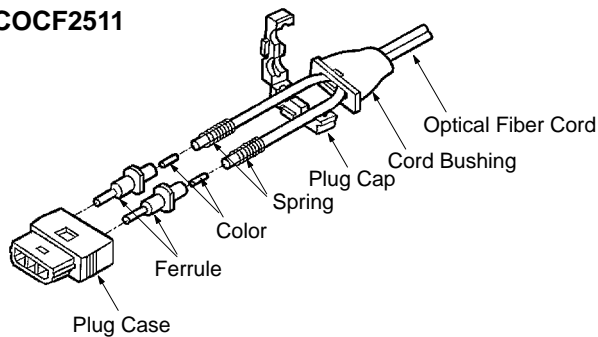

3-3 Connector Assembly

The specialized connector assembly tools needed to attach connectors to the H-PCF Optical Fiber Cord or Cable on site must be purchased separately. All of the required tools are included in the Optical Connector Assembly Tool Kit in a compact carrying case. Refer to *Appendix A Standard Models* for ordering information.

In the past, attaching connectors to the optical fiber required time-consuming gluing and polishing, but crimp connectors can be attached quickly and easily using a ferrule crimper and optical fiber cutter. Refer to *3-4 Optical Power Testing* for details on testing light transmission through the connector/fiber junction with an Optical Power Tester.

Optical Connector Assembly Tool Kit

The Optical Connector Assembly Tool Kit includes all of the tools required to attach the six optical connectors described in 3-1 *Connectors*. The following diagram shows the Optical Connector Assembly Tool Kit and the following table identifies the tools.

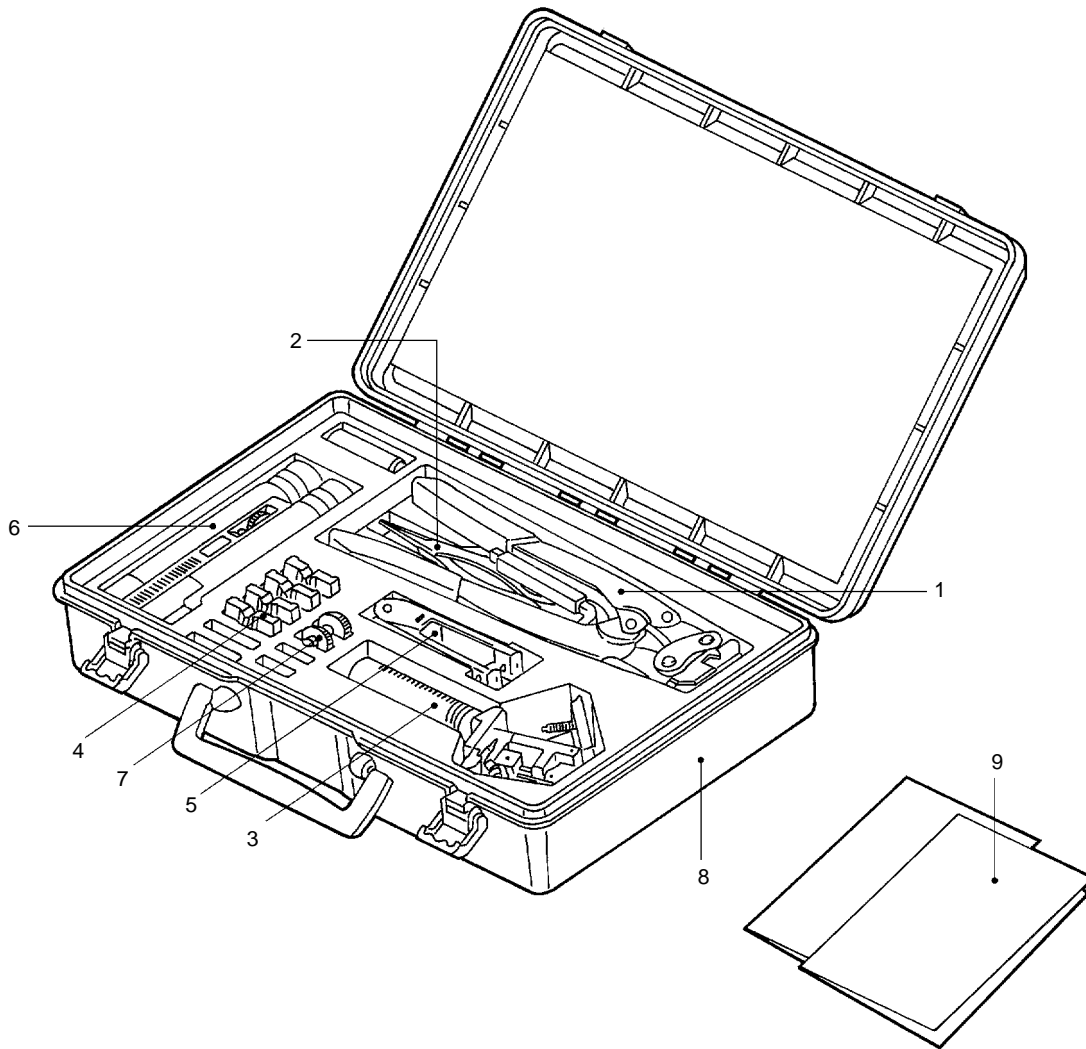

Number	Tool Name	Model Number	Quantity
1	Ferrule Crimper	FK-22	1
2	Scissors	---	1
3	Optical Fiber Cutter	FC-200	1
4	Optical Fiber Cutter Adapters	7155	1
		4511	1
		8211	1
		FCST	1
5	Jacket Remover	JR-2205	1
6	Magnifier (with battery)	CAT-100X	1
7	Magnifier Adapters	180-FC	1
		180-S	1
8	Carrying Case	---	1
9	Instruction Booklets	Sankougishi 1006 (English)	1

3-4 Optical Power Testing

3-4-1 Optical Power Testers

The Optical Power Testers and applicable units/boards are listed in the following table. One of the Master Fiber Sets listed in the next table is needed to test light output with an Optical Power Tester Set.

Power Tester Set	Head Unit	Applicable Unit/Board	Applicable Optical Connector
S3200-CAT3200	S3200-CAT3202	C500-SNT31-V4, SYSMAC NET Link nodes	S3200-COCH62M, S3200-COCF62M, S3200-COCH62F
S3200-CAT2000	S3200-CAT2002	C200H-SNT31, CV500-SNT31, SYSMAC NET Link nodes	S3200-COCF2511, S3200-COCF2011
S3200-CAT2700	S3200-CAT2702	C200H-SLK11, C1000H-SLK11, CV500-SLK11, CV500-RM211, CV500-RT211	S3200-COCF2511, S3200-COCF2011
S3200-CAT2820	S3200-CAT2822	C500-RM001-(P)EV1, and other C-series Host Link, Optical Remote I/O, and I/O Link Units	S3200-COCH82

- Note**
1. All parts in the Power Tester Sets are compatible except the Head Units.
 2. Refer to the table on page 15 for a complete list of units, boards, and their applicable Optical Connectors.

Master Fiber Sets

A Master Fiber Set is needed when testing light output with an Optical Power Tester Set. The required Master Fiber Set depends on the Head Unit, as shown in the following table.

Head Unit Set	Master Fiber Set
S3200-CAT3202	S3200-CAT3201
S3200-CAT2002	S3200-CAT2001H
S3200-CAT2702	
S3200-CAT2822	S3200-CAT2821

Refer to the Master Fiber Set’s instruction booklet for details on using the Master Fiber Set.

3-4-2 Optical Power Testing Tools

Use the S3200-CAT2000 or S3200-CAT2700 Optical Power Tester Set to test light transmission through the connector/fiber junction.

Optical Power Tester Set and Head Unit Set

The following tables provide information on the Optical Power Tester Sets and Head Unit Sets.

Optical Power Tester Set	Head Unit Set	Wave-length	Applicable Optical Module	Applicable Optical Connectors
S3200-CAT2000	S3200-CAT2002	850 nm	DF-1100 DF-2100 DF-2200	CF-2001H, S3200-COCF2011 CF-2501H, S3200-COCF2511
S3200-CAT2700	S3200-CAT2702	810 nm	DF-1700, TODX294 (OMRON) DF-1800 DF-2700 DF-2800	CF-2001H, S3200-COCF2011 CF-2501H, S3200-COCF2511

The following table lists the component parts of the Optical Power Tester Sets and Head Unit Sets.

Component	Optical Power Tester Set		Head Unit Set	
	S3200-CAT2000	S3200-CAT2700	S3200-CAT2002	S3200-CAT2702
Main Unit	Model 205	Model 205	---	---
Connector Adapter	180-HTL	180-HTL	180-HTL	180-HTL
Light Source	310-085CF (yellow label)	310-081CF (orange label)	310-085CF (yellow label)	310-081CF (orange label)
AC Adapter	DP-1005	DP-1005	---	---
Instruction Booklets	Higishi 1939 (English)	Higishi 1939 (English)	Higishi 1939 (English)	Higishi 1939 (English)

The following diagrams show the Power Tester Main Unit, the Connector Adapter (transmitter and receiver), and the Light Source.

Power Tester Main Unit

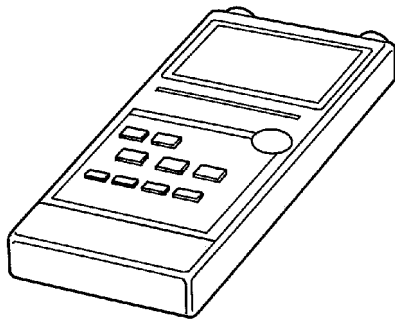

Connector Adapter

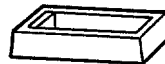

Light Source

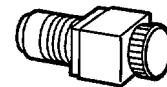

Master Fiber Set

The S3200-CAT2001H Master Fiber Set contains standard optical fibers that are used in conjunction with the Optical Power Tester Sets when measuring optical characteristics. Components of the S3200-CAT2001H Master Fiber Set are listed in the following table.

Component	Model Number	Quantity
2001-MM-1 Master Fiber (see note)	DCV-HC-20/07	1 m × 2
Inline Adapter	IAT-2000	1
Case	---	1

Note These optical fibers are sorted for use as master fibers.

3-4-3 Optical Power Testing Methods

The light transmitted through a cable with optical connectors or inline adapters should satisfy the ratings given later in this section. The ratings use the value a_f , which can be calculated from the length of the optical fiber (L), as shown in the following table.

Total Fiber Length (L)	a_f
0.1 km < L ≤ 1 km	$(7-4 \times \log L) \times L$
L ≤ 0.1 km	1.1

Testing Optical Fibers with Two Crimp Connectors

The amount of light transmitted through an optical fiber with crimp connectors at both ends should satisfy the ratings given in the following table. The maximum transmission distance for this configuration is 800 m.



Light Path	Rating
OPT LED (see note 1) → Master Fiber → Light Meter (measuring P_0 dBm)	---
OPT LED → Test Fiber (see note 2) → Light Meter (measuring P_1 dBm)	$P_0 - P_1 \leq af + 1.5$ dB
OPT LED → Test Fiber → Inline Adapter (see note 3) → Master Fiber → Light Meter (measuring P_2 dBm) (see note 4)	$P_0 - P_2 \leq af + 3.5$ dB

- Note**
1. The term OPT LED refers to an Optical Power Tester LED light source.
 2. The term Test Fiber refers to an optical fiber with crimp connectors (S3200-COCF2011 and/or S3200-COCF2511) on both ends.
 3. An S3200-COIAT2000 Inline Adapter.
 4. It is not necessary to measure P_2 when an Inline Adapter is not used.

Testing Optical Fibers Linked by an Inline Adapter

The amount of light transmitted through two optical fibers attached by an Inline Adapter should satisfy the ratings given in the following table. Each optical fiber has a crimp connector on just one end and this end is attached to the Inline Adapter. The maximum transmission distance for this configuration is 200 m.

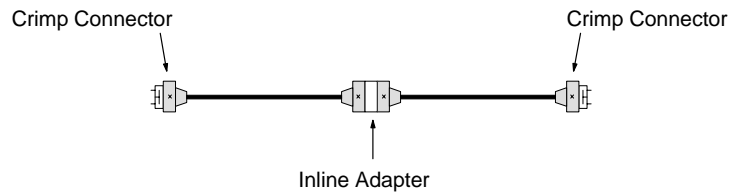

Light Path	Rating
OPT LED (see note 1) → Master Fiber → Light Meter (measuring P_0 dBm)	---
OPT LED → Test Fiber (see note 2) → Inline Adapter (see note 3) → Test Fiber → Light Meter (measuring P_1 dBm)	$P_0 - P_1 \leq af + 7.1$ dB

- Note**
1. The term OPT LED refers to an Optical Power Tester LED light source.
 2. The term Test Fiber refers to an optical fiber with a crimp connector (S3200-COCF2011 or S3200-COCF2511) on the end connected to the Inline Adapter.
 3. An S3200-COIAT2000 Inline Adapter.

SECTION 4

H-PCF Cord and Cable Installation

This section describes how to install H-PCF Optical Fiber Cords and Cables in buildings and around equipment at building sites.

- 4-1 Introduction 24
- 4-2 Installation Conditions 24
- 4-3 Basic Installation Methods 24
 - 4-3-1 Preparing a Cord for Pulling 24
 - 4-3-2 Preparing a Cable for Pulling 26
 - 4-3-3 Cord or Cable Installation 27
- 4-4 Installation Precautions 29
 - 4-4-1 Rack or Trough Installation 29
 - 4-4-2 Installation in Electrical Conduit 30
 - 4-4-3 Installation in Ducts 32
 - 4-4-4 Elevated Installation 32
- 4-5 Securing the Cord or Cable 33
- 4-6 Increasing Cable Length 34
- 4-7 Connector Attachment 34

4-1 Introduction

Although Optical Fiber Cable is similar in appearance to ordinary coaxial cable or power supply wiring, it is more fragile and must be handled with proper care. The following table shows the basic mechanical limitations of Optical Fiber Cords and Cables.

Item	Tensile Load	Bend Radius	Lateral Pressure	Twist
Optical Fiber Cord	10 kg max. when laying cord 0 kg when installed	60 mm max. when laying cord 30 mm max. when installed	30 kg/10 cm max.	180°/2 m max.
Optical Fiber Cable	50 kg max. when laying cable 5 kg max. when installed	200 mm max. when laying cable 100 mm max. when installed	50 kg/10 cm max.	90°/2 m max.

This manual does not provide information regarding oil and chemical resistance of cords and cables or specifications for special applications in which the cord or cable is subjected to bending motions. Consult your OMRON dealer for details on these specifications.

Caution An Optical Fiber Cable or Cord's transmission characteristics will deteriorate if it is stretched beyond 0.2%. Be sure to pull the Optical Fiber Cable or Cord by the tension member and observe the tensile load limits listed in the specifications. Do not allow the cable or cord to be stretched by a falling load, or bent or twisted to an extreme angle.

4-2 Installation Conditions

The following table provides information for installing Optical Fiber Cord or Cable in a variety of conditions.

Installation	Optical Fiber Cord	Optical Fiber Cable
Hanging Rack	Provide adequate protection.	Protect the cable when there are external forces that might damage the cable.
Trough	Use a cover, etc., to provide adequate protection.	Protect the cable when there are external forces that might damage the cable.
Electrical Conduit	Use steel electrical conduit, PVC pipe, or plastic duct.	Use steel electrical conduit, PVC pipe, or plastic duct.
Outdoor Conduit	A connector-less cord can be laid in an outdoor conduit if locations subject to flooding or high temperature are avoided. (see note 1)	Be sure to avoid locations subject to flooding or high temperature. (see note 1)
Elevated Wiring	Not recommended.	Be sure to prevent excessive tensile vibrations.
Buried Wiring	Not recommended.	Not recommended. (see note 2)

- Note**
1. The outer sheath of cords and cables is PVC. Consult your OMRON dealer if the installation site has oils or chemicals that can damage PVC. Also consult your dealer if the cable will be subject to movement.
 2. It is possible to bury a cable if special construction is used. Consult your OMRON dealer for details.

4-3 Basic Installation Methods

4-3-1 Preparing a Cord for Pulling

Optical Fiber Cords must not be pulled by their optical fibers, but by the cord's reinforcement material. This section describes three methods for preparing a

loop at the end of an Optical Fiber Cord. These methods will not make the end of the cord watertight. If the cord is being pulled through water, be sure to treat the end of the cord so it is watertight.

Example 1

The following diagram and list describe the basic procedure for preparing an Optical Fiber Cord for pulling.

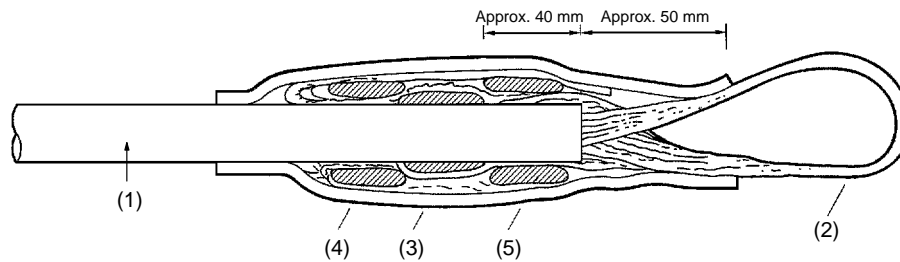

- 1, 2, 3...**
1. First remove about 300 mm of the outer PVC sheath from the end of the Optical Fiber Cord (1).
 2. Wrap about 1 mm of adhesive PVC tape (3) about 40 mm from the end of the PVC sheath.
 3. Create a loop by folding back the internal reinforcement material (2) about 50 mm from the end of the PVC sheath and secure it to the cord by wrapping PVC tape around it (4).
 4. Wrap another layer of tape around the reinforcement material close to the end of the PVC sheath (5).
 5. Finally, wrap the end of the cord from the exposed PVC sheath to close the the loop made from the reinforcement material. This last layer of PVC tape will protect the end of the cord but won't make it watertight.
 6. When laying the cord, connect a lead wire to the loop of reinforcement material and pull the cord.

Example 2

In order to increase the tensile force that can be applied when laying the cord, a loop knot can be tied in the reinforcement material. The end of the cord should then be covered from the PVC sheath past the loop knot. This treatment will not make the end of the cord watertight.

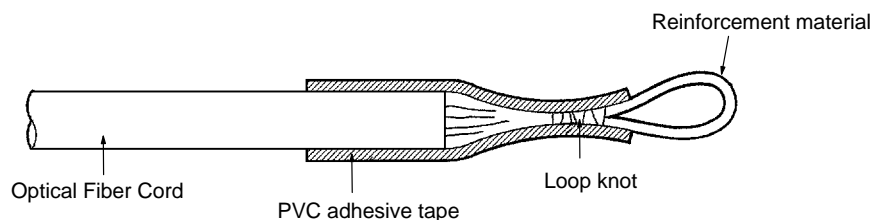

The loop knot shown in the following diagram, known as a guide knot, is a good knot to use to tie the reinforcement material. It is the simplest knot used by moun-

tain climbers when the rope is tied around the body and can be mastered quickly by beginners.

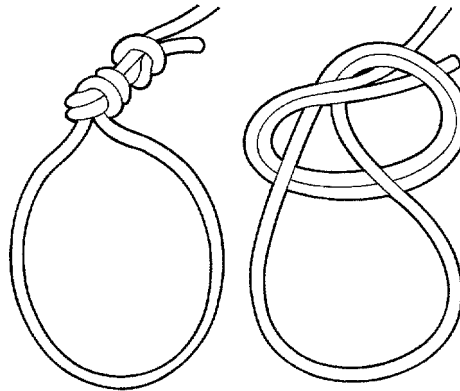

Example 3

If the cord is being pulled through a relatively large conduit, a cord can be folded back onto itself and taped to make a loop. If this method is used, the end of the cord which was folded will be damaged and cannot be used to transmit light. Cut off the end of the cord after it has been installed.

4-3-2 Preparing a Cable for Pulling

Optical Fiber Cables must not be pulled by their optical fibers or power wires, but by the cable’s tension member. The methods described here will not make the end of the cable watertight. If the cord is being pulled through water, be sure to treat the end of the cable so it is watertight.

Cable Without a Connector

Follow the procedure below to prepare an Optical Fiber Cable without a connector attached.

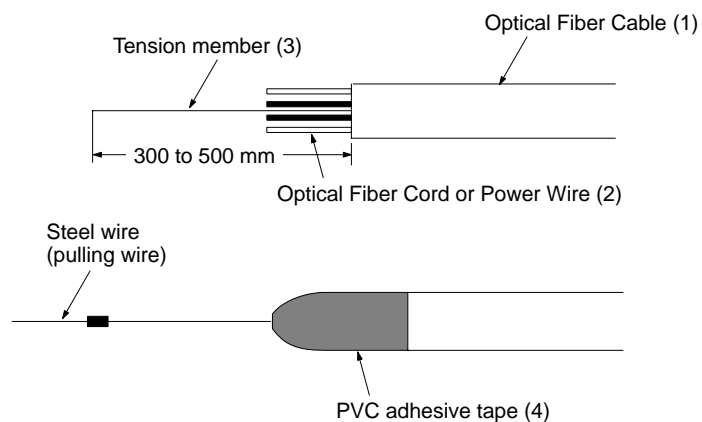

- 1, 2, 3...**
1. First remove 300 to 500 mm of the outer PVC sheath from the end of the Optical Fiber Cable (1).
 2. Cut the Optical Fiber Cords, power wires, and spacing cords so that the tension member (3) protrudes.
 3. Cover the Optical Fiber Cords and power wires with a protective tube or cover and wrap the end of the cable with PVC tape.
 4. Tie the exposed tension member to the steel pulling wire.

Cable With a Connector

Follow the procedure below to prepare an Optical Fiber Cable with a connector attached.

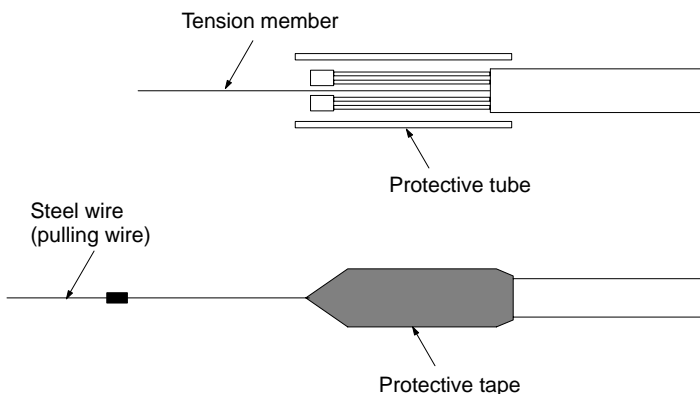

- 1, 2, 3...**
1. First remove any parts of the connector’s plastic housing that can be removed.
 2. Cover the Optical Fiber Cords and power wires with a protective tube or cover and wrap the end of the cable with PVC tape.
 3. Tie the exposed tension member to the steel pulling wire.

4-3-3 Cord or Cable Installation

This section describes three methods for pulling cable through conduit. When pulling the cord or cable from the reel, raise it off of the ground with a reel jack so that it can turn easily. Pull the cable off of the reel while spinning the reel so that only moderate force is placed on the cable itself.

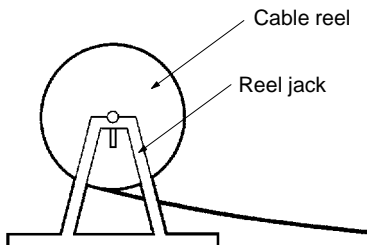

When removing cable from the reel, apply less than 2/3 of the maximum tensile load for the cable and unreel the cable at less than 10 m/min.

One-way Pulling

With this method, the cord or cable is pulled or laid in one direction. Pull the cable from the higher to the lower end of the route if one end is higher than the other and pull from the end closest to the turn if there is a turn or bend in the route.

Station people along the route to monitor the installation or pull the cable to avoid excessive force (pulling tension, compression, bending, or twisting) on the cable. Insert a tension meter to monitor pulling tension if the tension is suspected to be too great.

Midpoint puller
(Station a puller along the pulling route if the tension is too high.)

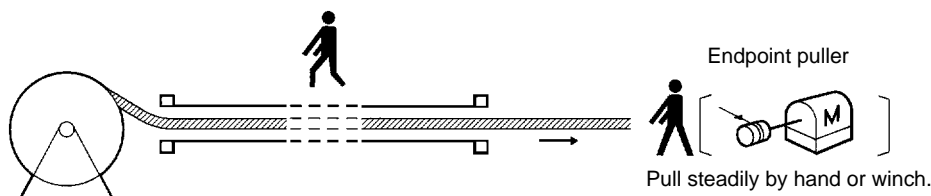

Multiple-stage Pulling

With this method the cable is installed in one direction, but the cable is pulled through the route in stages. The remainder of the cable is temporarily piled in figure-eight layers at the end of each successive stage. A single stage might be selected because it is a practical pulling distance or because it ends at a turn in the route.

In the following example, a cable is laid in two stages which are separated by a 90° turn.

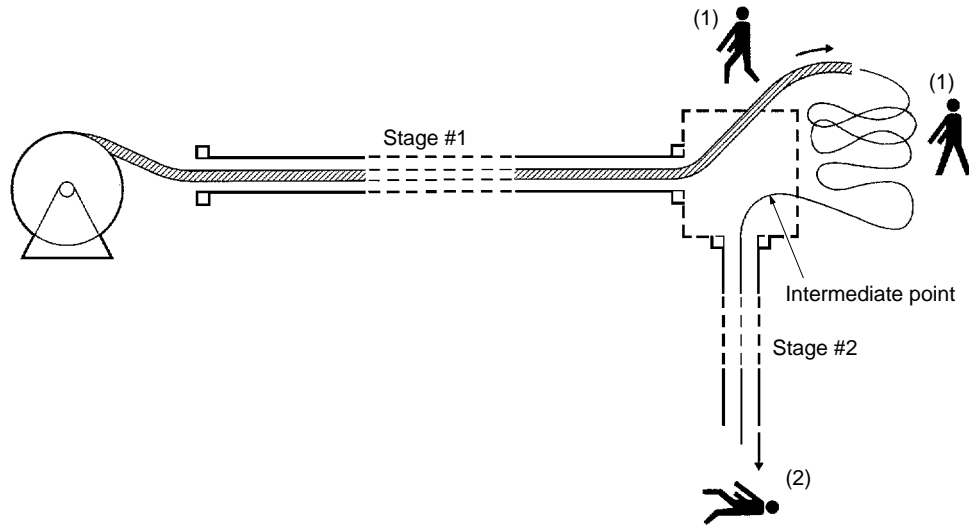

- 1, 2, 3...**
1. Pull or lay all of the required cable through stage #1 and pile the remaining cable in figure-eight layers at the turn in the installation route.
 2. Pull or lay the second stage of the installation route from the turn, taking care not to tangle or twist the cable.
 3. Repeat steps 1 and 2 for installation routes with 3 or more stages.

Two-way Pulling

If it is impossible to install the cable in one direction because of restricted access or sharp turns along the route, pull the cable in two directions from an intermediate point on the route.

Install the cable in one direction, remove the remaining cable from the reel and pile it in figure-eight layers, and install that part of the cable in the opposite direction.

Be sure to follow the precautions described above under the heading “one-way pulling” and eliminate any bends or twists in the cable after installation.

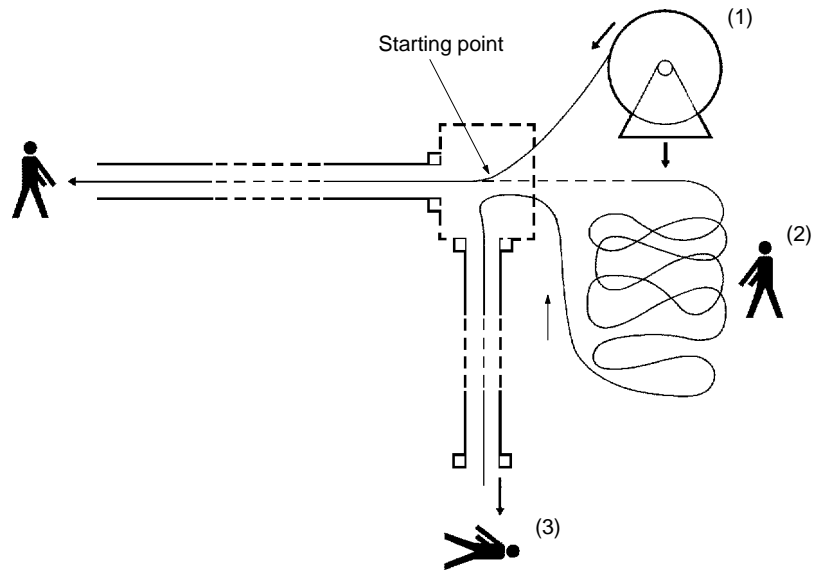

- 1, 2, 3...**
1. Pull or lay the cable from the starting point in the first direction (1).
 2. Remove the remaining cable from the reel and pile it in figure-eight layers near the starting point (2).
 3. Install the remaining cable in the second part of the installation route, taking care not to tangle or twist the cable (3).

4-4 Installation Precautions

4-4-1 Rack or Trough Installation

Install the cord or cable on the rack (or in the trough) being careful not to apply too much tension, bending, or twisting, and allowing a little slack (about 10 mm/m).

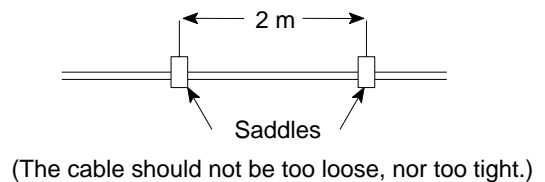
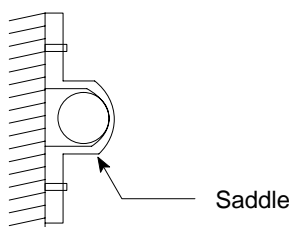

Do not install the cord or cable on top of or between power supply wires. The power wires might cut into the cord or cable or pinch it, increasing the pulling tension. Allow at least 10 mm between the Optical Fiber Cord or Cable and power supply wires or install the Optical Fiber Cord or Cable off to the side, as shown below.

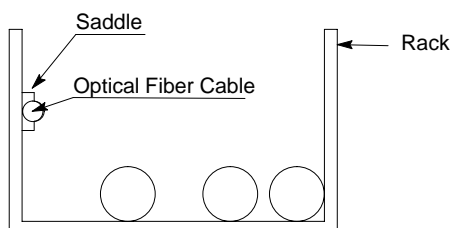

Note Be sure to protect the connector on Optical Fiber Cords or Cables that have connectors attached. In particular, use a protective cap to prevent the tip of the connector from being contaminated by dirt.

4-4-2 Installation in Electrical Conduit

Use a steel conduit, high or low-relief PVC pipe, or flexible plastic pipe. Use a conduit with a diameter taken from the following table.

Connector Attachment	Outer Diameter	Inner Diameter	Electrical Conduit		Application
			Thick wall	Thin wall	
Connector attached on site	19 to 21 mm	16 mm	16	19	Optical Fiber Cord only
	25 to 27 mm	22 mm	22	25	Optical Fiber Cord or Cable
Connector already attached	25 to 27 mm	22 mm	22	25	Optical Fiber Cord only
	32 to 33 mm	28 mm	28	31	Optical Fiber Cord or Cable

The inside of the conduit should be smooth, without any projections or joints that might impede the cord or cable. Install just one Optical Fiber Cord or Cable in a conduit.

The length of the conduit should be no more than 25 meters when the conduit is straight and level. When the conduit has bends along its path, the overall length should be approximately 20 meters or less. When the route is vertical, pull boxes (about 200 × 300 × 700 mm) should be installed at intervals of approximately eight meters.

In the following diagram P.B. indicates a pull box.

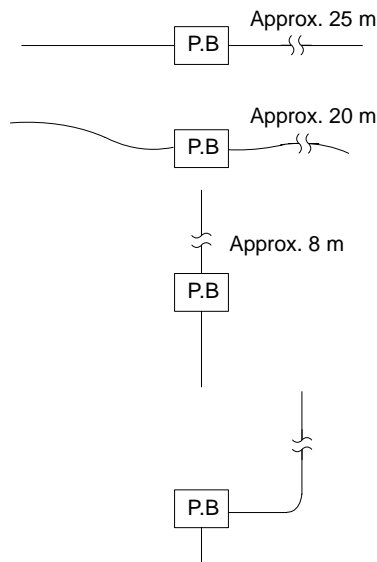

Use a pre-bent piece of pipe or bend the conduit with a pipe bending tool. The radius of the bend should be at least six times larger than the internal

diameter of the conduit. Attach a bushing and saddles at the end of the conduit so that the Optical Fiber Cable does not bend at too sharp an angle.

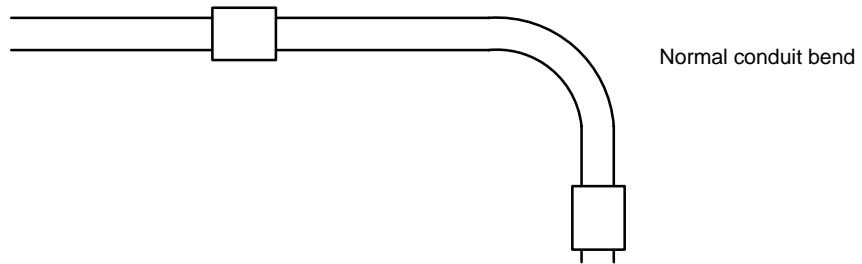

Turns in the installation route should be avoided if possible, but if a turn must be made, pull boxes are preferred to bends in the conduit. The pull boxes should be large enough to allow the Optical Fiber Cord or Cable to bend with a large enough radius, and the connecting conduit should be straight.

The Optical Fiber Cord or Cable can be installed by the “multiple-stage pulling” or “two-way pulling” methods described in 4-3-3 Cord or Cable Installation. Three stages would be required for the route shown in the following diagram.

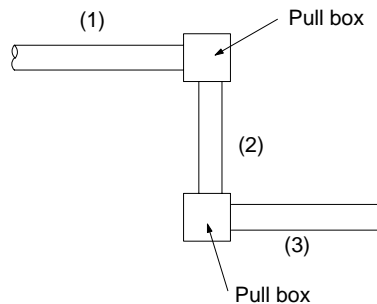

Use the pull boxes as intermediate points when installing the cable. Pull the cable through the first pull box and set aside the remainder in figure-eight layers as described in 4-3-3 Cord or Cable Installation. Repeat this process for each pull box, being careful not to pull, bend, or twist the cable excessively.

The pull box must be large enough to allow room for the minimum bend radius shown in the following table plus some room for expansion.

Item	Bend Radius at Installation	Bend Radius after Installation
Optical Fiber Cord	Greater than 60 mm	Greater than 30 mm
Optical Fiber Cable	Greater than 200 mm	Greater than 100 mm

Insert bushings at the entrance and exit of the pull box and guides to prevent sharp bends in the cable. The cable should be held in place and not move freely.

If the area where the turn must be made is inaccessible (when the electrical conduit bends), two bends can be made very carefully in the conduit. The installation will be limited by the radius of the bends (R), angle of the

bends (θ), number of bends, diameter of the conduit, and total distance of the route.

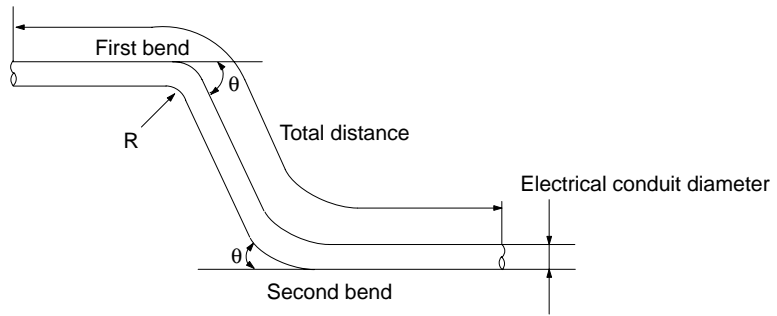

Insert bushings at the ends of the conduit and install guides to prevent sharp bends.

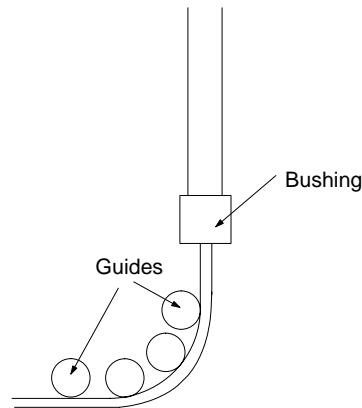

4-4-3 Installation in Ducts

The instructions for installation in electrical conduits also apply to installation in ducts. Flooding might occur in outdoor underground installation sites, so be sure to waterproof the end of the Optical Fiber Cord or Cable with a waterproofing compound or adhesive tape before pulling it through the duct.

4-4-4 Elevated Installation

Optical Fiber Cables can be hung from a support cable like ordinary low-tension power lines. It is not recommended to hang Optical Fiber Cords, especially outdoors.

Support the Optical Fiber Cable from a sufficiently thick support cable (greater than the earlier 22 mm² metal cable) using suitable hooks spaced at intervals of 50 mm max.

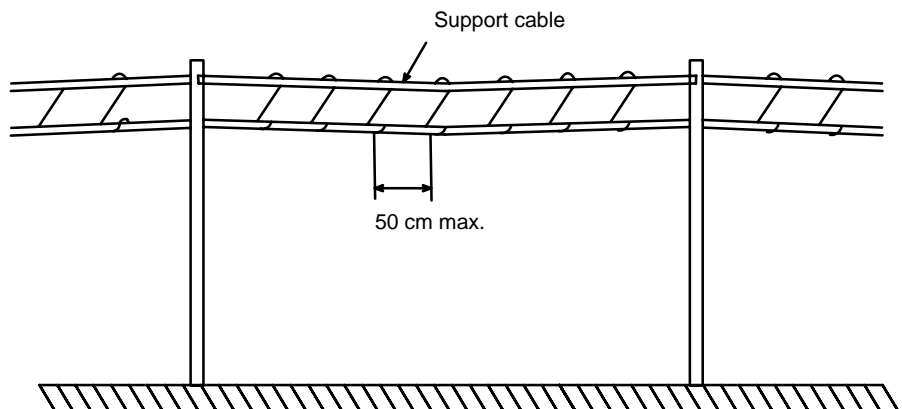

Gently unreel the Optical Fiber Cable at less than 10 m/min by spinning the reel, so that no pulling tension is applied to the Optical Fiber Cable itself. Be sure not to apply any force to the cable (tension, bending, compression, twisting, or impact) during installation that exceeds its maximum specifications.

The minimum bend radius for an Optical Fiber Cable during installation is 200 mm (20 times the cable diameter). Use a tool such as a pulley at bends of the cable to ensure that the bends exceed the minimum radius.

When installing straight sections, use pulleys as guides to ensure that the tension on the cable does not exceed the maximum value. Set the pulleys no more than 25 meters apart and allow the cable to sag at least 0.5 m.

Use a tension meter to monitor the tension in the cable if it is suspected to be too high, and pull the cable along the installation route by hand or other means if the tension is found to be too high.

Note It is good practice to leave about 2 or 3 meters of spare cable before each node connection. This margin of cable allows room for attaching the connector and some repositioning of the node.

4-5 Securing the Cord or Cable

After laying the Optical Fiber Cord or Cable along the installation route, remove the tape or tube used to protect the end of the cable. If a ferrule is going to be attached to the end of the cable, clean the end of the ferrule surface with water and wipe it with a soft, clean, and lint-free cloth or paper towel.

Optical Fiber Cord

When installed in a rack or trough, secure the cord gently with mounting brackets or saddles to prevent movement. Be sure not to attach the brackets or saddles too tightly, because excessive compression will damage the cord.

At the last mounting bracket, bushing, or saddle, protect the cord with a rubber ring, strip of rubber, or a few layers of PVC tape and secure it. Leave enough slack in the cord to attach and remove the connector or move the node, if necessary.

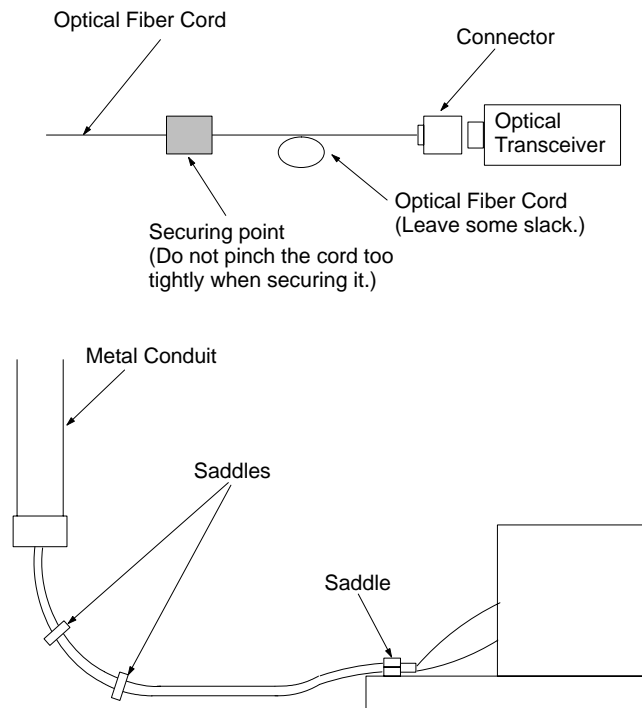

Optical Fiber Cable

When installed in a rack or trough, secure the cable with mounting brackets or saddles to prevent movement. Be sure not to attach the brackets or saddles too tightly, because excessive compression will damage the cable.

Use a bushing with a rubber ring, saddle, etc., to secure the cable to the wall of the housing or panel where the cable ends. If the bushing or saddle is too large for the cable, wrap a strip of rubber or a few layers of PVC tape so it fits snugly. Leave 2 to 3 m of slack in the cable if connectors are being attached on site.

Take up any slack from the tension member and fasten it securely. The tension member's metal fastener must be properly grounded. Always secure the tension member.

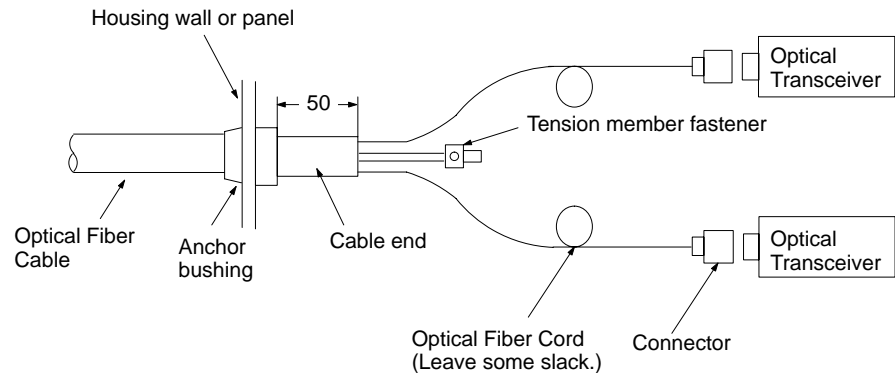

- Note**
1. Protect the end of the cable with conduit if the exposed cable is in a location where it might be stepped on or damaged accidentally.
 2. If conduit is used, insert a bushing at the end of the conduit and use saddles or guides to prevent the cable from being bent at too severe an angle.

4-6 Increasing Cable Length

In general, an Optical Fiber Cord or Cable that is not long enough should be replaced with a cord or cable of sufficient length.

When a cord or cable is installed in a trough or rack, the connection point is indoors and accessible, and an increase in signal loss of 1.5 dB is acceptable, an extension cable can be connected with an inline adapter. Transmissions with two cables connected by an inline adapter are less reliable than transmissions through a single cable.

Use of an inline adapter in conduit, duct, or elevated installation should be avoided because of reliability concerns.

4-7 Connector Attachment

Refer to the manual included with the S3200-CAK1062 Optical Connector Assembly Tool Kit for information regarding the attachment of connectors to Optical Fiber Cords and Cables.

Appendix A Standard Models

H-PCF Two-fiber Optical Fiber Cord

Connectors	Tension Member	Power Wires	Color	Length	Model number	Applications
No	No	No	Black	10 m	S3200-HBCB101	SYSMAC NET Link, SYSMAC LINK, SYSMAC BUS/2, SYSMAC BUS, SYSMAC Host Link
				50 m	S3200-HBCB501	
				100 m	S3200-HBCB102	
				500 m	S3200-HBCB502	
				1,000 m	S3200-HBCB103	

H-PCF Two-fiber Optical Fiber Cable (Without Connectors)

Connectors	Tension Member	Power Wires	Color	Length	Model Number	Applications	
No	Yes	Yes	Black	10 m	S3200-HCLB101	SYSMAC NET Link	
				50 m	S3200-HCLB501		
				100 m	S3200-HCLB102		
				500 m	S3200-HCLB502		
				1,000 m	S3200-HCLB103		
			Orange	10 m	S3200-HCLO101		
				50 m	S3200-HCLO501		
				100 m	S3200-HCLO102		
				500 m	S3200-HCLO502		
				1,000 m	S3200-HCLO103		
	No	No	No	Black	10 m	S3200-HCCB101	SYSMAC NET Link, SYSMAC LINK, SYSMAC BUS/2, SYSMAC BUS, SYSMAC Host Link
					50 m	S3200-HCCB501	
					100 m	S3200-HCCB102	
					500 m	S3200-HCCB502	
					1,000 m	S3200-HCCB103	
				Orange	10 m	S3200-HCCO101	
					50 m	S3200-HCCO501	
					100 m	S3200-HCCO102	
					500 m	S3200-HCCO502	
					1,000 m	S3200-HCCO103	
No	No	No	Black	10 m	S3200-HCCB101N	SYSMAC NET Link, SYSMAC LINK, SYSMAC BUS/2, SYSMAC BUS, SYSMAC Host Link	
				50 m	S3200-HCCB501N		
				100 m	S3200-HCCB102N		
				500 m	S3200-HCCB502N		

Note We will continue to accept orders for conventional cable models S3200-FH-L-C22T and B500-OF□□□.

H-PCF Two-fiber Optical Fiber Cable (With Connectors)

Tension Member	Power Wires	Color	Connectors	Length	Model Number	Applications
Yes	Yes	Black	Both S3200-COCF2011	2 m	S3200-CN201-20-20	SYSMAC NET Link SYSMAC LINK SYSMAC BUS/2
				5 m	S3200-CN501-20-20	
				10 m	S3200-CN102-20-20	
				15 m	S3200-CN152-20-20	
				20 m	S3200-CN202-20-20	
			One S3200-COCF2011, one S3200-COCF2511	2 m	S3200-CN201-20-25	
				5 m	S3200-CN501-20-25	
				10 m	S3200-CN102-20-25	
				15 m	S3200-CN152-20-25	
				20 m	S3200-CN202-20-25	
			One S3200-COCF2011, one S3200-COCH62M	2 m	S3200-CN201-20-62	
				5 m	S3200-CN501-20-62	
				10 m	S3200-CN102-20-62	
				15 m	S3200-CN152-20-62	
				20 m	S3200-CN202-20-62	
			Both S3200-COCF2511	2 m	S3200-CN201-25-25	
				5 m	S3200-CN501-25-25	
				10 m	S3200-CN102-25-25	
				15 m	S3200-CN152-25-25	
				20 m	S3200-CN202-25-25	
			One S3200-COCF2511, one S3200-COCH62M	2 m	S3200-CN201-25-62	
				5 m	S3200-CN501-25-62	
				10 m	S3200-CN102-25-62	
				15 m	S3200-CN152-25-62	
				20 m	S3200-CN202-25-62	
			Both S3200-COCH62M	2 m	S3200-CN201-62-62	SYSMAC NET Link
				5 m	S3200-CN501-62-62	
				10 m	S3200-CN102-62-62	
				15 m	S3200-CN152-62-62	
				20 m	S3200-CN202-62-62	

Note We will continue to accept orders for conventional cable models S3200-FH-L-C22T and B500-OF□□□.

Optical Connectors

Model Number	Connection	Applicable Units/Boards
S3200-COCH62M	Full lock	SYSMAC NET Link: S3200-LSU03-01E, C500-SNT31-V4, S3200-NSUG4-00E, S3200-NSUA1-00E, S3200-NSB11-E, FIT10-IF401
S3200-COCF62M	Relay (male)	Used with the S3200-COCF62F.
S3200-COCF62F	Relay (female)	Used with the S3200-COCF62M.
S3200-COCH82	Half lock	SYSMAC BUS: C500-RM001-(P)EV1, C120-RM001(-P)-E, C200H-RM001-PV1, C500-RT001-(P)EV1, C500-RT002-(P)EV1, C200H-RT001-P, C200H-RT002-P, C500-LK010(-P)-E, C120-LK010(-P)-E, 3G2C7-LK011(-P), 3G5A2-□□□-PE SYSMAC Host Link: C500-LK103(-P), C500-LK101-(P)EV1, C200H-LK101-P, 3G2A6-LK101-(P)EV1
S3200-COCF2511	Half lock	SYSMAC NET Link: C200H-SNT31, CV500-SNT31 SYSMAC LINK: C200H-SLK11, C1000H-SLK11, CV500-SLK11 SYSMAC BUS/2: CV500-RM211, CV500-RT211
S3200-COCF2011	Full lock	SYSMAC NET Link: CV500-SNT31 SYSMAC LINK: C1000H-SLK11, CV500-SLK11 SYSMAC BUS/2: CV500-RM211, CV500-RT211
S3200-COIAT2000	Relay	Inline Adapter used with the S3200-COCF2511 and S3200-COCF2011.

Optical Connector Assembly Tool Set

Model Number	Applicable connectors
S3200-CAK1062	S3200-COCH62M, S3200-COCF62M, S3200-COCF62F, S3200-COCF2511, S3200-COCF2011, S3200-COCH82

Note The S3200-CAK1062 Optical Connector Assembly Tool Set contains an S3200-FC200 Optical Fiber Cutter.

Optical Power Tester Sets

Model Number	Head Unit*	Applicable Units/Boards
S3200-CAT3200	S3200-CAT3202	SYSMAC NET Link: S3200-LSU03-01E, C500-SNT31-V4, S3200-NSUG4-00E, S3200-NSUA1-00E, S3200-NSB11-E, FIT10-IF401
S3200-CAT2000	S3200-CAT2002	SYSMAC NET Link: C200H-SNT31, CV500-SNT31
S3200-CAT2700	S3200-CAT2702	SYSMAC LINK: C200H-SLK11, C1000H-SLK11, CV500-SLK11 SYSMAC BUS/2: CV500-RM211, CV500-RT211
S3200-CAT2820	S3200-CAT2822	SYSMAC BUS: C500-RM001-(P)EV1, C120-RM001(-P)-E, C200H-RM001-PV1, C500-RT001-(P)EV1, C500-RT002-(P)EV1, C200H-RT001-P, C200H-RT002-P, C500-LK010(-P)-E, C120-LK010(-P)-E, 3G2C7-LK011(-P), 3G5A2-□□□-PE SYSMAC Host Link: C500-LK103(-P), C500-LK101-(P)EV1, C200H-LK101-P, 3G2A6-LK101-(P)EV1

Note *The Head Unit is the light source and connector adapter included in the Optical Power Tester Set. All parts of the Optical Power Tester Sets are compatible except the Head Units, which differ according to the optical module (for series of units and boards). When more than one Head Unit is required, specify one of the Optical Power Tester Sets and the other Head Units required.

Master Fiber Sets

Model Number	Applicable Head Unit
S3200-CAT3201	S3200-CAT3202
S3200-CAT2001H	S3200-CAT2002, S3200-CAT2702
S3200-CAT2821	S3200-CAT2822

Note The applicable Head Unit is determined by the connector adapter in the Head Unit that fits the master fiber.

Glossary

dBm	A unit for expressing power level in decibels, relative to a reference level of one milliwatt.
ferrule	A short tube which is attached to the end of an optical fiber and is part of the optical fiber connector.
H-PCF	Hard-clad plastic cable fiber.
LAN	An acronym for local area network.
local area network	A network consisting of nodes or positions in a loop arrangement. Each node can be any one of a number of devices. This kind of network usually operates over a small area such as a group of offices or a factory floor.
Programmable Controller	A small, computer-like device that can control peripheral equipment, such as an electric door or quality control devices, based on programming and peripheral input devices. Any process that can be controlled using electrical signals can be controlled by a PC. PCs can be used independently or networked together into a system to control more complex operations.
pull box	A box which allows access to optical fiber cable in a conduit. Pull boxes are used to pull the cable through sections of conduit during installation.
PVC	Polyvinyl chloride. The outer layer or sheath on the optical fiber cable.
tension member	A steel wire running through an optical fiber cable. It is used to give the cable longitudinal strength.

Index

B

baseband frequency, 4

C

cable length, increasing, 34

conduit, installing cord or cable in conduit, 27, 30

connectors

assembly, 17

attaching, 34

construction, 16

contents of Optical Connector Assembly Tool Kit, 18

corresponding units/boards, 15

Optical Connector dimensions, 14

cord length, increasing, 34

D

ducts, installing cord or cable in ducts, 32

E

elevated installation, suspending cord or cable from support
cable, 32

I

Inline Adapter, testing optical power transmission, 21

inspection, points inspected prior to shipping, 12

installation

cable preparation, 26

cord preparation, 24

elevated, 32

in conduit, 27, 30

in ducts, 32

in racks, 29

in troughs, 29

introduction, 24

recommended installation methods, 24

securing the cord or cable, 33

M

Master Fiber Sets, 19

N

numerical aperture, 4

O

Optical Connector Assembly Tool Kit, 18

Optical Fiber Cable

component materials, 9

preparation for installation, 26

specifications, 10

Optical Fiber Cord

component materials, 8

preparation for installation, 24

specifications, 10

Optical Power Testers, 19

ordering information, 35

R

rack, installing cord or cable in racks, 29

S

signal loss

vs. temperature, 5

vs. transmission distance, 3

vs. wavelength, 3

specifications, 10

standard models, 35

T

testing

optical power testing, 19

using Optical Power Testers, 20

transmission loss. *See* signal loss

trough, installing cord or cable in troughs, 29

Revision History

A manual revision code appears as a suffix to the catalog number on the front cover of the manual.

Cat. No. W156-E1-3

↑
Revision code

The following table outlines the changes made to the manual during each revision. Page numbers refer to the previous version.

Revision code	Date	Revised content
1	November 1989	Original production
2	March 1990	New text added and some new graphics.
3	July 1993	Extensively rewritten with new information added.

OMRON Corporation

FA Systems Division H.Q.
66 Matsumoto
Mishima-city, Shizuoka 411-8511
Japan
Tel: (81)55-977-9181/Fax: (81)55-977-9045

Regional Headquarters

OMRON EUROPE B.V.

Wegalaan 67-69, NL-2132 JD Hoofddorp
The Netherlands
Tel: (31)2356-81-300/Fax: (31)2356-81-388

OMRON ELECTRONICS LLC

1 East Commerce Drive, Schaumburg, IL 60173
U.S.A.
Tel: (1)847-843-7900/Fax: (1)847-843-8568

OMRON ASIA PACIFIC PTE. LTD.

83 Clemenceau Avenue,
#11-01, UE Square,
Singapore 239920
Tel: (65)6835-3011/Fax: (65)6835-2711

OMRON

Authorized Distributor: