

22.5-mm-width Timers

H3DKZ



Range of DIN Track-mounted, Standard 22.5-mm-width Timers

- A wide AC/DC power supply range (24 to 240 VAC/DC).*
- ON-delay Timers and Twin Timers include models with 12-VDC power supply.*
- G-type Models (H3DKZ-G) now include model with 240 to 440-VAC power supply.
- EN 61812-1 compliance, CE Marking, and CCC certification.
- Finger-safe terminal block.

*.Except for the H3DKZ-H.



Model Number Structure

■ The Entire H3DKZ Series

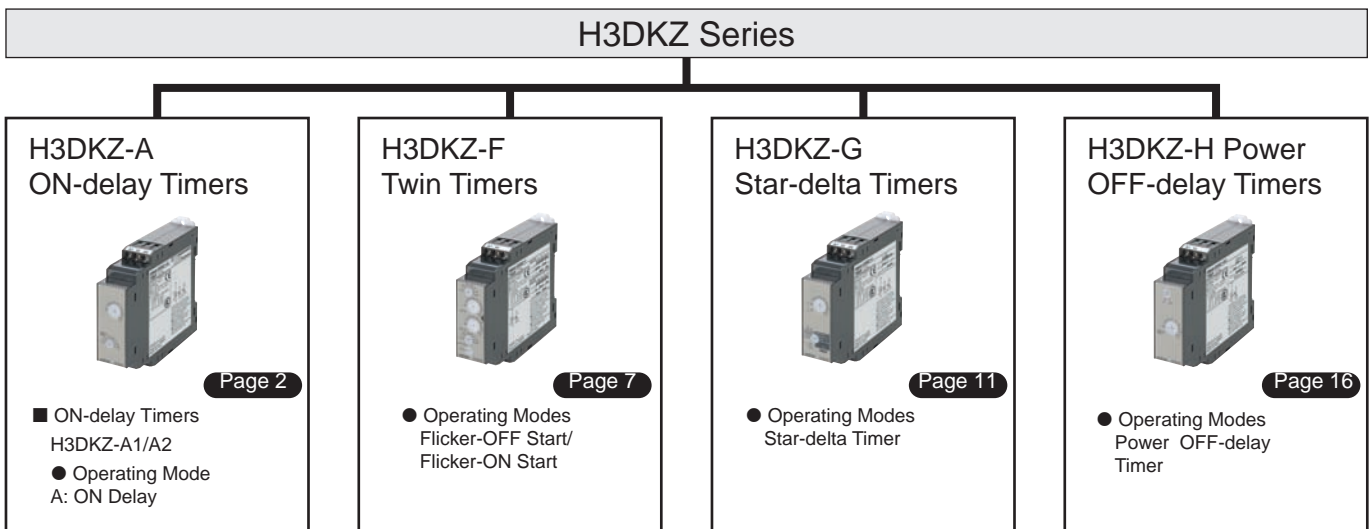

■ Model Number Legend (Not all models that can be represented with the model number legend can necessarily be produced.)

H3DKZ-□□□□
1 2 3 4

1. Type

Symbol	Meaning
A	ON-delay Timer
F	Twin Timer
G	Star-delta Timer
H	Power OFF-delay Timer

2. Control Output

Symbol	Meaning
1	SPDT
2	DPDT

* A-type models only.

3. Supply Voltage

Symbol	Meaning
Blank	24 to 240 VAC/DC
A	12 VDC
B	24 to 48 VAC/DC
C	100 to 120 VAC
D	200 to 240 VAC
E	240 to 440 VAC *

* G-type models only.

4. Time Ranges (H-type Models Only)

Symbol	Meaning
L	1 to 12 s or 10 to 120 s

ON-delay Timer H3DKZ-A

- A wide time setting range of 0.10 s to 1200 h.
- Single mode (On-delay) Timer.
- A wide AC/DC power supply range (24 to 240 VAC/DC).
- Models with 12-VDC power supply available.



Ordering Information

List of Models

Supply voltage	Control output	Model
24 to 240 VAC/DC	SPDT (time-limit output)	H3DKZ-A1
	DPDT (time-limit output)	H3DKZ-A2
12 VDC	SPDT (time-limit output)	H3DKZ-A1A
	DPDT (time-limit output)	H3DKZ-A2A

Accessories (Order Separately)

Item	Specification	Model
Mounting Track	50 cm (l) x 7.3 mm (t)	PFP-50N
	1 m (l) x 7.3 mm (t)	PFP-100N
	1 m (l) x 16 mm (t)	PFP-100N2
End Plate	---	PFP-M
Spacer	---	PFP-S

Model Structure

Model	Operating modes	Terminal block	Output type	Mounting method	Accessories
H3DKZ-A2	A: ON Delay	9 terminals	Relay, DPDT	DIN Track mounting	User label
H3DKZ-A1		6 terminals	Relay, SPDT		

Specifications

Time Ranges

Time range setting	0.1 s	1 s	10 s	1 min	10 min	1 h	10 h	100 h
Set time range	0.1 to 1.2 s	1 to 12 s	10 to 120 s	1 to 12 min	10 to 120 min	1 to 12 h	10 to 120 h	100 to 1,200 h
Scale numbers	12							

Ratings

Power supply voltage ^{*1}	<ul style="list-style-type: none"> • 24 to 240 VAC/DC, 50/60 Hz ^{*2} • 12 VDC ^{*2} 	
Allowable voltage fluctuation range	<ul style="list-style-type: none"> • 24 to 240 VAC/DC: 85% to 110% of rated voltage • 12 VDC: 90% to 110% of rated voltage 	
Power reset	Minimum power-OFF time: 0.1 s	
Reset voltage	10% of rated voltage ^{*3}	
Power consumption ^{*4}	H3DKZ-A1	At 240 VAC: 6.6 VA max.
	H3DKZ-A2	At 240 VAC: 4.5 VA max.
Control output	Contact output, 5 A at 250 VAC with resistive load (cosφ = 1), 5 A at 30 VDC with resistive load	
Ambient operating temperature	-20 to 55°C (with no icing)	
Storage temperature	-40 to 70°C (with no icing)	
Ambient operating humidity	25% to 85%	

- *1. When using a 24-VDC power supply voltage, there will be an inrush current of approximately 0.25 A. Allow for this inrush current when turning ON and OFF the power supply to the Timer with device with a solid-state output, such as a sensor.
- *2. DC ripple: 20% max.
- *3. Actual value
- *4. The power consumption is for mode A after the Timer times out.
- *5. Refer to *DC Power Consumptions (Reference Information)* on page 21 for DC power consumptions.

Characteristics

Accuracy of operating time	±1% of FS max.																				
Setting error	±5% of FS *																				
Influence of voltage	±2% of FS max. *																				
Influence of temperature	±5% of FS max. *																				
Dielectric strength	<p>Between current-carrying metal parts and exposed non-current-carrying metal parts: 2,000 VAC 50/60 Hz for 1 min.</p> <p>Between control output terminals and operating circuit: 2,000 VAC 50/60 Hz for 1 min.</p> <p>Between contacts of different polarity: 2,000 VAC 50/60 Hz for 1 min.</p> <p>Between contacts not located next to each other: 1,000 VAC 50/60 Hz for 1 min.</p>																				
Static immunity	Malfunction: 4 kV, Destruction: 8 kV																				
Vibration resistance	Destruction	0.75-mm single amplitude at 10 to 55 Hz for 2 h each in 3 directions																			
	Malfunction	0.5-mm single amplitude at 10 to 55 Hz for 10 min each in 3 directions																			
Shock resistance	Destruction	1,000 m/s ² 3 times each in 6 directions																			
	Malfunction	100 m/s ² 3 times each in 6 directions																			
Life expectancy	Mechanical	10 million operations min. (under no load at 1,800 operations/h)																			
	Electrical	100,000 operations min. (5 A at 250 VAC, resistive load at 360 operations/h)																			
EMC	<table> <tr> <td>(EMI)</td> <td>EN61812-1</td> </tr> <tr> <td>Radiated Emissions:</td> <td>EN 55011 class B</td> </tr> <tr> <td>Emission AC Mains:</td> <td>EN 55011 class B</td> </tr> <tr> <td>Harmonic Current:</td> <td>EN 61000-3-2</td> </tr> <tr> <td>Voltage Fluctuations and Flicker:</td> <td>EN61000-3-3</td> </tr> <tr> <td>(EMS)</td> <td>EN61812-1</td> </tr> <tr> <td>ESD Immunity:</td> <td>EN 61000-4-2: 6 kV contact discharge, 8 kV air discharge</td> </tr> <tr> <td>Radiated Radio-Frequency Electromagnetic Field Immunity (AM Radio Waves):</td> <td>EN 61000-4-3: 10 V/m (80 MHz to 1 GHz)</td> </tr> <tr> <td>Burst Immunity:</td> <td>EN 61000-4-4: 2 kV power line, 1 kV I/O signal line</td> </tr> <tr> <td>Surge Immunity:</td> <td>EN 61000-4-5: 2 kV common mode, 1 kV differential mode</td> </tr> </table>	(EMI)	EN61812-1	Radiated Emissions:	EN 55011 class B	Emission AC Mains:	EN 55011 class B	Harmonic Current:	EN 61000-3-2	Voltage Fluctuations and Flicker:	EN61000-3-3	(EMS)	EN61812-1	ESD Immunity:	EN 61000-4-2: 6 kV contact discharge, 8 kV air discharge	Radiated Radio-Frequency Electromagnetic Field Immunity (AM Radio Waves):	EN 61000-4-3: 10 V/m (80 MHz to 1 GHz)	Burst Immunity:	EN 61000-4-4: 2 kV power line, 1 kV I/O signal line	Surge Immunity:	EN 61000-4-5: 2 kV common mode, 1 kV differential mode
(EMI)	EN61812-1																				
Radiated Emissions:	EN 55011 class B																				
Emission AC Mains:	EN 55011 class B																				
Harmonic Current:	EN 61000-3-2																				
Voltage Fluctuations and Flicker:	EN61000-3-3																				
(EMS)	EN61812-1																				
ESD Immunity:	EN 61000-4-2: 6 kV contact discharge, 8 kV air discharge																				
Radiated Radio-Frequency Electromagnetic Field Immunity (AM Radio Waves):	EN 61000-4-3: 10 V/m (80 MHz to 1 GHz)																				
Burst Immunity:	EN 61000-4-4: 2 kV power line, 1 kV I/O signal line																				
Surge Immunity:	EN 61000-4-5: 2 kV common mode, 1 kV differential mode																				
Degree of protection	IP30 (Terminal block: IP20)																				
Weight	Approx. 120 g																				

* Actual value.

H3DKZ-A

Connections

■ Block Diagrams

H3DKZ-A1□/□A2□

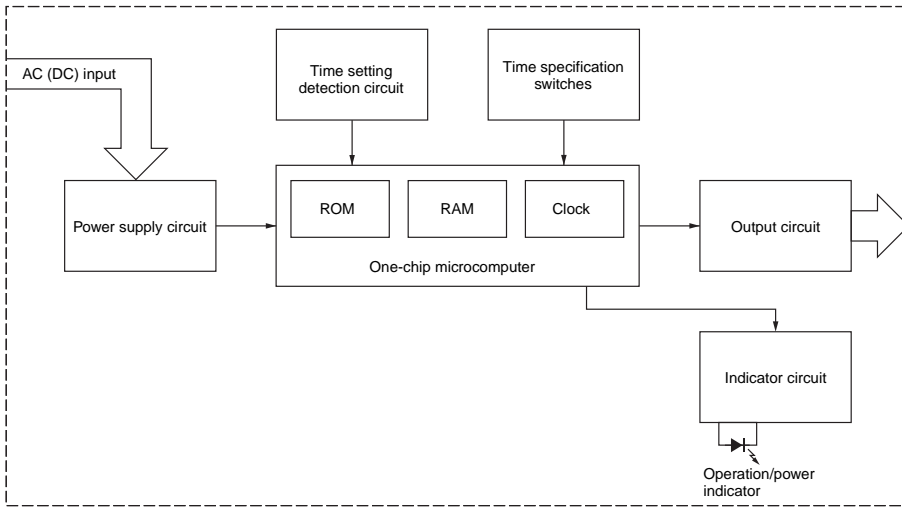

■ Terminal Arrangement

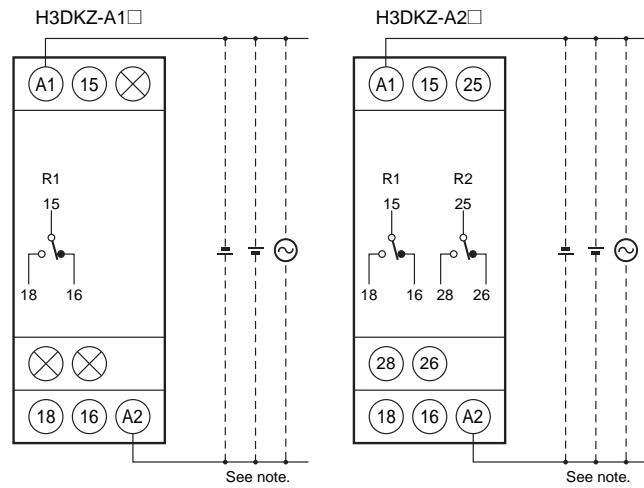

Note: The power supply terminals do not have polarity.

(DIN notation)

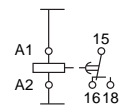

(DIN notation)

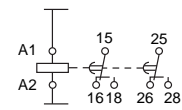

Nomenclature

H3DKZ-A1

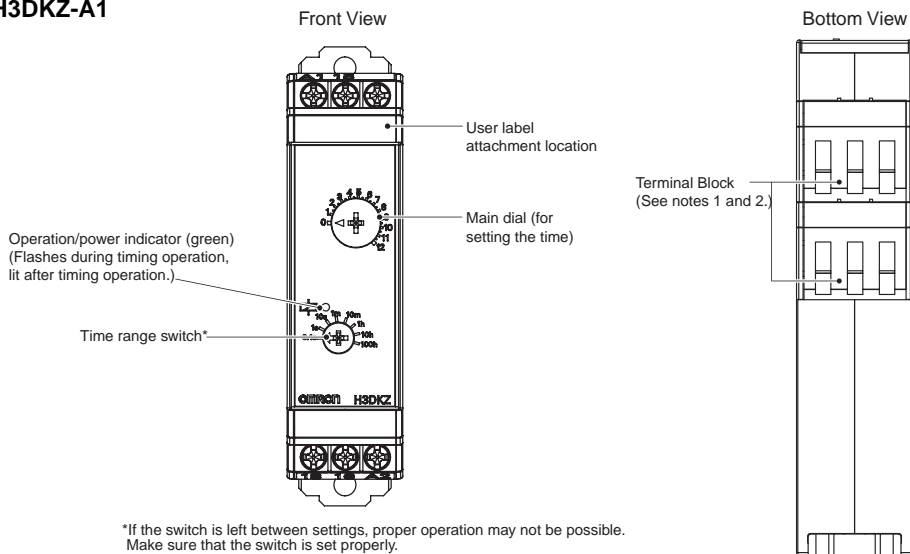

Note 1. Use solid wire (2.5 mm² max.) or ferrules with insulative sleeves to connect to the terminals. To maintain the withstand voltage after connecting the terminals, insert no more than 8 mm of exposed conductor into the terminal.

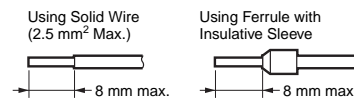

Recommended Ferrules

Phoenix Contact

• AI□□□ Series

• AI-TWIN□□□ Series

Note 2. Screw Tightening Torque
Recommended torque: 0.49 N·m
Maximum torque: 0.98 N·m

H3DKZ-A2

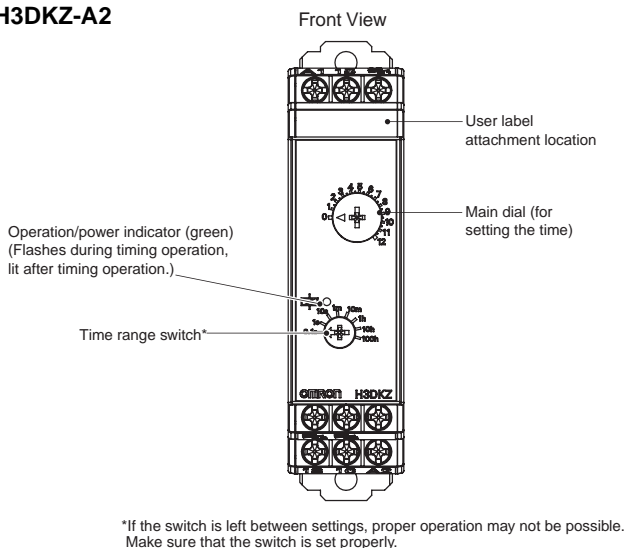

Dimensions

(Unit: mm)

Timers

H3DKZ-A



H3DKZ-A1
H3DKZ-A2

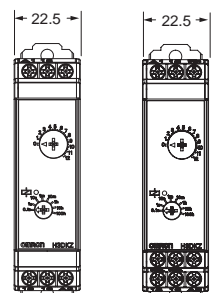

H3DKZ-A1

H3DKZ-A2

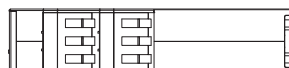
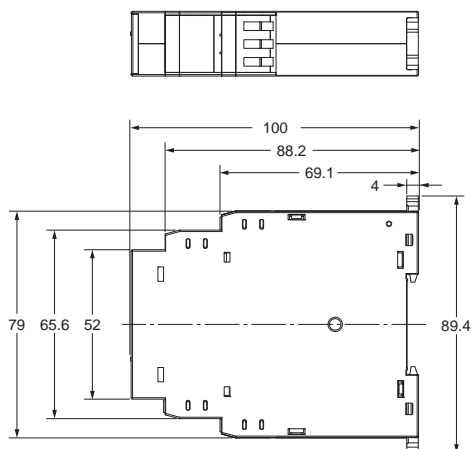

H3DKZ-A

Operating Procedures

■ Basic Operation

● Setting Switches

- Each switch has a snap mechanism that secures the switch at given positions. Set the switch to one of these positions. Do not set it midway between two positions. Malfunction could result from an improper setting.

Setting the Time Range

● Setting the Time Range

The time range switch can be used to set the time range. Turn the switch with a flat-blade or Phillips screwdriver.

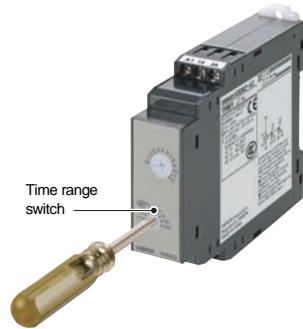

■ Timing Charts

Note 1. The minimum power reset time is 0.1 s.

Note 2. The letter "t" in the timing charts stands for the set time and "t-a" means that the period is less than the time set.

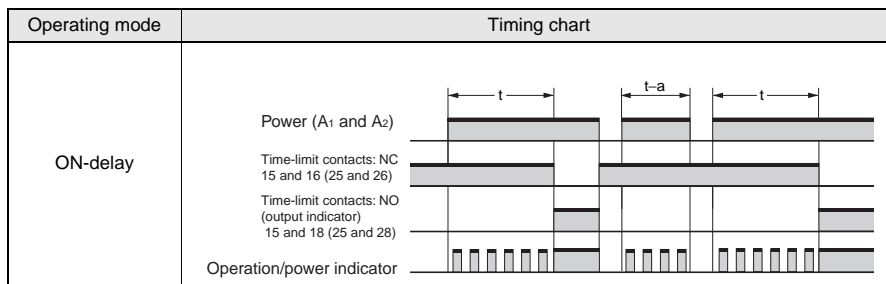

Twin Timer H3DKZ-F

- Switch between flicker-OFF or flicker-ON start mode.
- Independent ON time and OFF time settings.
- Eight time ranges from 0.1 s to 1,200 h.



Ordering Information

List of Models

Supply voltage	Control output	Model
24 to 240 VAC/DC	SPDT (time-limit output)	H3DKZ-F
12 VDC	SPDT (time-limit output)	H3DKZ-FA

Accessories (Order Separately)

Item	Specification	Model
Mounting Track	50 cm (l) x 7.3 mm (t)	PFP-50N
	1 m (l) x 7.3 mm (t)	PFP-100N
	1 m (l) x 16 mm (t)	PFP-100N2
End Plate	---	PFP-M
Spacer	---	PFP-S

Model Structure

Model	Operating modes	Terminal block	Output type	Mounting method	Accessories
H3DKZ-F	Flicker OFF start/flicker ON start	6 terminals	Relay, SPDT	DIN Track mounting	User label

Specifications

Time Ranges

Time range setting	0.1 s	1 s	10 s	1 min	10 min	1 h	10 h	100 h
Set time range	0.1 to 1.2 s	1 to 12 s	10 to 120 s	1 to 12 min	10 to 120 min	1 to 12 h	10 to 120 h	100 to 1,200 h
Scale numbers	12							

Ratings

Power supply voltage ^{*1}	<ul style="list-style-type: none"> • 24 to 240 VAC/DC, 50/60 Hz ^{*2} • 12 VDC ^{*2} 	
Allowable voltage fluctuation range	<ul style="list-style-type: none"> • 24 to 240 VAC/DC: 85% to 110% of rated voltage • 12 VDC: 90% to 110% of rated voltage 	
Power reset	Minimum power-OFF time: 0.1 s	
Reset voltage	10% of rated voltage ^{*3}	
Power consumption	H3DKZ-F	At 240 VAC: 4.5VA max. ^{*4}
	H3DKZ-FA	At 12 VDC: 0.6 W max.
Control output	Contact output (SPDT): 5 A at 250 VAC with resistive load (cosφ = 1) 5 A at 24 VDC with resistive load ^{*3, *4}	
Ambient operating temperature	-20 to 55°C (with no icing)	
Storage temperature	-40 to 70°C (with no icing)	
Ambient operating humidity	25% to 85%	

*1. When using a 24-VDC power supply voltage, there will be an inrush current of approximately 0.25 A. Allow for this inrush current when turning ON and OFF the power supply to the Timer with device with a solid-state output, such as a sensor.

*2. DC ripple: 20% max.

*3. Actual value.

*4. Refer to DC Power Consumptions (Reference Information) on page 21 for DC power consumptions.

■ Characteristics

Accuracy of operating time	±1% of FS max.	
Setting error	±5% of FS ±0.05 s max. *	
Influence of voltage	±2% of FS max. *	
Influence of temperature	±5% of FS max. *	
Dielectric strength	Between current-carrying metal parts and exposed non-current-carrying metal parts: 2,000 VAC 50/60 Hz for 1 min. Between control output terminals and operating circuit: 2,000 VAC 50/60 Hz for 1 min. Between contacts not located next to each other: 1,000 VAC 50/60 Hz for 1 min.	
Vibration resistance	Destruction	0.75-mm single amplitude at 10 to 55 Hz for 2 h each in 3 directions
	Malfunction	0.5-mm single amplitude at 10 to 55 Hz for 10 min each in 3 directions
Shock resistance	Destruction	1,000 m/s ² 3 times each in 6 directions
	Malfunction	100 m/s ² 3 times each in 6 directions
Life expectancy	Mechanical	10 million operations min. (under no load at 1,800 operations/h)
	Electrical	100,000 operations min. (5 A at 250 VAC, resistive load at 360 operations/h)
EMC	(EMI) Radiated Emissions: EN61812-1 EN 55011 class B Emission AC Mains: EN 55011 class B Harmonic Current: EN 61000-3-2 Voltage Fluctuations and Flicker: EN61000-3-3 (EMS) ESD Immunity: EN 61000-4-2: 6 kV contact discharge, 8 kV air discharge Radiated Radio-Frequency Electromagnetic Field Immunity (AM Radio Waves): EN 61000-4-3: 10 V/m (80 MHz to 1 GHz) Burst Immunity: EN 61000-4-4: 2 kV power line, 1 kV I/O signal line Surge Immunity: EN 61000-4-5: 2 kV common mode, 1 kV differential mode	
Degree of protection	IP30 (Terminal block: IP20)	
Weight	Approx. 110 g	

*Actual value.

Connections

■ Block Diagrams

H3DKZ-F

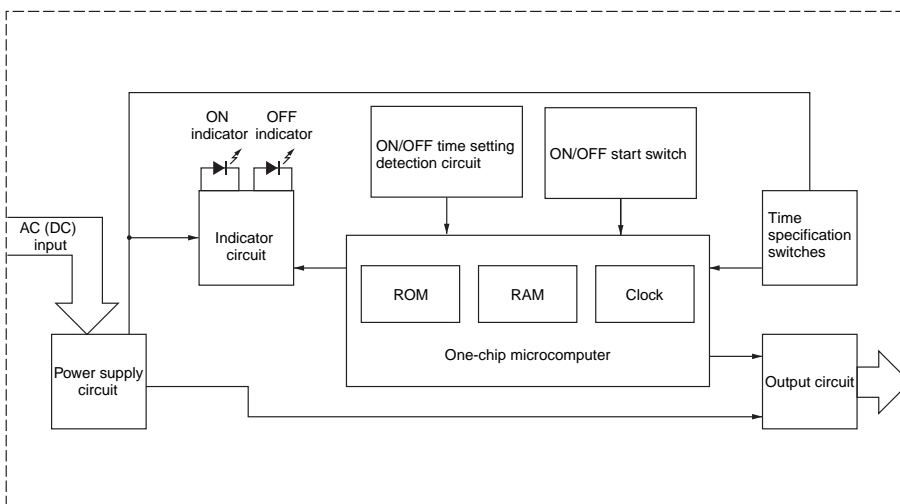

■ Terminal Arrangement

H3DKZ-F

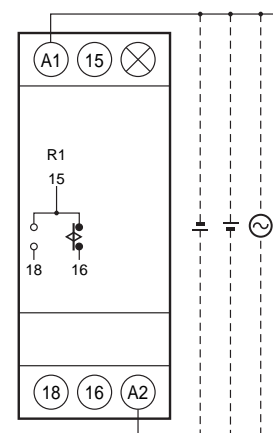

(DIN notation)

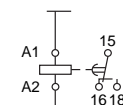

Note: The power supply terminals do not have polarity.

Nomenclature

H3DKZ-F

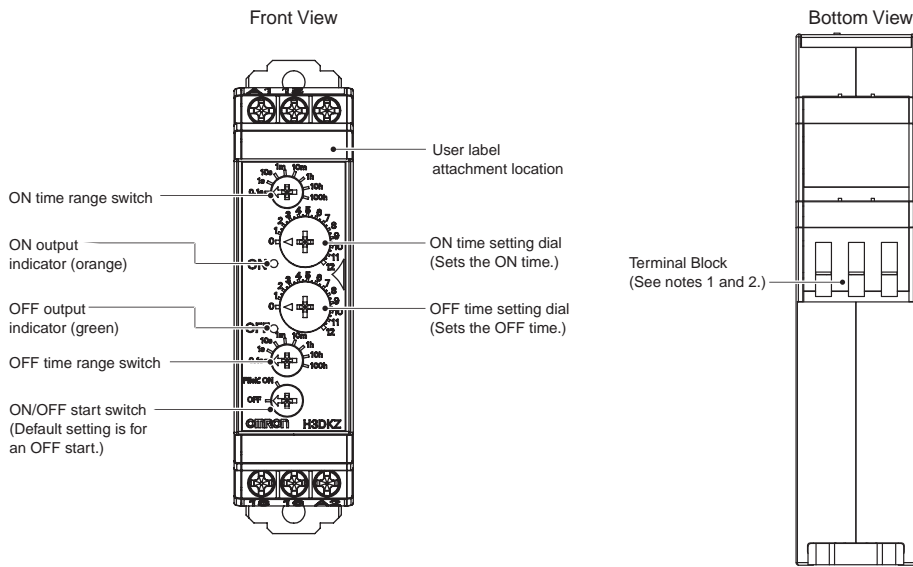

Note 1. Use solid wire (2.5 mm² max.) or ferrules with insulative sleeves to connect to the terminals.
To maintain the withstand voltage after connecting the terminals, insert no more than 8 mm of exposed conductor into the terminal.

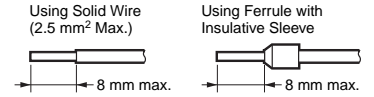

Recommended Ferrules
Phoenix Contact
• AI□□□ Series
• AI-TWIN□□□ Series

Note 2. Screw Tightening Torque
Recommended torque: 0.49 N·m
Maximum torque: 0.98 N·m

Dimensions

(Unit: mm)

■ Timers

H3DKZ-F

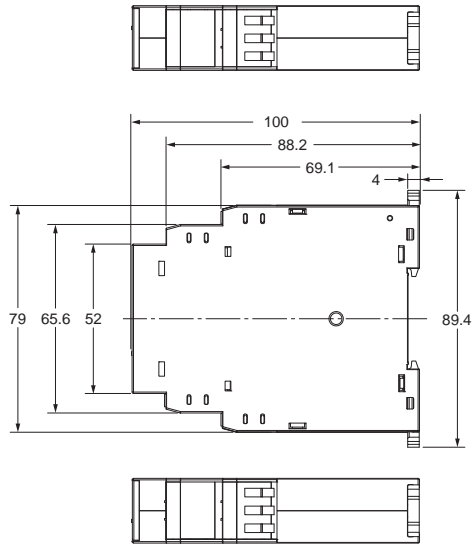
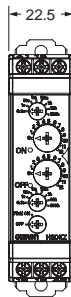

H3DKZ-F

Operating Procedures

Basic Operation

Setting the Time Ranges

● Setting the Time Ranges

Use the ON time range switch to set the ON time range and the OFF time range switch to set the OFF time range. Turn the switches with a flat-blade or Phillips screwdriver.

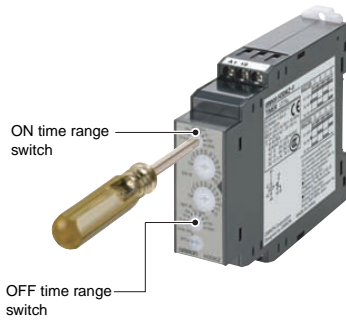

Setting the ON/OFF Start Switch

● Setting an ON Start or OFF Start

The ON/OFF start switch can be used to switch between ON-start and OFF-start operation.

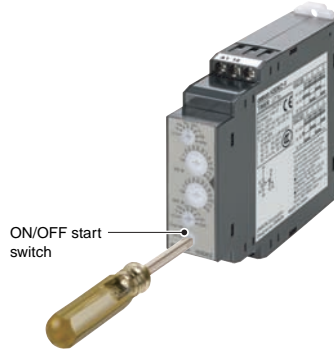

Setting the Times

● Setting the Times

Use the ON time setting dial and the OFF time setting dial to set the ON time and OFF time.

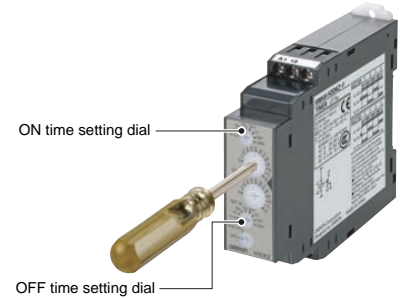

Timing Charts

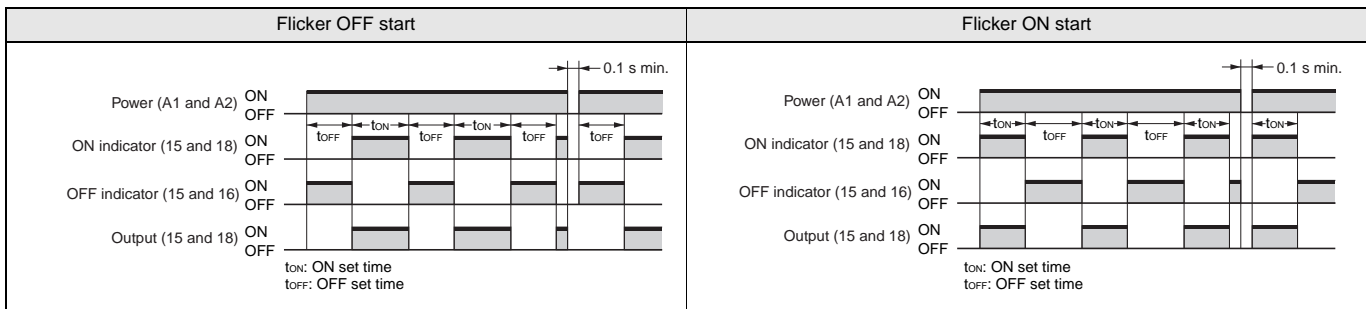

Note 1. The reset time is 0.1 s min.

Note 2. When power is supplied in flicker ON start mode, the OFF indicator lights momentarily. This, however, has no effect on the performance of the Timer.

Star-delta Timer

H3DKZ-G

- Set two time ranges between 1 and 120 s with one Timer.
- Models with 240 to 440-VAC power supply added to series.



Ordering Information

List of Models

Supply voltage	Control output	Model
24 to 240 VAC/DC	Star circuit: SPDT, delta circuit: SPDT	H3DKZ-G
240 to 440 VAC/DC	Star circuit: SPDT, delta circuit: SPDT	H3DKZ-GE

Accessories (Order Separately)

Item	Specification	Model
Mounting Track	50 cm (l) x 7.3 mm (t)	PFP-50N
	1 m (l) x 7.3 mm (t)	PFP-100N
	1 m (l) x 16 mm (t)	PFP-100N2
End Plate	---	PFP-M
Spacer	---	PFP-S

Model Structure

Model	Terminal block	Operating/resetting method	Output type	Mounting method	Accessories
H3DKZ-G	9 terminals	Time-limit operation/self-resetting	Time-limit (relay) Star circuit: SPDT Delta circuit: SPDT	DIN Track mounting	User label

Specifications

Time Ranges

Time range setting	t1x1	t1x10
Star set time (t1) range	1 to 12 s	10 to 120 s
Star-Delta transfer time (t2)	Select from 0.05, 0.1, 0.25, or 0.5 s.	

Ratings

	H3DKZ-G	H3DKZ-GE
Power supply voltage ^{*1}	• 24 to 240 VAC/DC, 50/60 Hz ^{*2}	• 240 to 440 VAC (50/60 Hz)
Allowable voltage fluctuation range	• 24 to 240 VAC/DC: 85% to 110% of rated voltage • 240 to 440 VAC: 80% to 110% of rated voltage	
Power reset	Minimum power-OFF time: 0.5 s	
Reset voltage	10% of rated voltage ^{*3}	
Power consumption	At 240 VAC: 6.6 VA max. ^{*4}	At 440 VAC: 34 VA max.
Control output	Contact output (Time-limit output: relay, Star output: SPDT, Delta output: SPDT): 5 A at 250 VAC with resistive load (cosφ = 1) 5 A at 24 VDC with resistive load ^{*4,*5}	1 th 2 A AC-15 120 VAC: 1.5 A AC-15 240 VAC: 1 A AC-15 440 VAC: 0.3 A
Ambient operating temperature	-20 to 55°C (with no icing)	
Storage temperature	-40 to 70°C (with no icing)	
Ambient operating humidity	25% to 85%	

*1. When using a 24-VDC power supply voltage, there will be an inrush current of approximately 0.25 A. Allow for this inrush current when turning ON and OFF the power supply to the Timer with device with a solid-state output, such as a sensor.

*2. DC ripple: 20% max.

*3. Actual value.

*4. Refer to *DC Power Consumptions (Reference Information)* on page 21 for DC power consumptions.

*5. 125 VDC: 0.15 A max. with resistive load, 125 VDC: 0.1 A with L/R of 7 ms.
Minimum load: 10 mA at 5 VDC (P level, reference value)

■ Characteristics

		H3DKZ-G	H3DKZ-GE
Accuracy of operating time		±1% of FS max.	
Setting error		±5% of FS ±0.05 s max. *1	
Transfer time		Total error ± (25% of transfer time + 5 ms) max. *1	
Influence of voltage		±2% of FS max. *1	
Influence of temperature		±5% of FS max. *1	
Dielectric strength		Between current-carrying metal parts and exposed non-current-carrying metal parts: 2,000 VAC 50/60 Hz for 1 min. *2 Between control output terminals and operating circuit: 2,000 VAC 50/60 Hz for 1 min. *2 Between contacts of different polarity: 2,000 VAC 50/60 Hz for 1 min. *2 Between contacts not located next to each other: 1,000 VAC 50/60 Hz for 1 min.	
Vibration resistance	Destruction	0.75-mm single amplitude at 10 to 55 Hz for 2 h each in 3 directions	
	Malfunction	0.5-mm single amplitude at 10 to 55 Hz for 10 min each in 3 directions	
Shock resistance	Destruction	1,000 m/s ² 3 times each in 6 directions	
	Malfunction	100 m/s ² 3 times each in 6 directions	
Life expectancy	Mechanical	10 million operations min. (under no load at 1,800 operations/h)	10 million operations min. (under no load at 1,800 operations/h)
	Electrical	100,000 operations min. (5 A at 250 VAC, resistive load at 360 operations/h)	100,000 operations min. (0.3 A at 440 VAC, resistive load at 1,800 operations/h)
EMC		(EMI)EN61812-1 Radiated Emissions:EN 55011 class B Emission AC Mains:EN 55011 class B Harmonic Current:EN 61000-3-2 Voltage Fluctuations and Flicker:EN61000-3-3 (EMS)EN61812-1 ESD Immunity:EN 61000-4-2: 6 kV contact discharge, 8 kV air discharge Radiated Radio-Frequency Electromagnetic Field Immunity (AM Radio Waves): EN 61000-4-3: 10 V/m (80 MHz to 1 GHz) Burst Immunity:EN 61000-4-4: 2 kV power line, 1 kV I/O signal line Surge Immunity:EN 61000-4-5: 2 kV common mode, 1 kV differential mode	
Degree of protection		IP30 (Terminal block: IP20)	
Weight		Approx. 120 g	

*1. Actual value.

*2. The dielectric strength of the H3DKZ-GE (240 to 440 VAC) is 2,500 VAC 50/60 Hz.

Connections

Block Diagrams

H3DKZ-G

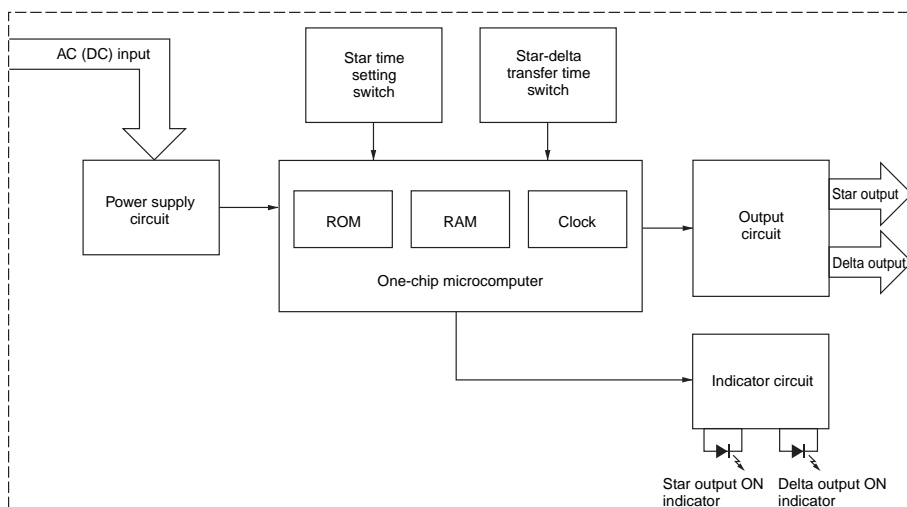

Terminal Arrangement

H3DKZ-G

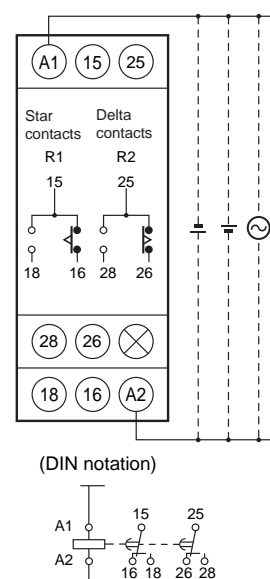

Note: The power supply terminals do not have polarity.

Nomenclature

H3DKZ-G

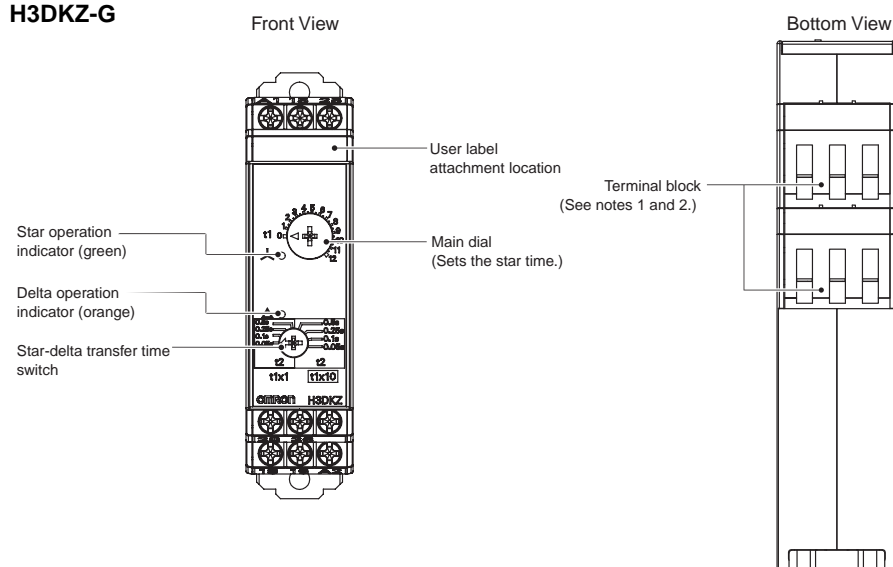

Note 1. Use solid wire (2.5 mm² max.) or ferrules with insulative sleeves to connect to the terminals.

To maintain the withstand voltage after connecting the terminals, insert no more than 8 mm of exposed conductor into the terminal.

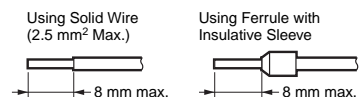

Recommended Ferrules
Phoenix Contact
• AI□□□ Series
• AI-TWIN□□□ Series

Note 2. Screw Tightening Torque
Recommended torque: 0.49 N·m
Maximum torque: 0.98 N·m

H3DKZ-G

H3DKZ-GE

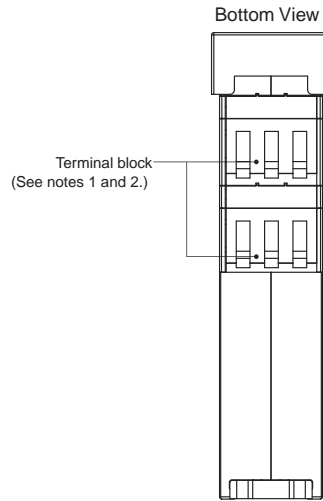
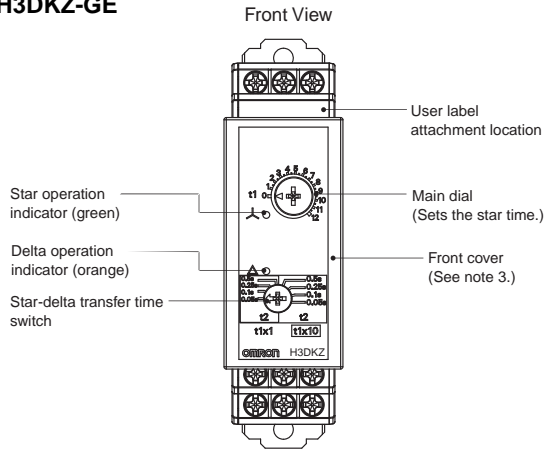

Note 1. Use solid wire (2.5 mm² max.) or ferrules with insulative sleeves to connect to the terminals.
To maintain the withstand voltage after connecting the terminals, insert no more than 8 mm of exposed conductor into the terminal.

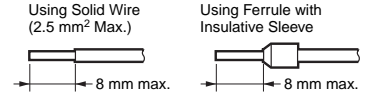

Recommended Ferrules

- Phoenix Contact
 • AI□□□ Series
 • AI-TWIN□□□ Series

Note 2. Screw Tightening Torque
 Recommended torque: 0.49 N·m
 Maximum torque: 0.98 N·m

Note 3. Always keep the front cover mounted when using the Timer.

Dimensions

(Unit: mm)

Timers

H3DKZ-G

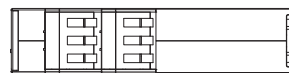
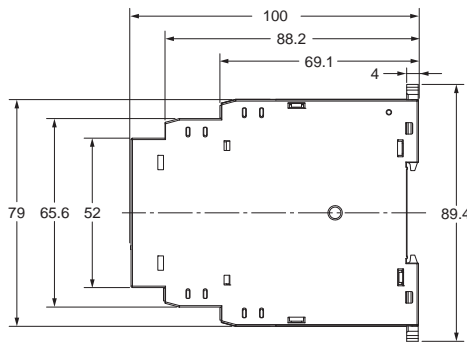
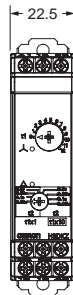

H3DKZ-GE

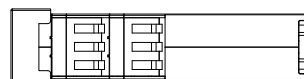
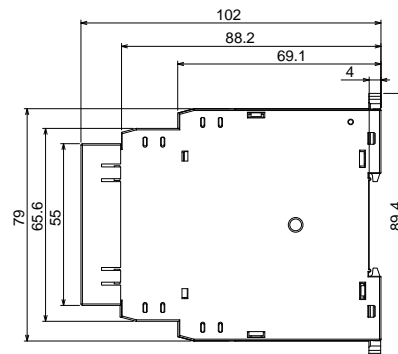
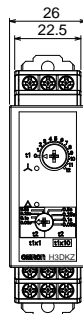

Operating Procedures

Basic Operation



● Setting the Delta Time Range and the Star-delta Transfer Time (t2)

Star Time (t1) Range

Set the star-delta transfer time.

For ×1 (1 to 12 s), use side (A) (labeled “t1×1”).

For ×10 (10 to 120 s), use side (B) (labeled “t1×10”).

(See following diagram.)

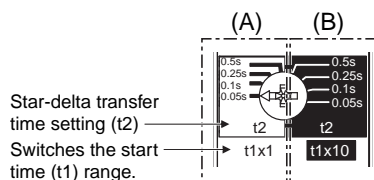

● Setting the Time

The start time is set with the main dial.

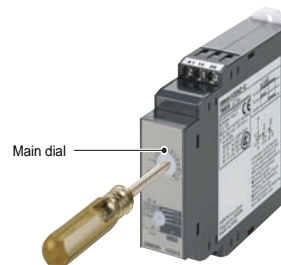

Timing Chart

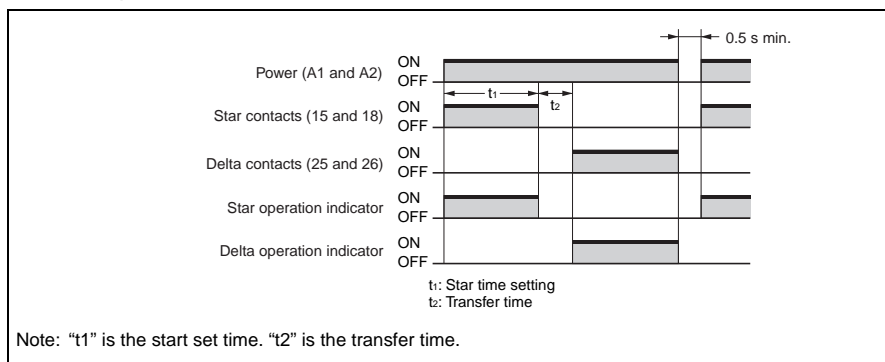

Power OFF-delay Timer H3DKZ-H

- Set two time ranges, from 1 to 120 seconds.



Ordering Information

■ List of Models

Supply voltage	Control output	Model
100 to 120 VAC	SPDT	H3DKZ-HCL
200 to 240 VAC	SPDT	H3DKZ-HDL

■ Accessories (Order Separately)

Item	Specification	Model
Mounting Track	50 cm (l) x 7.3 mm (t)	PFP-50N
	1 m (l) x 7.3 mm (t)	PFP-100N
	1 m (l) x 16 mm (t)	PFP-100N2
End Plate	---	PFP-M
Spacer	---	PFP-S

■ Model Structure

Model	Terminal block	Operating/resetting method	Output type	Mounting method	Accessories
H3DKZ-H	6 terminals	Instantaneous operation/ time-limit reset	Relay, SPDT	DIN Track mounting	User label

Specifications

■ Time Ranges

	L Series	
Time range setting	x1	x10
Set time range	1 to 12 s	10 to 120 s
Power ON time	0.3 s min.	
Scale numbers	12	

■ Ratings

Supply voltage	<ul style="list-style-type: none"> • 100 to 120 VAC, 50/60 Hz • 200 to 240 VAC, 50/60 Hz 	
Allowable voltage fluctuation range	85% to 110% of rated voltage	
Power consumption	H3DKZ-HCL	At 120 VAC: 11.7 VA max.
	H3DKZ-HDL	At 240 VAC: 29.5 VA max.
Control output	Contact output, 5 A at 250 VAC with resistive load ($\cos\phi = 1$), 5 A at 30 VDC with resistive load	
Ambient operating temperature	-20 to 55°C (with no icing)	
Storage temperature	-40 to 70°C (with no icing)	
Ambient operating humidity	25% to 85%	

*The control output ratings are for one H3DKZ operating alone.

■ Characteristics

Accuracy of operating time		±1% of FS max.
Setting error		±5% of FS *
Influence of voltage		±2% of FS max. *
Influence of temperature		±5% of FS max. (±2% ±10 ms max. at 1.2-s range) *
Dielectric strength		Between current-carrying metal parts and exposed non-current-carrying metal parts: 2,000 VAC 50/60 Hz for 1 min. Between control output terminals and operating circuit: 2,000 VAC 50/60 Hz for 1 min. Between contacts not located next to each other: 1,000 VAC 50/60 Hz for 1 min.
Vibration resistance	Destruction	0.75-mm single amplitude at 10 to 55 Hz for 2 h each in 3 directions
	Malfunction	0.5-mm single amplitude at 10 to 55 Hz for 10 min each in 3 directions
Shock resistance	Destruction	1,000 m/s ² 3 times each in 6 directions
	Malfunction	100 m/s ² 3 times each in 6 directions
Life expectancy	Mechanical	10 million operations min. (under no load at 1,200 operations/h)
	Electrical	100,000 operations min. (5 A at 250 VAC, resistive load at 1,200 operations/h)
EMC		(EMI) EN 61812-1 Radiated Emissions: EN 55011 class B Emission AC Mains: EN 55011 class B Harmonic Current: EN 61000-3-2 Voltage Fluctuations and Flicker: EN 61000-3-3 (EMS) EN 61812-1 ESD Immunity: EN 61000-4-2: 6 kV contact discharge, 8 kV air discharge Radiated Radio-Frequency Electromagnetic Field Immunity (AM Radio Waves): EN 61000-4-3: 10 V/m (80 MHz to 1 GHz) Burst Immunity: EN 61000-4-4: 2 kV power line, 1 kV I/O signal line Surge Immunity: EN 61000-4-5: 2 kV common mode, 1 kV differential mode
Degree of protection		IP30 (Terminal block: IP20)
Weight		Approx. 120 g

*Actual value.

H3DKZ-H

Connections

■ Block Diagrams

H3DKZ-H

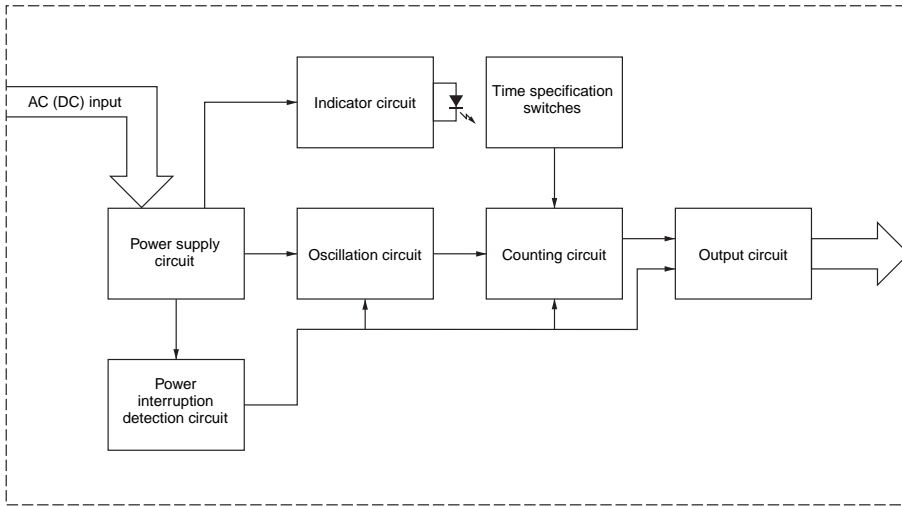

■ Terminal Arrangement

H3DKZ-H

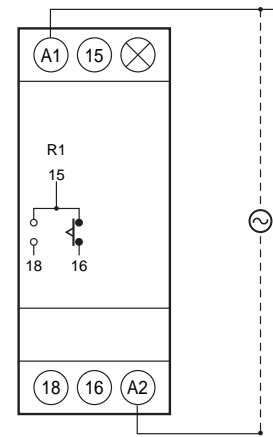

(DIN notation)

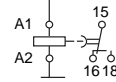

Note: The power supply terminals do not have polarity.

Nomenclature

H3DKZ-H

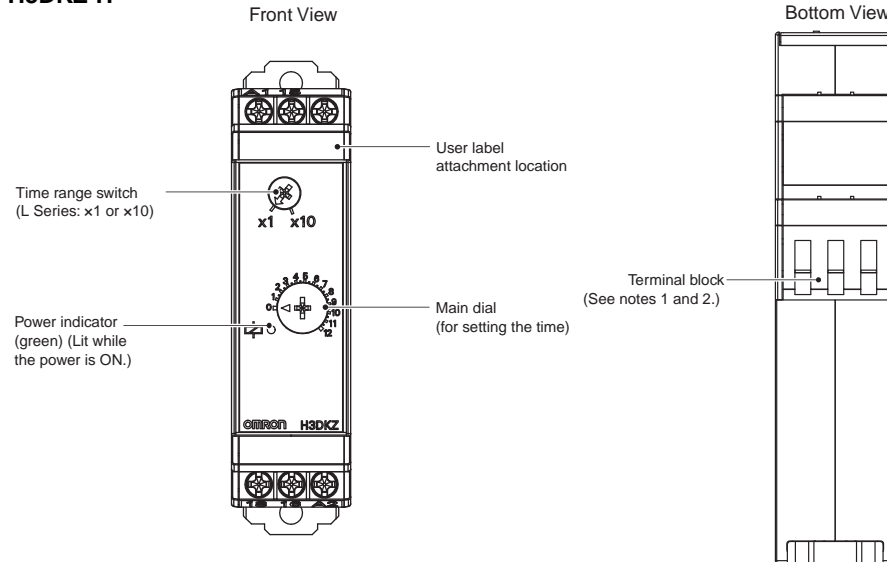

Note 1. Use solid wire (2.5 mm² max.) or ferrules with insulative sleeves to connect to the terminals.
To maintain the withstand voltage after connecting the terminals, insert no more than 8 mm of exposed conductor into the terminal.

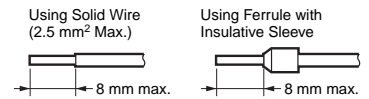

Recommended Ferrules

Phoenix Contact

- AI□□□ Series
- AI-TWIN□□□ Series

Note 2. Screw Tightening Torque
Recommended torque: 0.49 N·m
Maximum torque: 0.98 N·m

Dimensions

Timers

H3DKZ-H

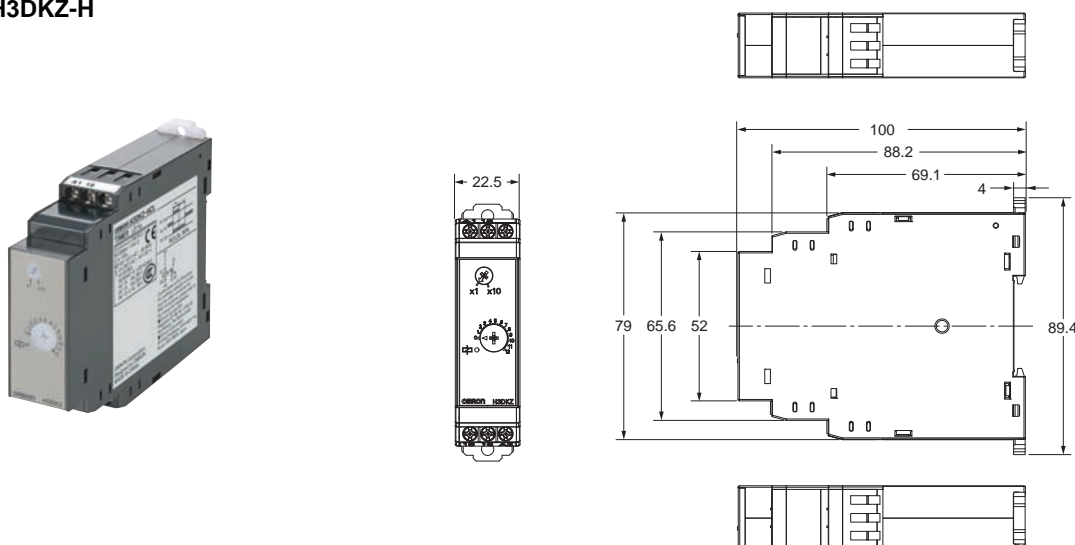

Operating Procedures

Basic Operation

Setting the Time Ranges

● Setting the Time Ranges

The scale multiplier can be changed with the timer range switch. It can be changed between $\times 1$ s and $\times 10$ s for an L-series Timer.

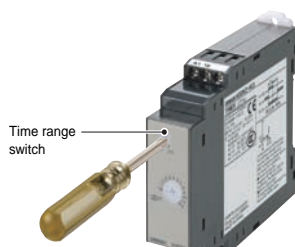

Setting the Time

● Setting the Time

The operation time is set with the main dial.

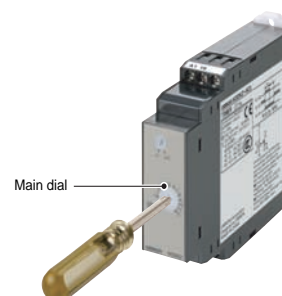

Timing Charts

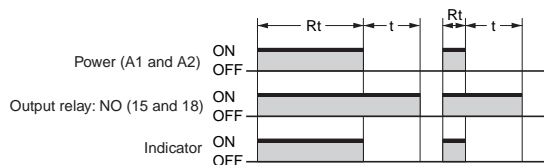

t: Set time

Rt: Minimum power-ON time L Series: 0.3 s min.

(The output may never turn ON if the power is not ON for at least this time.)

H3DKZ

Safety Precautions

● Refer to Safety Precautions for All Timers.

Note: The following is common for all H3DKZ models.

Caution

Switching arcs or relay heating may cause fire or explosion. Do not use the Timer in the presence of inflammable or explosive gases. 

The H3DKZ Series uses a transformerless power supply system. An electrical shock may occur if an input terminal is touched while power is being supplied. 

The inrush current will depend on the type of load and may influence the contact switching frequency and number of operations. Check both the rated current and the inrush current, and allow leeway in the circuit design. 

The life of the output relay largely depends on the switching current and other switch conditions. Consider the actual application conditions and do not exceed the rated load or electrical life. If the output relay is used beyond its service life, the contacts may fuse or burning may occur. Also, never exceed the rated load current. When using a heater, also place a thermal switch in the load circuit. 

Do not remove the external case. 

Minor electric shock, fire, or equipment failure may sometimes occur. Do not disassemble, modify, or repair the Timer or touch any internal parts. 

Precautions for Safe Use

- Use ferrules to wire the H3DKZ. If stranded wires are used, wire scraps may enter the Timer, possibly shorting the circuits.
- Rapid changes in temperature or high humidity may cause condensation in Timer circuits, possibly resulting in malfunction or damage to components. Check the application environment.
- Store the Timer within the rated ranges given for the Timer model you are using. If the Timer is stored below -20°C , allow it to warm up for three hours at room temperature before turning ON the power supply.
- Use the Timer within the ambient operating temperature and ambient operating humidity ranges given for the Timer model you are using.
- Use the Timer within the characteristics for water and oil exposure given for the Timer model you are using.
- Do not use the Timer in locations subject to excessive dust, corrosive gas, or direct sunlight.
- Do not use the Timer in locations subject to vibration and shock. Long-term exposure may damage the Timer due to stress.
- Separate the Timer from any sources of excessive static electricity, such as forming materials and pipes carrying power or liquid materials.
- Maintain the variations in the power supply voltage to within the specified allowable range.
- If a voltage that exceeds the rating is applied, internal components may be destroyed.
- Wire all terminals correctly.
- Use only the specified wires for wiring.
Applicable wire gauge: AWG18 to AWG22
- Install and clearly label a switch or circuit breaker so that the operator can quickly turn OFF the power supply.
- If the Timer is left in the timed out condition for a long period of time at high temperatures, internal components (such as electrolytic capacitors) may deteriorate quickly.
- The exterior of the Timer may be damaged by organic solvents (such as thinners or benzene), strong alkali, or strong acids.
- For Timers with AC power input, use a commercial power supply for the power supply voltage. Although some inverters give 50/60 Hz as the output frequency, do not use an inverter output as the power supply for a Timer. Doing so may result in smoking or burning due to internal temperature increases in the Timer.
- Use the same type of wiring for all Timer wiring.
- When disposing of the Timer, observe all local ordinances as they apply.
- The Timer may not operate properly in locations that are subject to sulfide gas, such as in sewers or incinerators. Products that are suitable for operation in sulfide gas are not available for OMRON Timers or general control devices. Seal the Timer to isolate it from sulfide gas. If the Timer cannot be sealed, OMRON can make special products with resistance to sulfide gas for some Timers. Ask your OMRON representative for details.
- Confirm that the power and output indicators are operating normally. Depending on the operating environment, the indicators and plastic parts may deteriorate faster than expected, causing the indicators to fail. Periodically perform inspections and replacements.

Precautions for Correct Use

● Changing Switch Settings

Do not change the time unit, time scale, operating mode, or INIT/TIME switch while the Timer is in operation. Doing so may result in malfunction. Turn OFF the power supply before changing the setting of any switch.

● Mounting and Dismounting

- Although there are no particular mounting restrictions, the Timer should be mounted as horizontally as possible.
- When mounting the Timer on a mounting Track, loosen the two hooks, press the Timer onto the Track, and then insert the hooks.

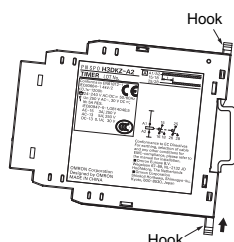

- When removing the Timer, pull out the two hooks, and then remove the Timer from the Track

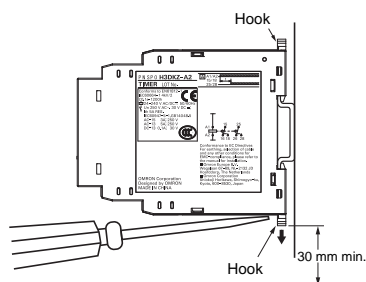

- It will be easier to mount and dismount the Timer if a distance of 30 mm or more is provided between the bottom of the Timer and other equipment.

● Power Supply

- The power supply can be connected to the power input terminals without considering polarity.
- A DC power supply can be connected if its ripple factor is 20% or less and the average voltage is within the allowable voltage fluctuation range of the Timer.
- The H3DKZ-H has a large inrush current. Provide sufficient power supply capacity. If the power supply capacity is too small, there may be delays in turning ON the output.

● Environment

- When using the Timer in an area with excessive electronic noise, separate the Timer and input device as far as possible from the noise sources. It is also recommended to shield the input signal wiring to prevent electronic interference.
- The external impulse voltage entering across the power supply terminals has been checked against a $\pm 1.2 \times 50 \mu\text{s}$ standard waveform according to JEC-210, Impulse Voltage/Current Test, of The Institute of Electrical Engineers of Japan. Surge or noise superimposed on the power supply may damage internal components or cause them to malfunction. We recommend that you check the circuit waveform and use surge absorbers. The effects on components depend on the type of surge and noise that are generated. Always perform testing with the actual equipment.

● Wiring

The H3DKZ-H acts like a high-impedance circuit. Therefore, the Timer may not reset if it is influenced by inductive voltage. To eliminate inductive voltage, the wires connected to the Timer must be as short as possible and should not be installed parallel to power lines. If the Timer is influenced by inductive voltage that is 30% or more of the rated voltage, connect a CR filter with a capacitance of approximately $0.1 \mu\text{F}$ and a resistance of approximately 120Ω or a bleeder resistor between the power supply terminals.

If there is any residual voltage due to current leakage, connect a bleeder resistor between the power supply terminals.

● Operating Frequency

- The H3DKZ-H may malfunction if it is used as shown below. Do not use the H3DKZ-H in these ways.
Timer Repeatedly Times Out in Cycles of 3 s or Less

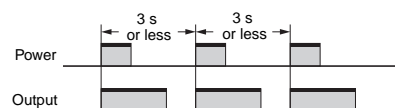

● DC Power Consumptions (Reference Information)

H3DKZ-A1/-A2	At 24 VDC: 1.1 W max.
H3DKZ-F	At 24 VDC: 1.1 W max.
H3DKZ-G	At 24 VDC: 1.2 W max.
H3DKZ-HCL/-HDL	At 24 VDC: 1.2 W max.

● Other Precautions

- If the Timer is mounted on a control panel, dismount the Timer from the control panel before carrying out a voltage withstand test between the electric circuits and non-current-carrying metal parts of the Timer. (Otherwise, the internal circuits of the Timer may be damaged.)
- The H3DKZ-H uses a latching relay for the output. Shock, such as dropping the H3DKZ-H during shipment or handling, can cause the output contacts to reverse to the neutral position. Check the output status with a tester before using the H3DKZ-H.
- The life expectancy of the control output contacts is greatly affected by switching conditions. Always confirm operation using the actual conditions and equipment before using the Timer and make sure that the number of switching operations presents no problems in performance. If Timer application is continued after performance has deteriorated, insulation failure between circuits, burning of the control output relay, or other problem will eventually occur.
- If the power supply voltage is gradually increased, a power reset may occur or the Timer may time out. Use a switch, relay, or other device with contacts to apply the power supply voltage all at once.
- Make sure that residual voltage or inductive voltage is not applied after the power turns OFF.
- Error in the operation time of the Timer is given as a percentage of the full-scale time. The absolute value of the error will not change even if the set time is changed. Therefore, always use the Timer with the set time set as close as possible to the full-scale value of the set time range.
- When switching a microload, check the specified minimum load given for the Timer model you are using.
- When setting the operating time, do not turn the dial beyond the scale range.

-
- If better accuracy is required in the set time, adjust the dial while measuring the operation time.
 - If the Timer is reset immediately after timing out, make sure that the circuit configuration allows sufficient resetting time.

- Errors will occur in the sequence if there is not sufficient resetting time.
- When directly switching a DC load, the switching capacity will be lower than when switching an AC load.
-



EN/IEC Standard Compliance

- Refer to the user manual for the H3DKZ for cable selection and other conditions for compliance with EMC standards.
- The power supply terminals and input terminals are not isolated. There is basic insulation between the power supply terminals and output terminals.
- If double or reinforced insulation is required, use the double or reinforced insulation defined in IEC 60664 that is suitable for the maximum applied voltage for the clearance, solid insulation, and other factors.

Track Mounting Products (Sold Separately)

DIN Track
PFP-100N
PFP-50N

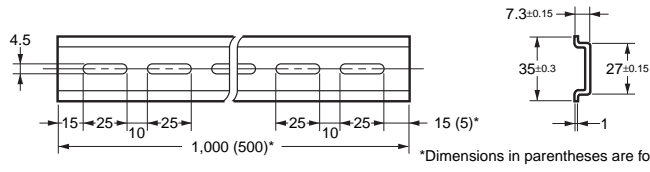
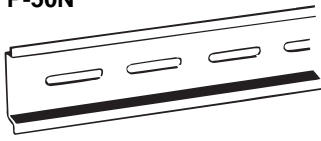

*Dimensions in parentheses are for the PFP-50N.

DIN Track
PFP-100N2

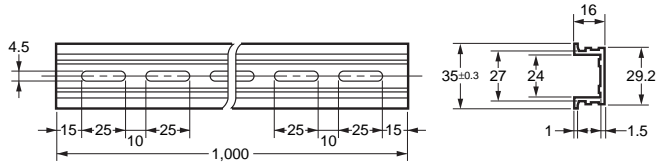
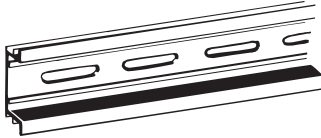

End Plate
PFP-M

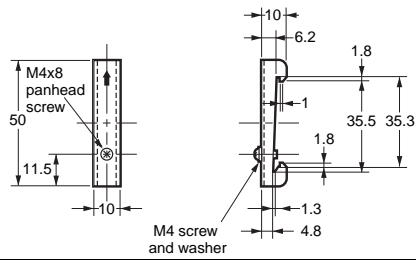

Spacer
PFP-S

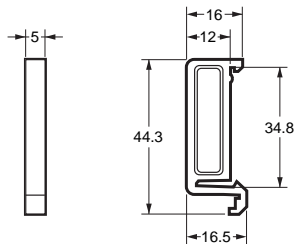
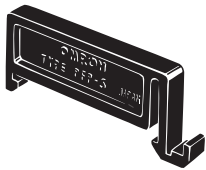

Note 1: Order the above products in multiples of 10.
Note 2: The Tracks conform to DIN standards.

Warranty and Application Considerations

Read and Understand This Catalog

Please read and understand this catalog before purchasing the products. Please consult your OMRON representative if you have any questions or comments.

Warranty and Limitations of Liability

WARRANTY

OMRON's exclusive warranty is that the products are free from defects in materials and workmanship for a period of one year (or other period if specified) from date of sale by OMRON.

OMRON MAKES NO WARRANTY OR REPRESENTATION, EXPRESS OR IMPLIED, REGARDING NON-INFRINGEMENT, MERCHANTABILITY, OR FITNESS FOR PARTICULAR PURPOSE OF THE PRODUCTS. ANY BUYER OR USER ACKNOWLEDGES THAT THE BUYER OR USER ALONE HAS DETERMINED THAT THE PRODUCTS WILL SUITABLY MEET THE REQUIREMENTS OF THEIR INTENDED USE. OMRON DISCLAIMS ALL OTHER WARRANTIES, EXPRESS OR IMPLIED.

LIMITATIONS OF LIABILITY

OMRON SHALL NOT BE RESPONSIBLE FOR SPECIAL, INDIRECT, OR CONSEQUENTIAL DAMAGES, LOSS OF PROFITS, OR COMMERCIAL LOSS IN ANY WAY CONNECTED WITH THE PRODUCTS, WHETHER SUCH CLAIM IS BASED ON CONTRACT, WARRANTY, NEGLIGENCE, OR STRICT LIABILITY.

In no event shall the responsibility of OMRON for any act exceed the individual price of the product on which liability is asserted.

IN NO EVENT SHALL OMRON BE RESPONSIBLE FOR WARRANTY, REPAIR, OR OTHER CLAIMS REGARDING THE PRODUCTS UNLESS OMRON'S ANALYSIS CONFIRMS THAT THE PRODUCTS WERE PROPERLY HANDLED, STORED, INSTALLED, AND MAINTAINED AND NOT SUBJECT TO CONTAMINATION, ABUSE, MISUSE, OR INAPPROPRIATE MODIFICATION OR REPAIR.

Application Considerations

SUITABILITY FOR USE

OMRON shall not be responsible for conformity with any standards, codes, or regulations that apply to the combination of products in the customer's application or use of the products.

Take all necessary steps to determine the suitability of the product for the systems, machines, and equipment with which it will be used.

Know and observe all prohibitions of use applicable to this product.

NEVER USE THE PRODUCTS FOR AN APPLICATION INVOLVING SERIOUS RISK TO LIFE OR PROPERTY WITHOUT ENSURING THAT THE SYSTEM AS A WHOLE HAS BEEN DESIGNED TO ADDRESS THE RISKS, AND THAT THE OMRON PRODUCTS ARE PROPERLY RATED AND INSTALLED FOR THE INTENDED USE WITHIN THE OVERALL EQUIPMENT OR SYSTEM.

Disclaimers

PERFORMANCE DATA

Performance data given in this catalog is provided as a guide for the user in determining suitability and does not constitute a warranty. It may represent the result of OMRON's test conditions, and the users must correlate it to actual application requirements. Actual performance is subject to the OMRON *Warranty and Limitations of Liability*.

CHANGE IN SPECIFICATIONS

Product specifications and accessories may be changed at any time based on improvements and other reasons. Consult with your OMRON representative at any time to confirm actual specifications of purchased product.

DIMENSIONS AND WEIGHTS

Dimensions and weights are nominal and are not to be used for manufacturing purposes, even when tolerances are shown.

ALL DIMENSIONS SHOWN ARE IN MILLIMETERS.

To convert millimeters into inches, multiply by 0.03937. To convert grams into ounces, multiply by 0.03527.

Note: Do not use this document to operate the Unit.

OMRON Corporation Industrial Automation Company

Kyoto, JAPAN

Contact : www.ia.omron.com

Regional Headquarters

OMRON EUROPE B.V.

Wegalaan 67-69, 2132 JD Hoofddorp
The Netherlands
Tel: (31) 2356-81-300 Fax: (31) 2356-81-388

OMRON ASIA PACIFIC PTE. LTD.
438B Alexandra Road, #08-01/02 Alexandra
Technopark, Singapore 119968
Tel: (65) 6835-3011 Fax: (65) 6835-3011

OMRON ELECTRONICS LLC

2895 Greenspoint Parkway, Suite 200
Hoffman Estates, IL 60169 U.S.A.
Tel: (1) 847-843-7900 Fax: (1) 847-843-7787

OMRON (CHINA) CO., LTD.

Room 2211, Bank of China Tower,
200 Yin Cheng Zhong Road,
PuDong New Area, Shanghai, 200120, China
Tel: (86) 21-6023-0333 Fax: (86) 21-5037-2388

Authorized Distributor:

©OMRON Corporation 2010-2023 All Rights Reserved.
In the interest of product improvement,
specifications are subject to change without notice.

CSM_2_1

Cat. No. L120-E1-02 0623 (0910)