

Sustainable control panel enable to reduce enviromental impact



For building green control panels

Natural disasters caused by global warming and climate change are become global social issue, that drives over 150 countries and regions worldwide to take action toward decarbonization. Our goal is to reduce greenhouse gas (GHG) emissions toward half by through new ways of building control panels, that key figure of the manufacturing site.



Process

Realize greatly reduces design/ manufacturing work

Innovation for design, building Process

Further Evolution for Panels

Panel

Realize compact & highly reliable control panels

Building sustainable control panels

Creating green control panels

Simple & Easy People

Green

Reducing GHG emission of control panels to achieve carbon neutrality

People

Provide reliable and comfortable manufacturing for all people who deal with control panels



Integrating green perspectives into Value Design

Value Design for Panel (Value Design) is the common concept shared across OMRON's in-panel product specifications to deliver new value to your control panels.

This Value Design also integrate environment consideration concept that enable earth and user-friendly control panel building.



- 1 Unified height & slim size*¹
- 2 Side-by-side mounting at (55°C) ambient temperature*²
- 3 Unique Push-In Plus technology*¹
- 4 Front-in and front-release wiring
- 5 eCAD library
- 6 Certification for CE, UL, and CSA
- 7 **Green features that save energy and resources*³**

CFP of control panel (total GHG emissions)*⁴

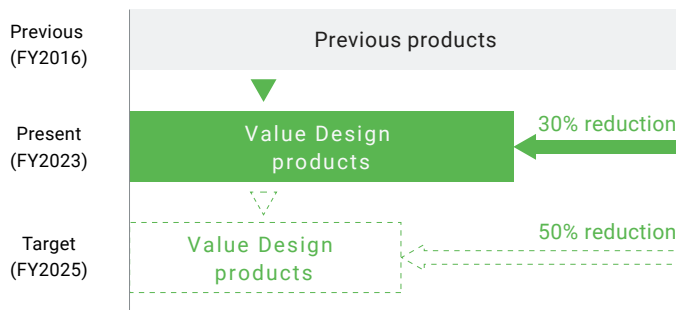

*1. Expect for some products
 *2. Side-by-side mounting is possible in the same series
 *3. Greener design compared to previous (2016) products
 *4. CFP (carbon footprint) of control panel is a calculation result of referring the life cycle assessment method that based on international standards ISO14067 which define CO₂ quantitative conversion of the environmental burden at every stage, from manufacturing, transportation, use, and disposal of the control panel (product). According to OMRON investigation in May 2023.

Extensive lineup of products for building sustainable control panels

DIN Track Terminal Blocks



Magnetic Contactors

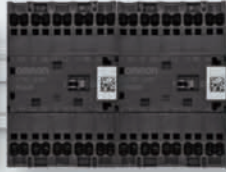

Ultra-Compact Interface Wiring System



Common Terminal Blocks



Switch mode power supplies / Related equipment



I/O Relay Terminals



Timers



Motor Protective Relays



Power Monitors



Wireless Pushbutton Switches



Condition Monitoring Devices



Temperature Controllers



Switch mode power supplies / Related equipment



Products that especially contribute to reduce environmental impact

The below products reduce GHG emissions by over 50% compared to previous (2016) products through power-saving, resource-saving, and reducing waste (according to OMRON investigation in March 2023)

Switch Mode Power Supplies (Three-phase)



Switch Mode Power Supplies (Single-phase)



Slim I/O Relays

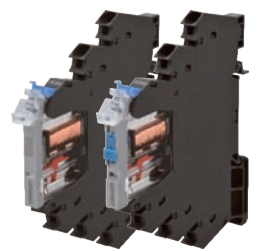

Relays, Solid-state Relays



Uninterruptible Power Supplies

Machine Automation Controllers

Safety Relays



Manual Motor Starters

Power Monitors

Pushbutton Switches

Power Monitors

Temperature Controllers



Ultra-Compact Interface Wiring System

DC Electronic Circuit Protectors

Motor Protective Relays/ Timers

Temperature Controllers









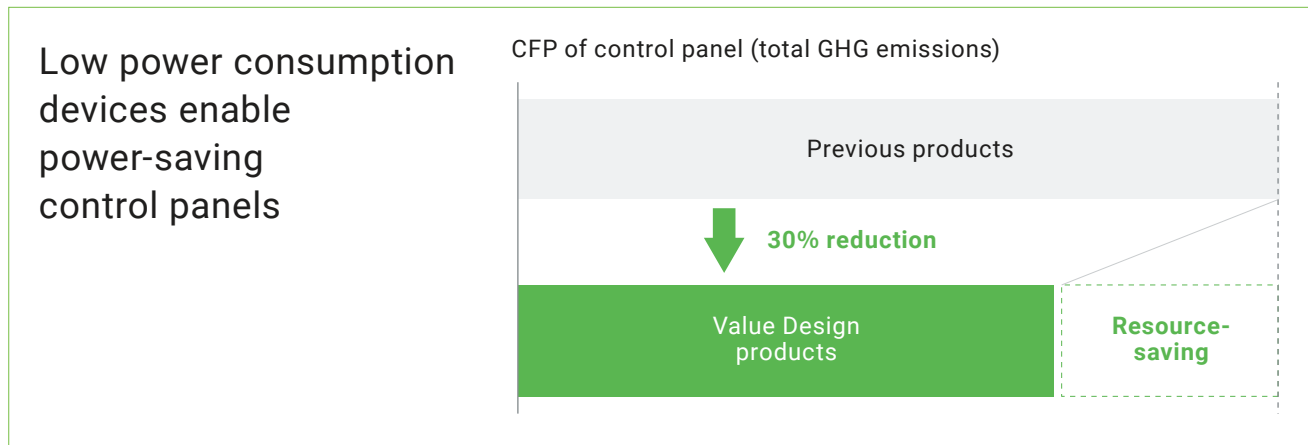



For building green control panels

Reducing GHG emissions of control panels

Our low power consumption devices allow you to easily build power-saving control panels, without compromising design philosophy.



Reduce control panel power consumption by replacing devices

BEFORE	Maximum power consumption	Value Design for Panel	Maximum power consumption	Reduction
	S8FS-G (600 W × 3 units) 228 W		S8VK-W (2 kW type) 99 W	57% reduction
	S8VS (240W) 33 W		S8VK-S (240W) 18 W	44% reduction
	E5CN 7.5 W		E5CC 6.5 W	13% reduction
	H3DK-M 1.1 W		H3DT-N 0.2 W	78% reduction
	K8AK-PH 4.1 W		K8DT-PH 2.6 W	37% reduction

Reducing power consumption by reviewing specifications

Review of power supply specifications

Specification change point:
Circuit change associated with switching from transformer + single phase to three phase

60% reduction in power consumption



Transformer



S8VS
Switch Mode Power Supplies
(Single-phase)

▶



S8VK-WA
Switch Mode Power Supplies
(Three-phase)

Optimization of endurance specifications

Specification change point: Relay endurance:
500,000 operations min. → 100,000 operations min. (at 5A)
(Switchable when the required endurance is 100,000 times or less.)

Specification change point: Relay endurance:
250,000 operations min. → 70,000 operations min. (at 5A)
(Switchable when the required current is 6A or less and endurance is 70,000 times or less)

41% reduction in power consumption



MY2

▶



G2R-2-S

43% reduction in power consumption



G2R-1-S

▶



G2RV-ST

Power consumption can be easily reduced by reviewing to the latest model with reduced power consumption and reviewing the most suitable model to optimize the application.

Introduction of Technology for Realizing Low Power Consumption Device

High-density/high-efficiency design that reduces power consumption of power supplies

Switching loss reduced through soft switching (minimizing intersection of voltage and current waveforms)

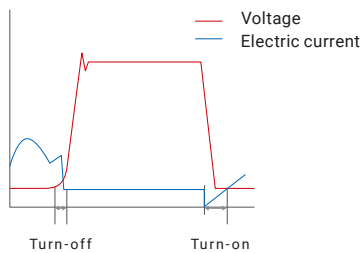

Noise filtering optimized through thermal analysis

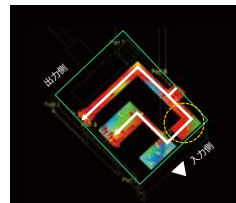

Unique low power consumption display method that reduces temperature controller power consumption

BEFORE

Direct lit



Number of lit LEDs: 13



AFTER

Edge lit



Number of lit LEDs: 3



For building green control panels

Reducing GHG emissions of control panels

Compact, slim devices with unified height and devices with reduced wiring allow for resource-saving purchased components for control panels.

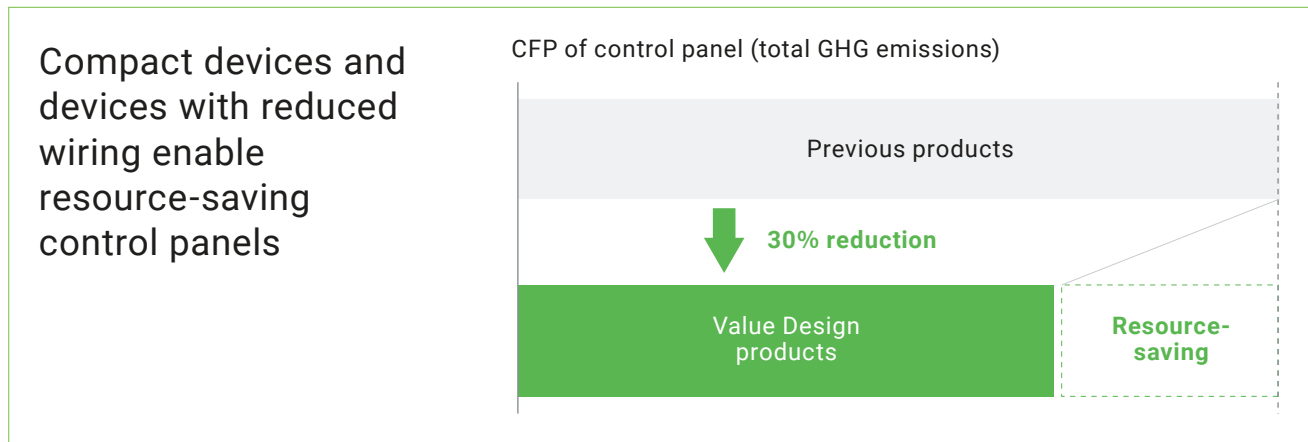

Miniaturization of equipment and reduced wiring enable resource conservation of control panel materials

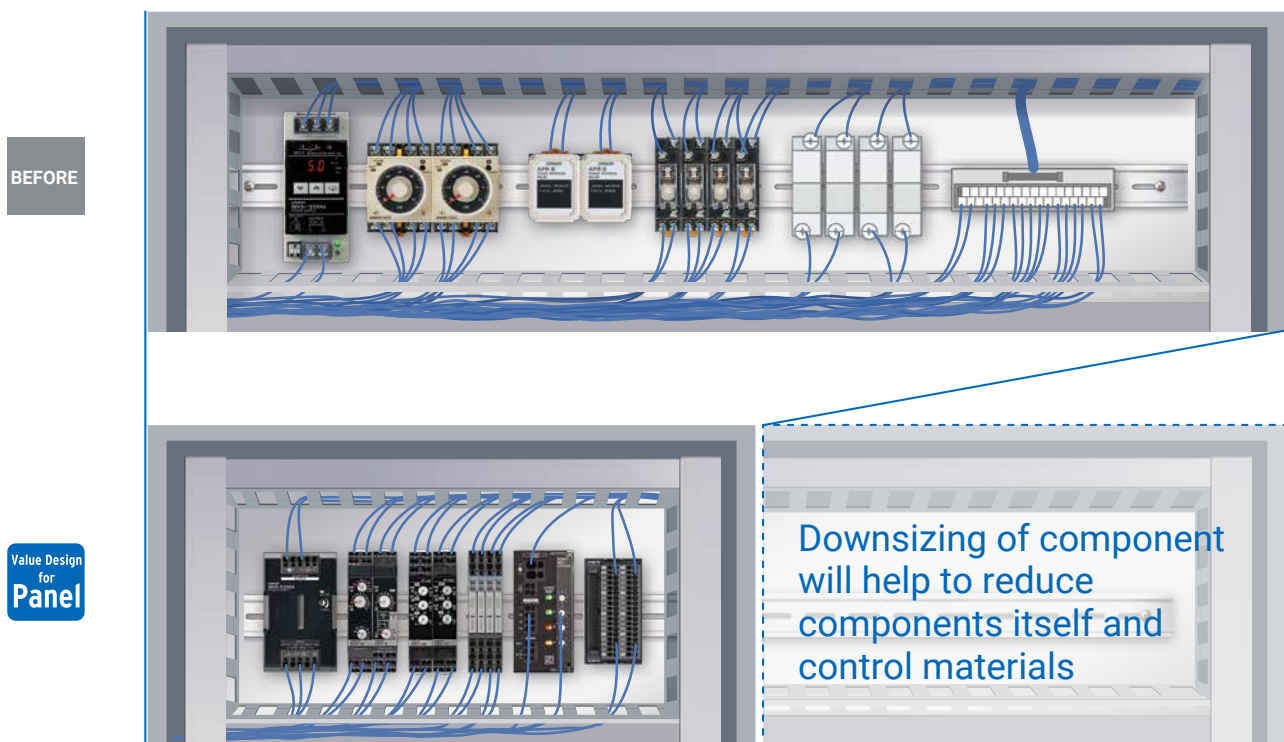

Control components for which resource-saving can be applied

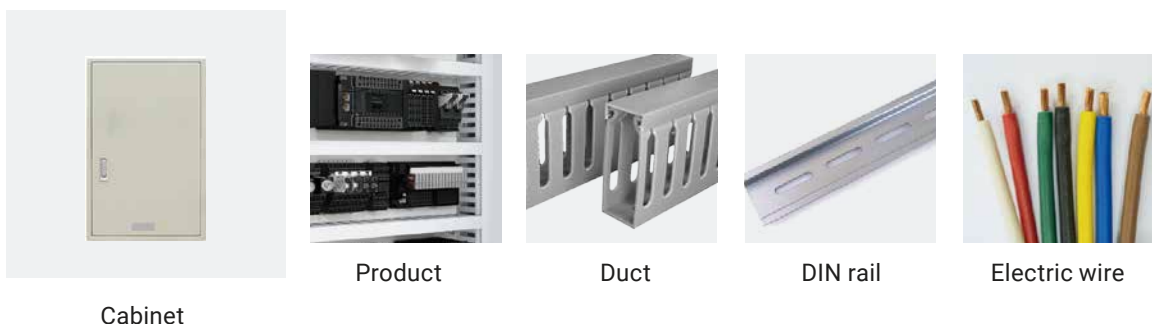

Additional components lighter weight contribute to material saving of control panels

BEFORE

Component	Weight
S8FS-G (600 W 3 units)	4,620 g
XW2R	113 g
G7TC	728 g
S8VS	1,600 g
E5CN	190 g
H3DK-M	145 g
K8AK-PH	171 g



Value Design for Panel

Component	Weight	Reduction
S8VK-W (2 kW type)	3,600 g	22% reduction
XW2K	83 g	27% reduction
G70V	408 g	44% reduction
S8VK-S	945 g	41% reduction
E5CC	157 g	17% reduction
H3DT-N	122 g	16% reduction
K8DT	118 g	31% reduction

For building green control panels

Reducing GHG emissions of control panels

OMRON helps you measure how effectively Value Design products actually reduce control panel power consumption.

Power monitors enable easy assessment of power-saving effect



Power monitors enable visualization of power consumption reduction effect on per-control panel basis

BEFORE

Assessment of power consumption reduction effect requires massive effort because each control panel has different device configuration and therefore has to be measured separately

Measurements taken per model and then totaled



	200 W
	+
150 W	Timer
+	+
Contactor	Relay
+	+
Relay	Switch Mode Power Supplies
+	
Switch Mode Power Supplies	
Control panel A	Control panel B



Power monitor constantly visualizes power consumption, with no need for separate measurements

Continuous measurement at once without individual measurement



Control panel A

Control panel B

Power Monitors (KM-N2-FLK)

Further Evolution for Panels

Saving Space and More-advanced Control Panels

Unified size and side-by-side mounting help delivering more compact control panels with additional functionality.

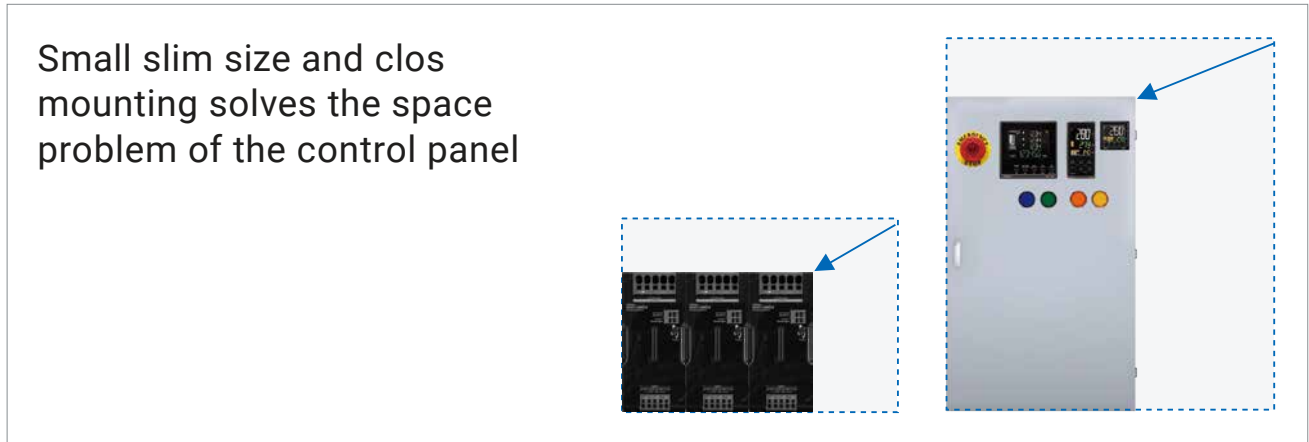

Slim + Side-by-side mounting technology save space, and make more advanced Control Panels

You can add a new function, at the re-engineering stage for improving product quality and securing safety of the production line.

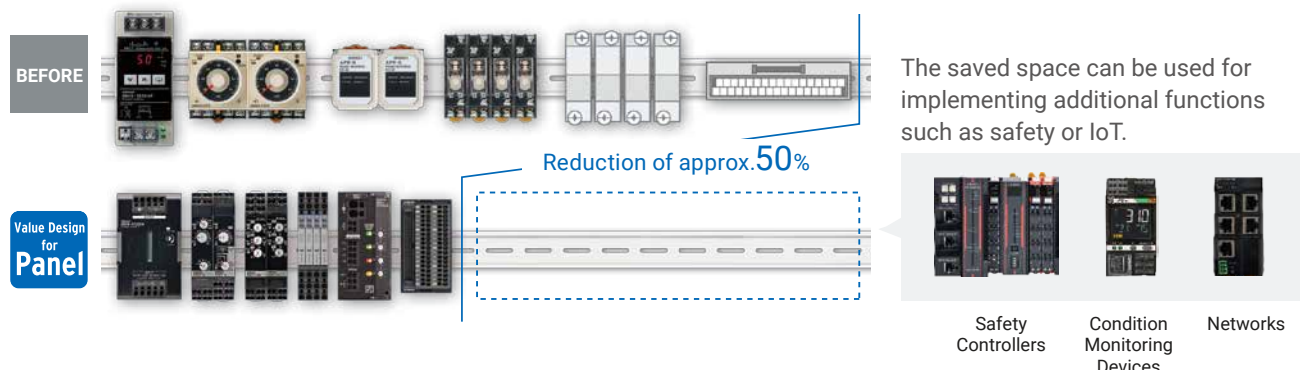

Unified height reduces dead space and downsizes control panels

When newly designing, you can decrease the height of a control panel to secure a wide view of a whole production line for improved safety.

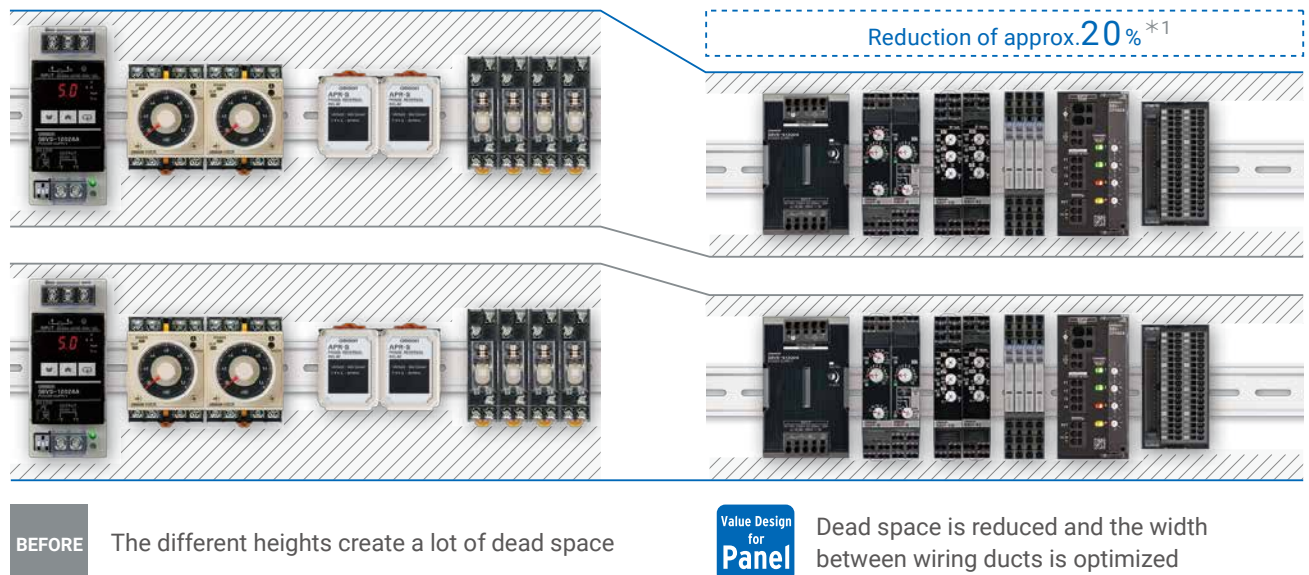

Simple & Easy People Reducing Wiring Work

Push-In Plus technology and Front-in / Front-release Wiring allow wiring work easier and speedier.

Push-in Plus technology solves control panel wiring issues

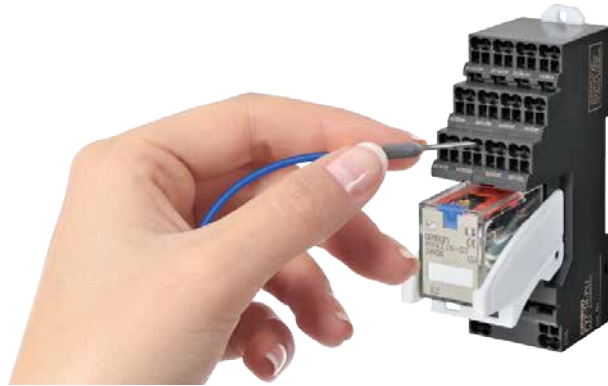

Front-in Wiring improves workability and safety without interference of wires even in the narrow space among devices

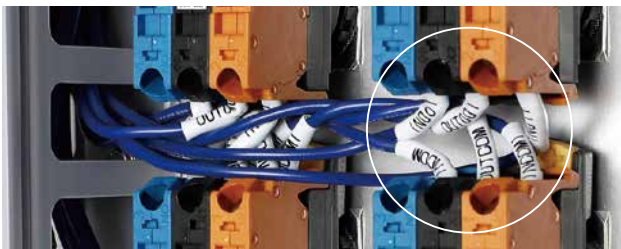

BEFORE Hard wiring in the narrow space by the interference of wires due to the screw terminals requiring wiring in vertical direction

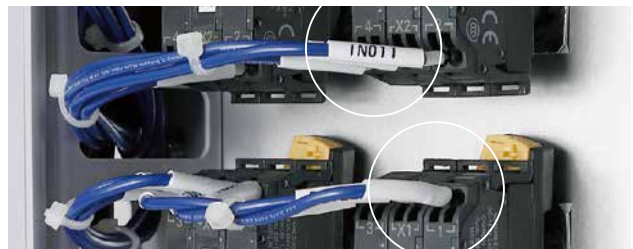

Value Design for Panel No interference of wiring helps improve workability and safety

Improved wiring workability by unified I/O terminal positions on the top and bottom

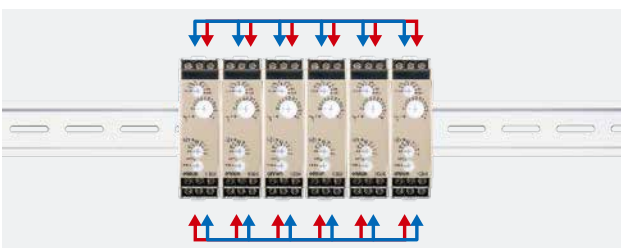

BEFORE Hard wiring due to mixed I/O terminals located on the top and bottom

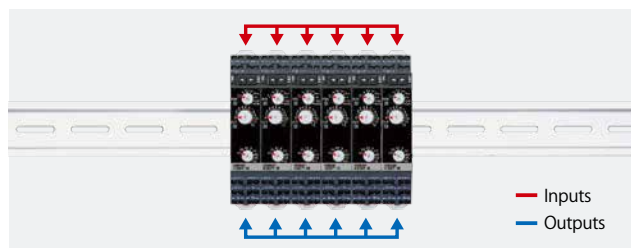

Value Design for Panel Unified method so that inputs are on the top and output

Easy wiring with both hands for stranded wires with holding screwdriver

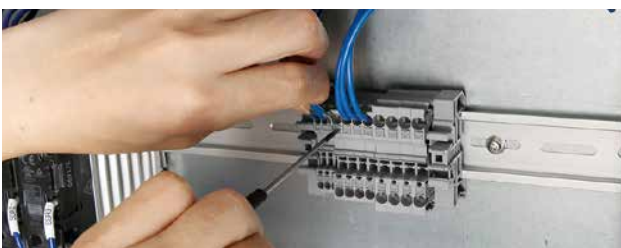

BEFORE One hand wiring with the other hand holding the screwdriver



Stranded wires, single wires, and Ferrules are supported



Value Design for Panel Wiring with both hands, because the screwdriver is held in the release hole

Shortening Lead Time for Control Panel Building

Compatible with eCAD and worldwide safety standards, accelerating an entire process of control panel manufacturing

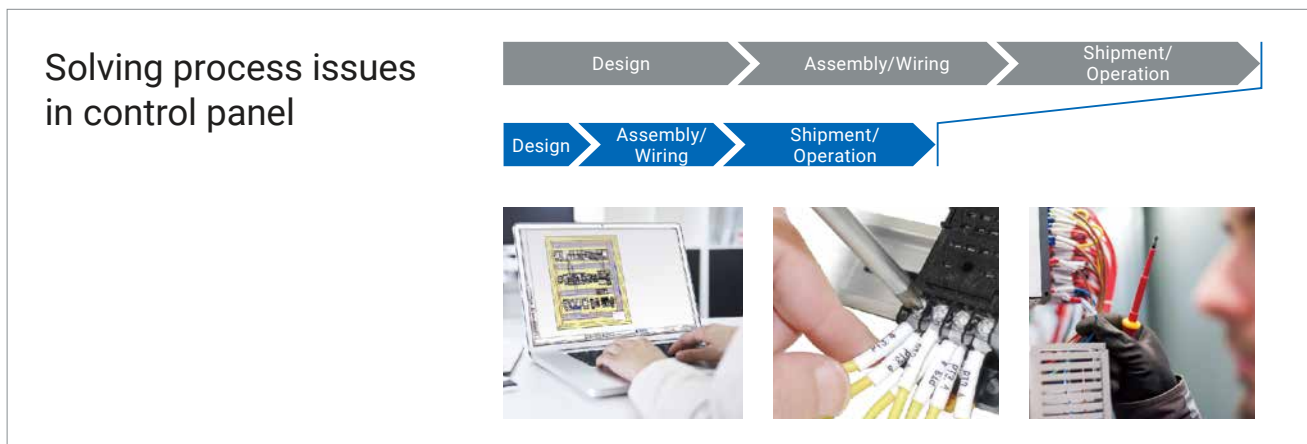

Design eCAD library provided for all models greatly reduces design work

OMRON provides the libraries for over 48,000 models*2, highest in the industry, to achieve the great reduction of works for electrical design drawing and data creation.

Up to 50%*1

eCAD Partners

By cooperating with various partners, we offer you more choices for your eCAD solutions.

E3.series is a product name of Zuken Inc. for their Electrical and Control Cable Design Solution. EPLAN is a registered trademark of EPLAN Software & Service GmbH & Co. KG.



Zuken Inc. EPLAN

*1. In the case of ZUKEN E3 series

*2. In the case of EPLAN, based on

OMRON's investigation as of 2020 December

Assembly/Wiring Push-In Plus technology requires only a single step, greatly reducing wiring work

Reduction of approx. 60%*3



1. Remove the screw
2. Connect with the terminal
3. Tighten the screw
4. Put a check mark
5. Retighten the screw



1. Insert the terminal

BEFORE

A lot of steps are required to complete wiring for the screw terminal...

Value Design for Panel

Push-In Plus technology completes by a single step

*3. Information for Push-In Plus and Screw Terminal Blocks is based on OMRON's actual measurement data

Shipment/Operation No need for retightening, even when vibration is applied on terminals

The pressure of the clamp spring holds the ferrule or wire securely with Push-In Plus technology, eliminating worries about screws loosening or disconnection due to vibration.



BEFORE

The screw is loosened and dropped by vibration

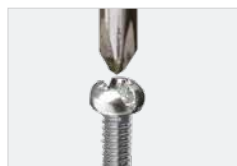

Retightening is needed before export and shipment







Value Design for Panel

No drop-off or retightening of screws





Selection Guide

Available in a wide range from input to control, output, and safety.

>P.16-18

Smart Power Supply S8AS2		Switch Mode Power Supplies (Single-phase) S8VK-S	
Switch Mode Power Supplies (Single-phase/With displays and communications) S8VK-X		Noise Filters S8V-NF	
Switch Mode Power Supplies (Three-phase/single-phase) S8VK-WA (Three-phase) S8VK-WB		DC Electronic Circuit Protectors S8V-CP	

>P.19-20

Magnetic Contactors(Contactor) J7KC	
Manual Motor Starters J7MC	
Thermal Overload Relays J7TC	
Auxiliary Relay (Contactor Relays) J7KCA	

>P.25

Solid-state Timers H3DT	
----------------------------	---



>P.26

Motor Protective Relays K8DT	
---------------------------------	---

>P.27

DIN Track Terminal Blocks XW5T	
-----------------------------------	---

>P.28

Ultra-Compact Interface Wiring System XW2K	
Ultra-Compact Common Terminal Blocks XW2K-COM	



>P.27

Common Terminal Blocks
XW6T



>P.31

Uninterruptible Power Supplies
S8BA



>P.30

Power Monitors
KM-PM/KM-N2/KM-N3



>P.32-33

Temperature Controllers
E5CC-B/E5EC-B/E5DC-B



>P.29

Solid State Relays for Heater
G3PJ



>P.31

Pushbutton Switches
Emergency Stop Pushbutton Switches
A22N-P/A22NE-P



>P.21-24

Sockets with Push-In Plus
technology
PYF-□□-PU/PTF-□□-PU
P2RF-□□-PU/P7SA-PU



Slim I/O Relays
G2RV-ST



Slim I/O Solid State Relays
G3RV-ST



Terminal Relays
G6D-F4PU/G3DZ-F4PU



I/O Relay Terminals
G70V



Single-phase input type (With Indication and Electronic Circuit Protectors) S8AS2



- An all-in-one solution combining power, protection, and connectivity
- Outstanding tripping performance deliver enhanced stability to your power systems.

Input voltage	Output voltage	Capacity	Maximum cutoff output current (per branch)	Total output current	Number of output branches	Parameter settings	Model	Size W×H×D (mm)
100 to 240 VAC	24 V	240 W	3.8 A	10 A	6 branch outputs	Changeable	S8AS2-24024-06S	92×115×125.4
						Not changeable	S8AS2-24024-06SN	92×115×125.4
		480 W		20 A	8 branch outputs	Changeable	S8AS2-48024-08S	115×115×125.4
						Not changeable	S8AS2-48024-08SN	115×115×125.4

Single-phase input type S8VK-S

Cat. No. T205



- Compact and side-by-side mounting, contributing to space saving.
- Coated PCBs for Better Resistance to Environment

Rated input voltage	Rated output voltage	Power rating	Rated output current	Maximum boost current	Model	Size W×H×D (mm)
100 to 240 VAC (allowable range: 85 to 264VAC or 90 to 350 VDC)	24 VDC	30 W	1.3 A	1.56 A	S8VK-S03024	32×90×86
		60 W	2.5 A	3 A	S8VK-S06024	32×90×86
		120 W	5 A	6 A	S8VK-S12024	55×90×86
		240 W	10 A	15 A	S8VK-S24024	38×124×117.8
		480 W	20 A	30 A	S8VK-S48024	60×124×117.8

Single-phase input type (With Indication and communication) S8VK-X

Cat. No. T210

- Product replacement time, output voltage, output current, and more are acquired on the network and can be managed all at once.
- Product status can be checked on-site using the indication monitor.



With Indication Monitor

Rated input voltage	Rated output voltage	Power rating	Rated output current	Maximum boost current	Model	Size W×H×D (mm)
100 to 240 VAC (allowable range: 85 to 264 VAC, 90 to 350 VDC)	24 VDC	90 W	3.75 A	—	S8VK-X09024A-EIP	55×90×86
		120 W	5 A	6 A	S8VK-X12024A-EIP	55×90×86
		240 W	10 A	15 A	S8VK-X24024A-EIP	38×124×117
		480 W	20 A	30 A	S8VK-X48024A-EIP	60×124×117

Without Indication Monitor

Rated input voltage	Rated output voltage	Power rating	Rated output current	Maximum boost current	Model	Size W×H×D (mm)
100 to 240 VAC (allowable range: 85 to 264 VAC, 90 to 350 VDC)	5 VDC	30 W	5 A *1	6 A	S8VK-X03005-EIP	40×90×86
	12 VDC	60 W	4.5 A *2	5.4 A	S8VK-X06012-EIP	40×90×86
			2.5 A	3 A	S8VK-X06024-EIP	40×90×86
		90 W	3.75 A	—	S8VK-X09024-EIP	55×90×86
		120 W	5 A	6 A	S8VK-X12024-EIP	55×90×86
		240 W	10 A	15 A	S8VK-X24024-EIP	38×124×117
		480 W	20 A	30 A	S8VK-X48024-EIP	60×124×117

*1. Output power is 25 W at rated output current.

*2. Output power is 54 W at rated output current.

For detailed information such as formats and options other than those listed, please refer to the catalog data sheet of each product. D (depth) of the external dimension is the length from the front to the DIN rail.

Three-phase input type S8VK-W

Cat. No. T219

- Three-phase Input Power Supplies harmonized with Value design for Panel concept.
- With a line-up that includes two model types, 200 to 240 V input and 380 to 480 V input.



Rated input voltage	Rated output voltage	Power rating	Rated output current	Maximum boost current	Model	Size W×H×D (mm)
Three-phase / single-phase 200 to 240 VAC(Allowable range:Three-phase / single-phase170 to 264 VAC, 240 to 350 VDC)	24 VDC	240 W	10 A	15 A	S8VK-WA24024	55×124×117
		480 W	20 A	30 A	S8VK-WA48024	65×124×117
		960 W	40 A	60 A	S8VK-WA96024	118×124×117
Three-phase / single-phase 200 to 240 VAC(Allowable range: Three-phase / singlephase 170 to 264 VAC, 240 to 384 VAC)	24 VDC	2000 W	85 A	127.5 A	S8VK-WA20224	190×124×129
	48 VDC		45 A	67.5 A	S8VK-WA20248	190×124×129

Rated input voltage	Rated output voltage	Power rating	Rated output current	Maximum boost current	Model	Size W×H×D (mm)
Three-phase / two-phase 380 to 480 VAC (Allowable range: Three-phase / two-phase 320 to 576 VAC, 450 to 810 VDC)	24 VDC	240 W	10 A	15 A	S8VK-WB24024	55×124×117
		480 W	20 A	30 A	S8VK-WB48024	65×124×117
		960 W	40 A	60 A	S8VK-WB96024	118×124×117
	48 VDC	240 W	5 A	7.5 A	S8VK-WB24048	55×124×117
		480 W	10 A	15 A	S8VK-WB48048	65×124×117
		960 W	20 A	30 A	S8VK-WB96048	118×124×117

Noise Filters S8V-NF

Cat. No. T212

- Featuring a Slim Design that Saves Space
- Push-In Connections for Safe and Easy Wiring



Rated input voltage	Rated output voltage	Model	Size W×H×D (mm)
250 VAC 250 VDC	3 A	S8V-NFS203	32×90×86
	6 A	S8V-NFS206	

DC Electronic Circuit Protectors S8V-CP

Cat. No. T226

- Simplified safety design of DC circuits
- Saves space even with multi-channel



Number of Outputs	UL Class 2 output	Rated output voltage	Model	Size W×H×D (mm)
4 ch	NO	24 VDC	S8V-CP0424	44.8×90×90.8
	YES		S8V-CP0424S	
8 ch	NO		S8V-CP0824	42×127×118.1

Magnetic Contactors (Contactor) J7KC

Cat. No. J230

- Motor Control up to 2.2 kW (200 to 240 VAC) ,5.5 kW (380 to 440 VAC), AC-3 class compatible, ideal for small pumps such as conveyors and coolant pumps.
- Magnetic Contactor with Mirror contacts according to EN 60947-4-1 in safety applications, whose switching function is controlled by a safety-related system.



Product Type	Operation	Coil rating	Auxiliary contact	Model	Size W×H×D (mm)
Magnetic contactor	AC-operated	24 VAC	SPST-1NO	J7KC-12-10 AC24	45×67.5×49
			SPST-1NC	J7KC-12-01 AC24	
		100 VAC	SPST-1NO	J7KC-12-10 AC100	
			SPST-1NC	J7KC-12-01 AC100	
		200 VAC	SPST-1NO	J7KC-12-10 AC200	
			SPST-1NC	J7KC-12-01 AC200	
		230 VAC	SPST-1NO	J7KC-12-10 AC230	
			SPST-1NC	J7KC-12-01 AC230	
(With built-in surge absorption unit)	DC-operated	24 VDC	SPST-1NO	J7KC-12-10 DC24	
			SPST-1NC	J7KC-12-01 DC24	
Reversing magnetic contactor	AC-operated	200 VAC	SPST-2NO	J7KCR-12-10 AC200	90.5×77.5×78
			SPST-2NC	J7KCR-12-01 AC200	
	DC-operated (With built-in surge absorption unit)	24 VDC	SPST-2NO	J7KCR-12-10 DC24	
			SPST-2NC	J7KCR-12-01 DC24	

Auxiliary contact unit

Number of poles	Auxiliary contact	Model
2 Poles	2PST-1NO 1NC	J73KC-AM-11
	4PST-4NO	J73KC-AM-40
4 Poles	4PST-2NO 2NC	J73KC-AM-22
	4PST-4NC	J73KC-AM-04

Auxiliary Relays(Contactor Relay) J7KCA

Cat. No. J232

- Same shape as J7KC magnetic contactors Ideal for standardizing panel design



Coil rating	Contact configuration	Model	Size W×H×D (mm)
24 VDC	4PST-4NO	J7KCA-40 DC24	45×67.5×49
	4PST-3NO 1NC	J7KCA-31 DC24	
	4PST-2NO 2NC	J7KCA-22 DC24	

For detailed information such as formats and options other than those listed, please refer to the catalog data sheet of each product.

Manual Motor Starters J7MC

Cat. No. T212



- MPCB system, protection from Overload, Phase failure and Short Circuit
- In combination with magnetic contactor model J7KC, it is ideal for control of motors to AC-3 class, 2.2 kW (200 to 240 VAC) *1 or 5.5 kW (380 to 440 VAC).

*1. Based on JIS C 8201-4-1

3-phase standard motor capacity and full load current (reference values)*2 200 to 240 VAC		Current setting range Rated operating current [A]	Rocker switch (standard type)		Rotary switch (high-performance type)		Magnetic contactor model
Capacity [kW]	Current [A]		Model	Size W×H×D (mm)	Model	Size W×H×D (mm)	
—	—	0.1-0.16	J7MC-3P-E16	45×130×74.7	J7MC-3R-E16	45×130×94.7	J7KC-12
0.03	0.24	0.16-0.25	J7MC-3P-E25		J7MC-3R-E25		
0.06	0.37	0.25-0.4	J7MC-3P-E4		J7MC-3R-E4		
—	—	0.4-0.63	J7MC-3P-E63		J7MC-3R-E63		
0.1	0.68	0.63-1	J7MC-3P-1		J7MC-3R-1		
0.2	1.3	1-1.6	J7MC-3P-1E6		J7MC-3R-1E6		
0.4	2.3	1.6-2.5	J7MC-3P-2E5		J7MC-3R-2E5		
0.75	3.5	2.5-4	J7MC-3P-4		J7MC-3R-4		
—	—	4-6.3	J7MC-3P-6		J7MC-3R-6		
1.5	6.9	6.3-10	J7MC-3P-10		J7MC-3R-10		
2.2	9.5						
2.2	9.5						

*2. The 3-phase motor full load current is a reference value. When applying, check the full load current of the motor you will use.

Thermal Overload Relays J7TC

Cat. No. T212



- One-touch Installation with magnetic contactor J7KC to configure a magnetic starter
- Motor Protection from Overload and Phase -loss by Combination with J7KC for up to 2.2 kW (240 VAC) ,5.5 kW (440 VAC).

*. Based on JIS C 8201-4-1

3-phase standard motor capacity and full load current (reference values)			Setting current range [A]	Model	Size W×H×D (mm)	Magnetic contactor model
Main circuit voltage	Capacity P(kW)	Current Ie (A)				
4P AC200V 50Hz	0.1	0.68	0.48 - 0.72	J7TC-01-E72	45×79.5×63.5	J7KC-12
	0.2	1.3	0.95 - 1.45	J7TC-01-1E4		
	0.4	2.3	1.7 - 2.6	J7TC-01-2E6		
	0.75	3.8	2.8 - 4.2	J7TC-01-4E2		
	1.5	7	5 - 7.5	J7TC-01-7E5		
	2.2	9.8	7 - 10.5	J7TC-01-10		

Note: The 3-phase motor full load current is a reference value. When applying, check the full load current of the motor you will use.

Sockets with Push-In Plus technology

PYF-□□-PU/PTF-□□-PU/

P2RF-□□-PU/P7SA-PU

Cat. No. J212, J120





• Sockets with Push-In Plus technology to Save Work Added to Series for MY, LY, G2R-S Relays and G7SA Relays with Forcibly Guided Contacts









Applicable model (typical example)			No. of poles	Model	Size W×H×D (mm)
General Purpose Relays	MY Seires	MY2	2	PYF-08-PU	31×90×71.4
		MY4	4	PYF-14-PU	
	LY Seires	LY2	2	PTF-08-PU	24.8×90×70.1
		LY2-CR	2	PTF-08-PU-L	24.8×90×52.1
		LY4	4	PTF-14-PU-L	43.4×90×52.1
	G3H Seires	G3H	1	PTF-08-PU	24.8×90×70.1
		G3HD			
	G9H Seires	G9H			
	G2R-□-S Seires	G2R-1-S	1	P2RF-05-PU	15.5×90×57
G2R-2-S		2	P2RF-08-PU		
Timers	H3Y, H3YN Seires	H3Y(N)-2-B	2	PYF-08-PU-L	31×90×57
		H3Y(N)-4-B	4	PYF-14-PU-L	
	H3RN Seires	H3RN-1-B	1	P2RF-05-PU	15.5×90×57
		H3RN-2-B	2	P2RF-08-PU	
Liquid Leakage Sensors	K7L Seires	K7L-□B	2		
Relays with Forcibly Guided Contacts	G7SA Seires	G7SA	4	P7SA-10F-ND-PU DC24	22.5×100×61
			6	P7SA-14F-ND-PU DC24	27.7×100×61

For detailed information such as formats and options other than those listed, please refer to the catalog data sheet of each product.

PYF-PU-Applicable Models

Applicable models	General Purpose Relays		SSRs	Timers	
	MY2	MY4	G3F/G3FD	H3Y(N)-2-B	H3Y(N)-4-B
No. of poles	2	4	1	2	4
Socket model	PYF-08-PU	PYF-14-PU	PYF-08-PU	PYF-08-PU-L* ¹	PYF-14-PU-L* ¹
Appearance					



PTF-PU-Applicable Models

Applicable models	General Purpose Relays			SSRs	Temperature Controllers	
	LY2	LY2-CR	LY4	G3H/G3HD/G9H	E5L-A	E5L-C
No. of poles	2	2	4	1	—	—
Socket model	PTF-08-PU	PTF-08-PU-L* ¹	PTF-14-PU-L* ¹	PTF-08-PU	PTF-14-PU-L* ¹	PTF-14-PU-L* ¹
Appearance						

P2RF-PU-Applicable Models

Applicable models	General Purpose Relays		SSRs	Timers		Liquid Leakage Sensor Amplifiers
	G2R-1-S	G2R-2-S	G3R-I/O/G3RZ	H3RN-1-B	H3RN-2-B	K7L-B
No. of poles	1	2	1	1	2	—
Socket model	P2RF-05-PU	P2RF-08-PU	P2RF-05-PU	P2RF-05-PU	P2RF-08-PU	P2RF-08-PU
Appearance						

P7SA-PU-Applicable Models

Applicable models	Relays with Forcibly Guided Contacts	
	G7SA	G7SA
No. of poles	4	6
Socket model	P7SA-10F-ND-PU DC24	P7SA-14F-ND-PU DC24
Appearance		

*A release lever is not included.

Slim I/O Relays

G2RV-ST

Cat. No. J267

- Slim I/O relay with width 6.2 mm
- The test button function and mounted relay use plug-in terminals that are difficult to bend when exchanging.
- Since G2RV is a transparent case, confirming the state of the contact with the naked eye is possible, and easy to confirm abnormality on-site (installed location).



Classification	Latching lever (Test switch)	Rated input voltage	Model	Size W×H×D (mm)
Standard	No	12 VDC	G2RV-ST500 12 VDC	6.2×90×88
		24 VDC	G2RV-ST500 24 VDC	
		24 VAC/VDC	G2RV-ST500 24 VAC/VDC	
		48 VAC/VDC	G2RV-ST500 48 VAC/VDC	
		100 VAC	G2RV-ST500 100 VAC	
		200 VAC	G2RV-ST500 200 VAC	
	Yes	24 VDC	G2RV-ST501 24 VDC	
		24 VAC/VDC	G2RV-ST501 24 VAC/VDC	
Microloads	No	12 VDC	G2RV-ST500-AP 12 VDC	
		24 VDC	G2RV-ST500-AP 24 VDC	
		24 VAC/VDC	G2RV-ST500-AP 24 VAC/VDC	

Slim I/O Solid State Relays

G3RV-ST

Cat. No. J267

- Width 6.2 mm., high frequency, high-speed opening and closing SSR (solid state relay).



Applicable output load	Zero cross function	Rated input voltage	Model	Size W×H×D (mm)
DC load	—	12 VDC	G3RV-ST500-D 12 VDC	6.2×90×88
		24 VDC	G3RV-ST500-D 24 VDC	
		24 VAC/VDC	G3RV-ST500-D 24 VAC/VDC	
		100 VAC	G3RV-ST500-D 100 VAC	
		200 VAC	G3RV-ST500-D 200 VAC	
DC load (high-speed opening and closing)	—	24 VDC	G3RV-ST500-D-H 24 VDC	
		24 VAC/VDC	G3RV-ST500-D-H 24 VAC/VDC	
AC load	Yes	12 VDC	G3RV-ST500-A 12 VDC	
		24 VDC	G3RV-ST500-A 24 VDC	
		24 VAC/VDC	G3RV-ST500-A 24 VAC/VDC	
	No	12 VDC	G3RV-ST500-AL 12 VDC	
		24 VDC	G3RV-ST500-AL 24 VDC	
		24 VAC/VDC	G3RV-ST500-AL 24 VAC/VDC	

For detailed information such as formats and options other than those listed, please refer to the catalog data sheet of each product.

Terminal Relays

G6D-F4PU/G3DZ-F4PU

Cat. No. J228



- Model with Push-In Plus technology Added to Terminal Relays with Four-point Output Lineup.
- Rated 5A is achieved with optimum designs than conventional screw-type G6D-F4B (rated 3A).

Wide Variety of Application

Mounted Relay type	Contact form	Operation coil ratings	Model	Size W×H×D (mm)
Mechanical Relay	SPST x 4 (1NO x 4)	12 VDC	G6D-F4PU DC12	31×90×35
		24 VDC	G6D-F4PU DC24	
Power MOS FET relay		12 VDC	G3DZ-F4PU DC12	
		24 VDC	G3DZ-F4PU DC24	

I/O Relay Terminals

G70V

Cat. No. J215



- I/O Relay Terminals with 16 Points and Push-In Plus terminal blocks to Downsize Control Panels and Save Labor

Classification	Point	Common Line		Rated voltage	Model	Size W×H×D (mm)
		Terminal Block Side	Connector Side			
Input	16	No internal connections	NPN(- common)	24 VDC	G70V-SID16P	143×90×56
			PNP(+ common)		G70V-SID16P-1	
		16 points internally connected	NPN(- common)		G70V-SID16P-C16	
			PNP(+ common)		G70V-SID16P-1-C16	
Output		No internal connections	NPN(+ common)		G70V-SOC16P	
			PNP(- common)		G70V-SOC16P-1	
		Every 4 points internally connected at terminal block bottom row	NPN(+ common)		G70V-SOC16P-C4	
			PNP(- common)		G70V-SOC16P-1-C4	

- Width 6.2 mm., high frequency, high-speed opening and closing SSR (solid state relay).
- Realized a slim shape with a switching capacity up to 3 A (DC), and 2 A (AC)

Solid-state Timers H3DT

Cat. No. M090



- Slim Timers (17.5-mm width) with two sets of contacts: One of the slimmest Timers worldwide. *1
- Reduces power consumption (active power) by up to 60% to help reduce heat generation in control panels.*2

*1. According to OMRON investigation in February 2020.

*2. Based on OMRON comparison (excluding the H3DT-H).

Operating modes	Supply voltage	Type	Control output	Model	Size W×H×D (mm)
Eight-mode Timer	24 to 240 VAC/DC	Standard Eight-mode Timer	Contact output, DPDT (time-limit DPDT, or time-limit SPDT + instantaneous SPDT) Changed using a switch.	H3DT-N2	17.5×90×90
		Expansion Eight-mode Timer		H3DT-L2	
		Standard Eight-mode Timer		H3DT-N1	
		Expansion Eight-mode Timer		H3DT-L1	
Power ON-delay		—	Contact output, DPDT (time-limit DPDT)	H3DT-A2	
		—	Contact output, SPDT (time-limit SPDT)	H3DT-A1	
Flicker OFF Start, ON start		Twin Timer (Independent ON time and OFF time settings)	Contact output: SPDT	H3DT-F	
Star-delta		—	Contact outputs Delta circuit: SPDT, Star circuit: SPDT	H3DT-G	
Power OFF-delay	100 to 120 VAC	S Series (time range: 0.1 to 12 s)	Contact output: SPDT	H3DT-HCS	
		L Series (time range: 1.0 to 120 s)		H3DT-HCL	
	200 to 240 VAC	S Series (time range: 0.1 to 12 s)		H3DT-HDS	
		L Series (time range: 1.0 to 120 s)		H3DT-HDL	
	24 to 48 VAC/DC	S Series (time range: 0.1 to 12 s)		H3DT-HBS	
		L Series (time range: 1.0 to 120 s)		H3DT-HBL	

For detailed information such as formats and options other than those listed, please refer to the catalog data sheet of each product.

Measuring and Monitoring Relays K8DT



- Models with transistor outputs available for long-term contact reliability.
- Control panel downsizing and reduced wiring; flexible layout with a 17.5-mm width
- Push-In Plus terminal blocks for easy wiring

Measuring and Monitoring object		Input	Output	Alarm operation	Function	Series name*1	Size W×H×D (mm)
Motor protection	Single phase	Current	One SPDT relay output or One Transistor	Upper or lower limit (switched)	Single-phase Undercurrent or Single-phase Overcurrent	K8DT-AS Cat. No. N201	17.5×90×90
				Upper and lower limits (redundant operation)	Single-phase Undercurrent Single-phase Overcurrent	K8DT-AW Cat. No. N202	
		Voltage		Upper or lower limit (switched)	Single-phase Undervoltage or Single-phase Overvoltage	K8DT-VS Cat. No. N203	
				Upper and lower limits (redundant operation)	Single-phase Undervoltage Single-phase Overvoltage	K8DT-VW Cat. No. N204	
	Three phase	Voltage		Fixed	Phase sequence、 Phase loss	K8DT-PH Cat. No. N206	
				Upper and lower limits	Phase sequence、 Phase loss、 Three-phase Undervoltage、 Three-phase Overvoltage	K8DT-PM Cat. No. N207	
					Phase sequence、 Phase loss、 Three-phase Undervoltage、 Three-phase Overvoltage、 Three-phase Asymmetry	K8DT-PZ Cat. No. N208	
				Upper or lower limit (switched)	Temperature Monitoring	K8DT-TH Cat. No. N209	
Temperature monitoring	Thermocouple or platinum resistance thermometer						
Water level control	Electrode		Water supply or discharge (switched)	Water level control	K8DT-LS Cat. No. N205		

*1.For detailed format specifications and inventory information, please refer to Catalog or data sheet.

DIN Track Terminal Blocks

XW5T

Cat. No. G124



- Push-in Plus Terminal Blocks to Downsize Control Panels and Save Work

Common specifications				Feed Through Terminal blocks (Dark gray)	Grounding Terminal blocks (Green / Yellow)	Size W×H×D (mm)
Product Type	Applicable wire sizes*1	Number of levels	Wiring	Model	Model	
Standard terminals	0.08 mm ² to 1.5 mm ² AWG28 to AWG16	1	1:1	XW5T-P1.5-1.1-1	XW5G-P1.5-1.1-1	3.5×45×30.5
	0.14 mm ² to 2.5 mm ² AWG26 to AWG14			XW5T-P2.5-1.1-1	XW5G-P2.5-1.1-1	5.2×48.8×35.3
	0.2 mm ² to 4.0 mm ² AWG24 to AWG12			XW5T-P4.0-1.1-1	XW5G-P4.0-1.1-1	6.2×56.1×35.3
Multi tiers terminal	0.08 mm ² to 1.5 mm ² AWG28 to AWG16	2	1:1	XW5T-P1.5-1.1-2	XW5G-P1.5-1.1-2	3.5×65.7×41.1
	0.14 mm ² to 2.5 mm ² AWG26 to AWG14			XW5T-P2.5-1.1-2	XW5G-P2.5-1.1-2	5.2×78.8×45.9
	0.2 mm ² to 4.0 mm ² AWG24 to AWG12			XW5T-P4.0-1.1-2	XW5G-P4.0-1.1-2	6.2×85×45.9
Multi conductor terminals	0.08 mm ² to 1.5 mm ² AWG28 to AWG16	1	1:2	XW5T-P1.5-1.2-1	XW5G-P1.5-1.2-1	3.5×54.1×30.5
	0.14 mm ² to 2.5 mm ² AWG26 to AWG14			XW5T-P2.5-1.2-1	XW5G-P2.5-1.2-1	5.2×60.5×35.3
	0.2 mm ² to 4.0 mm ² AWG24 to AWG12			XW5T-P4.0-1.2-1	XW5G-P4.0-1.2-1	6.2×66.5×35.3
	0.08 mm ² to 1.5 mm ² AWG28 to AWG16	1	2:2	XW5T-P1.5-2.2-1	XW5G-P1.5-2.2-1	3.5×63.2×30.5
	0.14 mm ² to 2.5 mm ² AWG26 to AWG14			XW5T-P2.5-2.2-1	XW5G-P2.5-2.2-1	5.2×72.2×35.3
	0.2 mm ² to 4.0 mm ² AWG24 to AWG12			XW5T-P4.0-2.2-1	XW5G-P4.0-2.2-1	6.2×76.9×35.3

Common Terminal Blocks

XW6T

Cat. No. G139

- Downsize Control Panels and Save Work with Common Terminal Blocks with Visible Indicators
- Indicators make wiring completion simply visible. Proper wiring without skillful operators.



Common specifications		Applicable wire sizes*1	Model	Size W×H×D (mm)	Applicable wire sizes*	Model	Size W×H×D (mm)
Number of pins	Color of Short Bars						
8	Red	0.08~1.5 mm ² / AWG28~16	XW6T-COM1.5X8RD	9.2×78 ×31.3	0.14 to 2.5 mm ² / AWG26 to 14	XW6T-COM2.5X8RD	12.6×82.6 ×36.1
	Blue		XW6T-COM1.5X8BL			XW6T-COM2.5X8BL	
	Yellow		XW6T-COM1.5X8YL			XW6T-COM2.5X8YL	
12	Red		XW6T-COM1.5X12RD	12.7×78×31.3		XW6T-COM2.5X12RD	17.8×82.6 ×36.1
	Blue		XW6T-COM1.5X12BL			XW6T-COM2.5X12BL	
	Yellow		XW6T-COM1.5X12YL			XW6T-COM2.5X12YL	
16	Red		XW6T-COM1.5X16RD	16.2×78×31.3		XW6T-COM2.5X16RD	23.0×82.6 ×36.1
	Blue		XW6T-COM1.5X16BL			XW6T-COM2.5X16BL	
	Yellow		XW6T-COM1.5X16YL			XW6T-COM2.5X16YL	
20	Red		XW6T-COM1.5X20RD	19.7×78×31.3		XW6T-COM2.5X20RD	28.2×82.6 ×36.1
	Blue		XW6T-COM1.5X20BL			XW6T-COM2.5X20BL	
	Yellow		XW6T-COM1.5X20YL			XW6T-COM2.5X20YL	
40	Red	XW6T-COM1.5X40RD	37.2×78×31.3	XW6T-COM2.5X40RD	54.2×82.6 ×36.1		
	Blue	XW6T-COM1.5X40BL		XW6T-COM2.5X40BL			
	Yellow	XW6T-COM1.5X40YL		XW6T-COM2.5X40YL			

*1.For stranded lines

For detailed information such as formats and options other than those listed, please refer to the catalog data sheet of each product.

Ultra-Compact Interface Wiring System

XW2K

Cat. No.G152

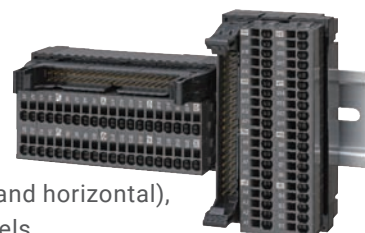

- This product is the industry's smallest*1 and is mountable in two ways (vertical and horizontal), so you can use space efficiently to downsize and save space on your control panels.
- Wiring patterns specifically designed for connections with the PLCs of each company reduce the work required for signal layout checking.

*1. According to OMRON investigation in March 2022

Ultra-Compact Connector-Terminal Blocks (For PLC Connection)

Applicable PLCs	Circuit	I/O Points	Model	Dimension W×H×D (mm)	
				Vertical mount	Horizontal mount
OMRON, Yokogawa Electric, Hitachi Industrial Equipment Systems	Circuit pattern A	32 Points	XW2K-40G-O32A	39×75×40.8	75×39×40.8
	Circuit pattern B		XW2K-40G-O32B		
	Circuit pattern A		XW2K-40G-O32C		
Mitsubishi Electric, Fuji Electric	Mixed I/O		XW2K-40G-M32		
	Mixed I/O		XW2K-40G-K32		

Ultra-Compact Connector-Terminal Blocks (For PLC Connection • Integrated Common Terminal Type)

Applicable PLCs	Circuit	I/O Points	Model	Dimension W×H×D (mm)	
				Vertical mount	Horizontal mount
OMRON	Input	16 Points	XW2K-20G-O16A-IN	52.7×75×40.8	75×52.7×40.8
	Output		XW2K-20G-O16B-OUT	39×75×40.8	75×39×40.8
OMRON, Yokogawa Electric, Hitachi Industrial Equipment Systems	Input(Circuit pattern A)	32 Points	XW2K-40G-O32A-IN	52.7×124×40.8	124×52.7×40.8
	Input(Circuit pattern C)		XW2K-40G-O32C-IN		
	Output(Circuit pattern B)		XW2K-40G-O32B-OUT	39×124×40.8	124×39×40.8
	Input(Circuit pattern C)		XW2K-40G-O32C-OUT		
Mitsubishi Electric, Fuji Electric	Input		XW2K-40G-M32-IN		
	Output	XW2K-40G-M32-OUT	39×124×40.8	124×39×40.8	
KEYENCE	Input	XW2K-34G-K32-IN	52.7×124×40.8	124×52.7×40.8	
	Output	XW2K-34G-K32-OUT	39×124×40.8	124×39×40.8	

Ultra-Compact Connector-Terminal Blocks (General-Purpose)

Circuit	Connector poles	Model	Dimension W×H×D (mm)	
			Vertical mount	Horizontal mount
Straight wiring (1:1 Circuit)	20 poles	XW2K-20G-T	39×56×40.8	56×39×40.8
	34 poles	XW2K-34G-T	39×75×40.8	75×39×40.8
	40 poles	XW2K-40G-T	39×75×40.8	75×39×40.8
	50 poles	XW2K-50G-T	39×92.5×40.8	92.5×39×40.8

■ Applicable PLCs

- OMRON : CS, CJ and NX series
- Mitsubishi Electric : MELSEC L, Q and iQ-R series
- KEYENCE : KV-1000, 3000, 5000, 5500 and Nano series
- Yokogawa Electric : FA-M3 series
- Hitachi Industrial Equipment Systems : EH-150/EHV series
- Fuji Electric : MICREX-SX series

Ultra-Compact Common Terminal Blocks

(For Sensor Power Supply)

XW2K-COM

Cat. No.G152



- Ideal for supplying power to a sensor or actuator

Number of poles	Application	Model	Dimension W×H×D (mm)
20 poles	For + common	XW2K-COM20N	14.8×75×29.4
	For - common	XW2K-COM20P	
	+/- mix	XW2K-COM20	

Note. It is a small model that is ideal for sensor power supply, but it can also be used for uses other than sensor power supply (e.g. AC circuit).

Solid State Relays for Heater G3PJ

Cat. No. J210

- Single-phase SSR for low heat generation enables carrying 25 A even for close mounting of three SSRs to contribute to downsizing of control panels.



Input terminal	Output terminal	Insulation method	Rated input voltage	Zero cross function	Rated load voltage	Rated load current (ambient temperature of 40 °C)*		Model	Size W×H×D (mm)
						Close mounting (Three SSRs)	Separate mounting		
Push-In Plus terminal blocks	Screw terminals	Phototriac coupler	12 to 24 VDC	Yes	24 to 240 VAC	15A	18A	G3PJ-215B-PU DC12-24	22.5×84×100
						25A	27A	G3PJ-225B-PU DC12-24	
					100 to 480 VAC	15A	23A	G3PJ-515B-PU DC12-24	
						25A	27A	G3PJ-525B-PU DC12-24	

Power Monitors

KM-PM/KM-N2/KM-N3

KM-PM Cat.No. SGTE-729 KM-N2/KM-N3 Cat.No. N213
--



- Solve design, installation, and operation topics with one model for each installation type
- Designed for global use, with support for three-phase 4-wire and 480V.

Installation method	Rated input voltage (Common terminals of a power supply and a measurement voltage input.)	Communications	Model	Size W×H×D (mm)
DIN Rail mounting	3-phase 4-wire: 100 to 277 VAC (L-N), 173 to 480 VAC (L-L) 1-phase 2-wire: 100 to 277 VAC 1-phase 3-wire: 100 to 240 VAC (L-N), 200 to 480 VAC (L-L) 3-phase 3-wire: 1 phase grounded: 100 to 480 VAC (L-L) 3-phase 3-wire: ungrounded: 173 to 480 VAC (L-L)	EtherNet/IP™ Modbus TCP	KM-PMBN-EIP	38×124×104
	1-phase 2-wire: 100 to 277 VAC 1-phase 3-wire: 100 to 220 VAC (L-N), 200 to 440 VAC (L-L) 3-phase 3-wire: 173 to 277 VAC (L-L) 3-phase 4-wire (earthed neutral): 100 to 254 VAC (L-N), 173 to 440 VAC (L-L) 3-phase 4-wire (unearthed neutral): 100 to 120 VAC (L-N), 173 to 208 VAC (L-L)	RS-485 communications, pulse output	KM-N2-FLK	90×90×65

Installation method	Applicable phase wiring methods	Power supply voltage	Communications	Model	Size W×H×D (mm)
On-panel installation	Single-phase, 2-wire: 100 to 277 VAC Single-phase, 3-wire: 100 to 240 VAC (L-N), 200 to 480 VAC (L-L) Three-phase, 3-wire: 173 to 277 VAC (L-L) Three-phase, 4-wire (earthed neutral): 100 to 277 VAC (L-N), 173 to 480 VAC (L-L) Three-phase, 4-wire (unearthed neutral): 100 to 120 VAC (L-N), 173 to 208 VAC (L-L)	100 to 240 VAC Separate from measurement voltage	RS-485 communications, pulse output	KM-N3-FLK	96×96×64

For detailed information such as formats and options other than those listed, please refer to the catalog data sheet of each product.

Uninterruptible Power Supply (UPS) S8BA

Cat. No. U701

- DIN rail to provide an ideal countermeasure for momentary power losses and power failures in industrial computers (IPC) and controllers.



Integrated battery type

Input voltage	Output current/ capacity	Model	Size W×H×D(mm)
24 VDC	5 A/120 W	S8BA-24D24D120LF	94×100×100
	10 A/240 W	S8BA-24D24D240LF	148×100×100
	15 A/360 W	S8BA-24D24D360LF	270×100×100
	20 A/480 W*1	S8BA-24D24D480LF	

*1.16.7 A/400 W for use as a UL compliant device.

Separated battery type: Control unit

Input voltage	Output current/ capacity	Model	Size W×H×D(mm)
24 VDC	20 A/480 W	S8BA-24D24D480SBF	44×124×120.9
	40 A/960 W	S8BA-24D24D960SBF	52×124×120.9

Separated battery type: Battery unit

Rated voltage	Rated capacity	UPS Model : Required units	Model	Size W×H×D (mm)
25.2 VDC	3900 mAh	S8BA-24D24D480SBF	S8BA-S480L	80×124×120.9
		S8BA-24D24D480SBF	S8BA-S960L	
	7800 mAh	S8BA-24D24D960SBF		150×124×120.9

Pushbutton Switches / Emergency Stop Pushbutton Switches A22N-P/A22NE-P

- Pushbutton with Push-In Plus technology for easy wiring
- Improved workability in wiring and installation
- Changes to the wiring direction and a shorter body provide freedom in the layout

- In a model equipped with Lock-lever-linked contact function, the improper installation of the Switch Unit can be detected.
- Improved Workability in Wiring and Installation
- Pushbutton with Push-In Plus technology for easy wiring

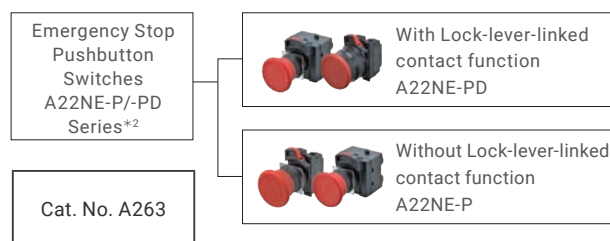
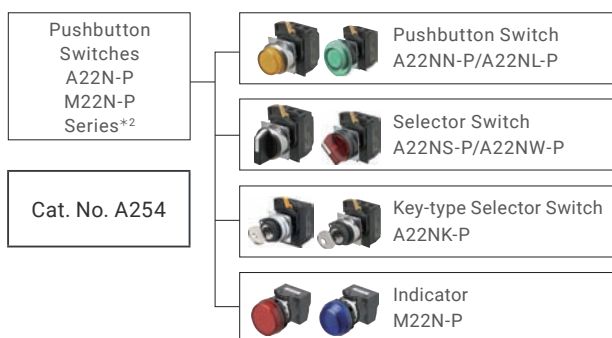

*2. For detailed format specifications and inventory information, please refer to Catalog or data sheet.

Temperature Controllers E5CC-B/E5EC-B/E5DC-B

Cat. No. H177

- Large White PV Display That's Easier to Read.
- High-speed sampling at 50 ms.
- Easy to Use, from Model Selection to Setup and Operation.
- Push-In Plus technology for easy wiring.
- Easy connections to a PLC with programless communications.
Use component communications to link Temperature Controllers to each other.



E5CC-B (48 × 48 mm)

Control outputs	Auxiliary outputs	Power supply voltage	Options					Model	Size W×H×D (mm)	
			HB alarm and HS alarm	Communications	Event inputs	Remote SP Input	Transfer output			
Control output 1 : Relay output Control output 2 : None	2	100 to 240 VAC	—	—	—	—	—	E5CC-RX2ABM-000	48×48× 67.4*1	
			1	—	2	—	—	E5CC-RX2ABM-001		
			1	RS-485	—	—	—	E5CC-RX2ABM-002		
			—	RS-485	2	—	—	E5CC-RX2ABM-004		
			—	—	2	—	Provided.	E5CC-RX2ABM-006		
			—	—	—	—	—	E5CC-RX2DBM-000		
		24 VAC/ DC	1	—	2	—	—	E5CC-RX2DBM-001		
			1	RS-485	—	—	—	E5CC-RX2DBM-002		
			—	RS-485	2	—	—	E5CC-RX2DBM-004		
			—	—	2	—	Provided.	E5CC-RX2DBM-006		
			100 to 240 VAC	—	—	—	—	—		E5CC-QX2ABM-000
				1	—	2	—	—		E5CC-QX2ABM-001
1	RS-485	—		—	—	E5CC-QX2ABM-002				
—	RS-485	2		—	—	E5CC-QX2ABM-004				
—	—	2		—	Provided.	E5CC-QX2ABM-006				
—	—	—		—	—	E5CC-QX2DBM-000				
24 VAC/ DC	1	—	2	—	—	E5CC-QX2DBM-001				
	1	RS-485	—	—	—	E5CC-QX2DBM-002				
	—	RS-485	2	—	—	E5CC-QX2DBM-004				
	—	—	2	—	Provided.	E5CC-QX2DBM-006				
Control output 1 : Linear current output Control output 2 : None	2	100 to 240 VAC	—	—	—	—	E5CC-CX2ABM-000			
			—	RS-485	2	—	E5CC-CX2ABM-004			
		24 VAC/ DC	—	—	—	—	E5CC-CX2DBM-000			

*1.The depth is the size under the neck.

For detailed information such as formats and options other than those listed, please refer to the catalog data sheet of each product.

E5EC-B (48 ×96 mm)

Control outputs	Auxiliary outputs	Power supply voltage	Options					Model	Size W×H×D (mm)
			HB alarm and HS alarm	Communications	Event inputs	Remote SP Input	Transfer output		
Control output 1 : Relay output Control output 2 : None	2	100 to 240 VAC	—	—	—	—	—	E5EC-RX2ABM-000	48×96× 67.4
			1	RS-485	2	—	—	E5EC-RX2ABM-008	
			1	—	4	—	—	E5EC-RX2ABM-010	
	4	100 to 240 VAC	1	—	6	Provided.	Provided.	E5EC-RX2ABM-011	
			—	—	—	—	—	E5EC-RX2DBM-000	
			—	—	—	—	—	E5EC-RX4ABM-000	
Control output 1 : Voltage output (for driving SSR) Control output 2 : None	2	100 to 240 VAC	—	—	—	—	—	E5EC-RX4ABM-008	
			1	RS-485	2	—	—	E5EC-RX4ABM-010	
			1	—	4	—	—	E5EC-RX4ABM-011	
	4	100 to 240 VAC	—	—	—	—	—	E5EC-QX2ABM-000	
			1	—	6	Provided.	Provided.	E5EC-QX2ABM-011	
			—	—	—	—	—	E5EC-QX2DBM-000	
Control output 1 : Linear current output Control output 2 : None	2	100 to 240 VAC	—	—	—	—	—	E5EC-QX4ABM-000	
			1	RS-485	2	—	—	E5EC-QX4ABM-008	
			1	—	4	—	—	E5EC-QX4ABM-010	
	4	100 to 240 VAC	—	—	—	—	—	E5EC-QX4ABM-011	
			—	—	—	—	—	E5EC-CX2ABM-000	
			—	—	—	—	—	E5EC-CX2ABM-004	
Control output 1 : Linear current output Control output 2 : None	2	24 VAC/ DC	—	—	—	—	—	E5EC-CX2ABM-000	
			—	—	—	—	—	E5EC-CX2ABM-004	
			—	—	—	—	—	E5EC-CX2DBM-000	
	4	100 to 240 VAC	—	—	—	—	—	E5EC-CX4ABM-000	
			—	—	—	—	—	E5EC-CX4ABM-004	
			—	—	—	—	—	E5EC-CX4ABM-004	
4	24 VAC/ DC	—	—	—	—	—	E5EC-CX4DBM-000		
		—	—	—	—	—	E5EC-CX4DBM-004		
		—	—	—	—	—	E5EC-CX4DBM-004		

E5DC-B (22.5 mm Wide, and DIN Track-mounting Type)

Control outputs	Auxiliary outputs	Power supply voltage	Options					Model	Size W×H×D (mm)
			HB alarm and HS alarm	Communications	Event inputs	Remote SP Input	Transfer output		
Control output 1 : Relay output Control output 2 : None	—	100 to 240 VAC	—	RS-485	—	—	—	E5DC-RX0ABM-015	22.5×96 ×90*1
		24 VAC/ DC	—	RS-485	—	—	—	E5DC-RX0DBM-015	
	2	100 to 240 VAC	—	—	—	—	—	E5DC-RX2ABM-000	
		24 VAC/ DC	1	RS-485	—	—	—	E5DC-RX2ABM-002	
Control output 1 : Voltage output (for driving SSR) Control output 2 : None	—	100 to 240 VAC	—	—	—	—	—	E5DC-RX2DBM-000	
		24 VAC/ DC	1	RS-485	—	—	—	E5DC-RX2DBM-002	
	2	100 to 240 VAC	—	RS-485	—	—	—	E5DC-QX0ABM-015	
		24 VAC/ DC	—	RS-485	—	—	—	E5DC-QX0DBM-015	
	2	100 to 240 VAC	—	—	—	—	—	E5DC-QX2ABM-000	
		24 VAC/ DC	1	RS-485	—	—	—	E5DC-QX2ABM-002	
		—	—	—	—	—	—	E5DC-QX2DBM-000	
		—	—	—	—	—	—	E5DC-QX2DBM-002	
Control output 1 : Linear current output Control output 2 : None	—	100 to 240 VAC	—	RS-485	—	—	—	E5DC-CX0ABM-015	
		24 VAC/ DC	—	RS-485	—	—	—	E5DC-CX0DBM-015	
	2	100 to 240 VAC	—	—	—	—	—	E5DC-CX2ABM-000	
		24 VAC/ DC	1	RS-485	—	—	—	E5DC-CX2ABM-002	
	2	100 to 240 VAC	—	—	—	—	—	E5DC-CX2DBM-000	
		24 VAC/ DC	1	RS-485	—	—	—	E5DC-CX2DBM-002	

*1.The depth is the size under the neck.

Table of applicable wires for control panel solution products and recommended products

Recommended ferrules and applicable wires^①

Wire diameter						Common to S8VK-S/S8VK-W/S8AS2												
mm ²	AWG	Stripping length (Unit:mm)	Recommended ferrules			mm ²	MIN	MAX	2	0.34	0.5	0.34	0.75	0.5	2	0.75	4	0.25
			Manufactured by Phoenix Contact	Manufactured by Weidmuller	Manufactured by Wago													
mm ²	AWG	Stripping length (Unit:mm)	Manufactured by Phoenix Contact	Manufactured by Weidmuller	Manufactured by Wago	mm ²	MIN	MAX	2	0.34	0.5	0.34	0.75	0.5	2	0.75	4	0.25
mm ²	AWG	Stripping length (Unit:mm)	Manufactured by Phoenix Contact	Manufactured by Weidmuller	Manufactured by Wago	mm ²	MIN	MAX	2	0.34	0.5	0.34	0.75	0.5	2	0.75	4	0.25
0.14	26	10	AI0,14-8	H0.14/12	-													
0.25	24	10	AI0,25-8	H0.25/12	216-301													○
		12	AI0,25-10	-	-													○
		14	AI0,25-12	-	-													
0.34	22	10	AI0,34-8	H0.34/12	216-302					○		○						○
		12	AI0,34-10	-	-					○		○						○
		14	AI0,34-12	-	-													
0.5	20	10	AI0,5-8	H0.5/14	216-201					○	○	○		○				○
		12	AI0,5-10	H0.5/16	216-241					○	○	○		○				○
		14	AI0,5-12	-	216-261													
0.75	18	10	AI0,75-8	H0.75/14	216-202					○	○	○	○	○		○		○
		12	AI0,75-10	H0.75/16	216-242					○	○	○	○	○		○		○
		14	AI0,75-12	H0.75/18	216-262													
1/1.25	18/17	10	AI1-8	H1.0/14	216-203					○	○	○	○	○		○		○
		12	AI1-10	H1.0/16	216-243					○	○	○	○	○		○		○
		14	AI1-12	H1.0/18	216-263													
1.25/1.5	17/16	10	AI1,5-8	H1.5/14	216-204					○	○	○	○	○		○		○
		12	AI1,5-10	H1.5/16	216-244					○	○	○	○	○		○		○
		14	AI1,5-12	H1.5/18D	216-264													
2/2.5	14	12	AI2,5-10	H2.5/16DS	216-246		○		○	○	○	○	○	○	○	○		○
		14	AI2,5-12	H2.5/19D	216-266													
3.5/4	12	14	AI4-12	H4.0/20D	216-267													○
6	10	16	AI6-12	H6.0/20	216-208													○
6	10	21	AI 6-18	H6.0/26DS	FE-6.0-18N-YE													
10	8	21	AI10-18	H10.0/28	216-289													

Note :Some models may use ferrules without an insulation sleeve. For details, please check the data sheet for each product.

Recommended crimp tool

Phoenix Contact		Weidmuller		Wago	
Name / Model	Applicable wire diameter	Name / Model	Applicable wire diameter	Name / Model	Applicable wire diameter
CRIMPFOX 6 CRIMPFOX 6TF CRIMPFOX 10S CRIMPFOX 25R	0.25~6 mm ² /AWG24-10 0.25~6 mm ² /AWG24-10 0.14~10 mm ² /AWG25-7 10~25 mm ² /AWG8-4	PZ 6 roto PZ 16	0.14~6 mm ² 6~16 mm ²	Variocrimp 4, 206-1204 Variocrimp 16 206-225, 206-1225	0.25~4 mm ² /AWG24-12 6-16 mm ² /AWG10-6 10,16,22,25 mm ²

Product category/Model																					
Power Supply																Noise Filter			DC Electronic Circuit Protector		
S8VK-WA24024		S8VK-WA48024		S8VK-WA96024		S8VK-WA202□□		Common to S8VK-W	S8AS2-24024			S8AS2-48024			Common to S8AS2	Common to S8V-NF	S8V-NFS203	S8V-NFS206	S8V-CP		
Input side	Output side	Input side	Output side	Input side	Output side	Input side	Output side	Signal Output / COM	Input side	Output side	COM	Input side	Output side	COM	Signal Output	PE	Input side	Output side	All terminals (Excluding Power input)	Power input	
0.34	2	0.5	4	0.75	10	2	6	0.25	0.5	0.5	2	0.75	0.5	4	0.25	2	0.5	0.75	0.25	0.25	
2.5	2.5	2.5	6	2.5		2.5	10	2.5	2.5	2.5	4	2.5	2.5		2.5	2.5	2.5	2.5	2.5	2.5	2.5
22	14	20	12	18	8	14	10	24	20	20	14	18	20	12	24	14	20	18	24	24	
14		14	10	14		14	8	14	14	14	14	14	14		14		14	14	14	14	14
								○							○				○	○	
								○							○				○	○	
○								○							○				○	○	
○								○							○				○	○	
○		○						○	○	○					○		○		○	○	
○		○		○				○	○	○					○		○	○	○	○	
○		○		○				○	○	○					○		○	○	○	○	
○		○		○				○	○	○					○		○	○	○	○	
○		○		○				○	○	○					○	○	○	○	○	○	
○	○	○		○				○	○	○	○	○	○		○	○	○	○	○	○	
						○														○	
			○																	○	
			○																	○	
							○														
					○		○														

Recommended Flat-blade screwdriver

Phoenix Contact	Weidmuller	Wago	Wera	Wiha	Facom	Vessel
SZS 0,4×2,5 SZF 0-0,4×2,5 *1	SDIS 0.4×2.5×75	210-719	ESD 0,40 x 2,5	0.4×2.5×75 302	AEF.2,5×75	9900 (-2.5×75)

*1. OMRON's exclusive purchase XW4Z-00B is available to order as SZF 0-0,4×2,5 (manufactured by Phoenix Contact).

For the DC output terminal of S8VK-WA96024, use the following flat-blade screwdriver.

Phoenix Contact	Weidmuller	STANLEY	Wera	Wiha	Facom	Vessel
SZF 2-0,8×4,0	SDS 0.8×4.0×100	1-65-017	ESD 0,80×4,0	302S4010	AEF.4×75	990 (-4×100)

Recommended ferrules and applicable wires②

						Low Voltage Switching Gears				
						J7KC、J7TC、J7KCA		J7MC		
						Applicable terminals Wire diameter	All terminals		All terminals	
							mm ²	MIN	0.5	0.5
						AWG	MAX	2	4	
						mm ²	MIN	20	20	
						AWG	MAX	14	12	
Wire diameter	Stripping length (Unit:mm)		Recommended ferrules							
mm ²	AWG		Manufactured by Phoenix Contact	Manufactured by Weidmuller	Manufactured by Wago					
0.14	26	10	AI0,14-8	H0.14/12	-					
0.25	24	10	AI0,25-8	H0.25/12	216-301					
		12	AI0,25-10	-	-					
		14	AI0,25-12	-	-					
0.34	22	10	AI0,34-8	H0.34/12	216-302					
		12	AI0,34-10	-	-					
		14	AI0,34-12	-	-					
0.5	20	10	AI0,5-8	H0.5/14	216-201	○	○			
		12	AI0,5-10	H0.5/16	216-241	○				
		14	AI0,5-12	-	216-261					
0.75	18	10	AI0,75-8	H0.75/14	216-202	○	○			
		12	AI0,75-10	H0.75/16	216-242	○				
		14	AI0,75-12	H0.75/18	216-262					
1/1.25	18/17	10	AI1-8	H1.0/14	216-203	○	○			
		12	AI1-10	H1.0/16	216-243	○				
		14	AI1-12	H1.0/18	216-263					
1.25/1.5	17/16	10	AI1,5-8	H1.5/14	216-204	○	○			
		12	AI1,5-10	H1.5/16	216-244	○				
		14	AI1,5-12	H1.5/18D	216-264					
2/2.5	14	12	AI2,5-10	H2.5/16DS	216-246	△ *1	○			
		14	AI2,5-12	H2.5/19D	216-266					
3.5/4	12	14	AI4-12	H4.0/20D	216-267					
6	10	16	AI6-12	H6.0/20	216-208					
10	8	21	AI10-18	H10.0/28	216-289					

Note :Some models may use ferrules without an insulation sleeve. For details, please check the data sheet for each product.

*1. Wide Muller-made ferrules cannot be used.

Recommended crimp tool

Phoenix Contact		Weidmuller		Wago	
Name / Model	Applicable wire diameter	Name / Model	Applicable wire diameter	Name / Model	Applicable wire diameter
CRIMPFOX 6 CRIMPFOX 6T-F CRIMPFOX 10S CRIMPFOX 25R	0.25~6 mm ² /AWG24-10 0.25~6 mm ² /AWG24-10 0.14~10 mm ² /AWG25-7 10~25 mm ² /AWG8-4	PZ 6 roto PZ 16	0.14~6 mm ² 6~16 mm ²	Variocrimp 4, 206-1204 Variocrimp 16 206-225, 206-1225	0.25~4 mm ² /AWG24-12 6-16 mm ² /AWG10-6 10,16,22,25 mm ²

Product category/Model					
Sockets for Relays		Sockets for Relays with Forcibly Guided Contacts	Slim I/O Relays	Terminal Relays	I/O Relay Terminals
PYF-□-PU P2RF-□-PU	PTF-□-PU	P7SA	G2RV-ST500 G3RV-ST500□	G6D-F4PU, G3DZ-F4PU	G70V
All terminals	All terminals	All terminals	All terminals	All terminals	All terminals (Excluding communication connector)
0.25	0.25	0.5	0.25	0.25	0.25
1.5	2.5	1.5	2.5	2.5	2.5
24	24	20	24	24	24
16	14	16	14	14	14
○	○		○	○	○
○	○		○	○	○
○	○		○	○	○
○	○		○	○	○
○	○	○	○	○	○
○	○	○	○	○	○
○	○	○	○	○	○
○	○	○	○	○	○
○	○	○	○	○	○
○	○	○	○	○	○
○	○	○	○	○	○
	○		○	○	○
	○			○	○

Recommended Flat-blade screwdriver

Phoenix Contact	Weidmuller	Wago	Wera	Wiha	Facom	Vessel
SZS 0,4×2,5 SZF 0-0,4×2,5 *2	SDIS 0.4×2.5×75	210-719	ESD 0,40 x 2,5	0.4×2.5×75 302	AEF.2,5×75	9900 (-2.5×75)

*2. OMRON's exclusive purchase XW4Z-00B is available to order as SZF 0-0,4×2,5 (manufactured by Phoenix Contact).

Recommended ferrules and applicable wires③

Recommended ferrules						DIN Track Terminal Blocks				
Wire diameter		Stripping length (Unit:mm)	Manufactured by Phoenix Contact	Manufactured by Weidmuller	Manufactured by Wago	Applicable terminals		All terminals	All terminals	All terminals
mm ²	AWG					mm ²	AWG			
0.14	26	10	A10,14-8	H0.14/12	-	○	○	○	○	○
0.25	24	10	A10,25-8	H0.25/12	216-301	○	○	○	○	○
		12	A10,25-10	-	-	○	○	○	○	○
		14	A10,25-12	-	-	○	○	○	○	○
0.34	22	10	A10,34-8	H0.34/12	216-302	○	○	○	○	○
		12	A10,34-10	-	-	○	○	○	○	○
		14	A10,34-12	-	-	○	○	○	○	○
0.5	20	10	A10,5-8	H0.5/14	216-201	○	○	○	○	○
		12	A10,5-10	H0.5/16	216-241	○	○	○	○	○
		14	A10,5-12	-	216-261	○	○	○	○	○
0.75	18	10	A10,75-8	H0.75/14	216-202	○	○	○	○	○
		12	A10,75-10	H0.75/16	216-242	○	○	○	○	○
		14	A10,75-12	H0.75/18	216-262	○	○	○	○	○
1/1.25	18/17	10	A11-8	H1.0/14	216-203	○	○	○	○	○
		12	A11-10	H1.0/16	216-243	○	○	○	○	○
		14	A11-12	H1.0/18	216-263	○	○	○	○	○
1.25/1.5	17/16	10	A11,5-8	H1.5/14	216-204	○	○	○	○	○
		12	A11,5-10	H1.5/16	216-244	○	○	○	○	○
		14	A11,5-12	H1.5/18D	216-264	○	○	○	○	○
2/2.5	14	12	A12,5-10	H2.5/16DS	216-246	○	○	○	○	○
		14	A12,5-12	H2.5/19D	216-266	○	○	○	○	○
3.5/4	12	14	A14-12	H4.0/20D	216-267	○	○	○	○	○
6	10	16	A16-12	H6.0/20	216-208	○	○	○	○	○
10	8	21	A110-18	H10.0/28	216-289	○	○	○	○	○

Note :Some models may use ferrules without an insulation sleeve. For details, please check the data sheet for each product.

Recommended crimp tool

Phoenix Contact		Weidmuller		Wago	
Name / Model	Applicable wire diameter	Name / Model	Applicable wire diameter	Name / Model	Applicable wire diameter
CRIMPFOX 6 CRIMPFOX 6T-F CRIMPFOX 10S CRIMPFOX 25R	0.25~6 mm ² /AWG24-10 0.25~6 mm ² /AWG24-10 0.14~10 mm ² /AWG25-7 10~25 mm ² /AWG8-4	PZ 6 roto PZ 16	0.14~6 mm ² 6~16 mm ²	Variocrimp 4, 206-1204 Variocrimp 16 206-225, 206-1225	0.25~4 mm ² /AWG24-12 6-16 mm ² /AWG10-6 10,16,22,25 mm ²

Product category/Model							
Common Terminal Blocks		Ultra-Compact Interface Wiring System	Timers, Digital Temperature Controllers, Pushbutton Switches, Solid State Relays for Heater, Component Protective Components	Power Monitors			
XW6T-COM1.5	XW6T-COM2.5	XW2K	H3DT、E5□C-B、E5□D-B、A22N-P□、M22N-P□、A22NE-P、A22NE-PD、G3PJ、K8DT	KM-N2、KM-N3		KM-PM	
All terminals	All terminals	All terminals	All terminals (input terminals for G3PJ)	Power supply	Pulse output / RS-485	Voltage input terminals	Current input terminals
0.14	0.14	0.14	0.25	0.5	0.25	0.2	0.2
0.75	2.5	0.5	1.5	1.5	1.5	4	1.5
26	26	26	24	20	24	24	24
18	14	20	16	16	16	12	16
○	○	○					
○	○	○	○		○		
○	○	○	○		○		○
						○	
○	○	○	○		○		
○	○	○	○		○		○
						○	
○	○	○	○	○	○		
○	○	○	○	○	○		○
						○	
○	○		○	○	○		
○	○		○	○	○		○
						○	
	○		○	○	○		
	○		○	○	○		○
						○	
	○					○	
						○	
						○	
						○	
						○	

Recommended Flat-blade screwdriver

Phoenix Contact	Weidmuller	Wago	Wera	Wiha	Facom	Vessel
SZS 0,4×2,5 SZF 0-0,4×2,5 *1	SDIS 0.4×2.5×75	210-719	ESD 0,40 x 2,5	0.4×2.5×75 302	AEF.2,5×75	9900 (-2.5×75)

*1. OMRON's exclusive purchase XW4Z-00B is available to order as SZF 0-0,4×2,5 (manufactured by Phoenix Contact).

OMRON's Products Support IoT for Control Panels and Production Lines



Advanced Motor Condition Monitoring Device
K7DD

Cat. No. N235-E1



Heater Condition Monitoring Device
K7TM

Cat. No. N229-E1



Insulation Resistance Monitoring Device
K7GE

Cat. No. N226-E1



Panel condition monitoring device
K6PM

Cat. No. H232-E1



Motor Condition Monitoring Devices
K6CM

Cat. No. N220-E1

2019 Released in October



Switch Mode Power Supplies
S8VK-X

Cat. No. T211-E1

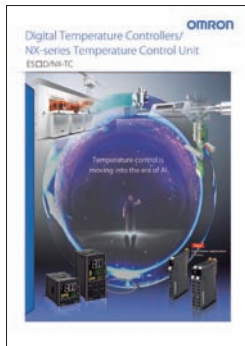

Digital Temperature Controllers
E5□D/NX-TC

Cat. No. H222-E1

Other company names and product names in this document are the trademarks or registered trademarks of their respective companies
Microsoft product screen shot(s) reprinted with permission from Microsoft Corporation.
The permission of Shutterstock.com was received for images that were used.

OMRON Corporation Industrial Automation Company

Kyoto, JAPAN

Contact : www.ia.omron.com

Regional Headquarters

OMRON EUROPE B.V.

Wegalaan 67-69, 2132 JD Hoofddorp
The Netherlands
Tel: (31) 2356-81-300 Fax: (31) 2356-81-388

OMRON ELECTRONICS LLC

2895 Greenspoint Parkway, Suite 200
Hoffman Estates, IL 60169 U.S.A.
Tel: (1) 847-843-7900 Fax: (1) 847-843-7787

OMRON ASIA PACIFIC PTE. LTD.

438B Alexandra Road, #08-01/02 Alexandra
Technopark, Singapore 119968
Tel: (65) 6835-3011 Fax: (65) 6835-3011

OMRON (CHINA) CO., LTD.

Room 2211, Bank of China Tower,
200 Yin Cheng Zhong Road,
PuDong New Area, Shanghai, 200120, China
Tel: (86) 21-6023-0333 Fax: (86) 21-5037-2388

Authorized Distributor:

©OMRON Corporation 2022-2025 All Rights Reserved.
In the interest of product improvement,
specifications are subject to change without notice.

CSM_6_4

Cat. No. Y235-E1-09 1025 (0622)