

**EQUO** Series

**OMRON**

**Air Flow Sensor**

D6FZ-FGT200  
D6FZ-FGT500  
D6FZ-FGS1000

**Air Flow Station**

D6FZ-FGX21

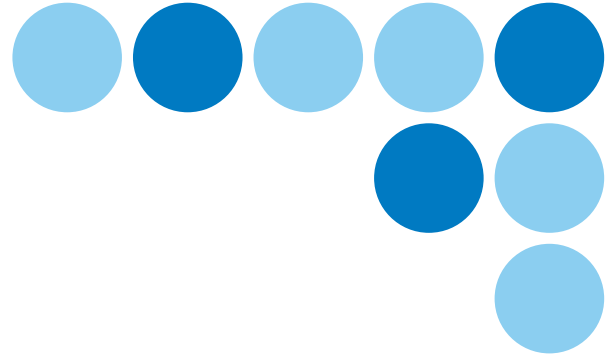

**AIR FLOW SENSOR**

**It's time to visualize  
compressed air!**



Air Flow Sensor  
D6FZ-FGS1000



Air Flow Sensor  
D6FZ-FGT200  
D6FZ-FGT500



Air Flow Station  
D6FZ-FGX21

**realizing**

# Visualization of Air Flow, Pressure, Leakage quantity enable more Energy Savings in production site.

Air compressors consume a much electrical energy in production sites. Production sites, however, prioritize improving productivity, and so energy conservation for compressed air have not much progressed. To advance further energy saving at production site, "visualizing compressed air" is a major step in on-site improvements.

**Air compressors shares 27% of total electrical energy.**

Despite energy saving activity of air compressors...

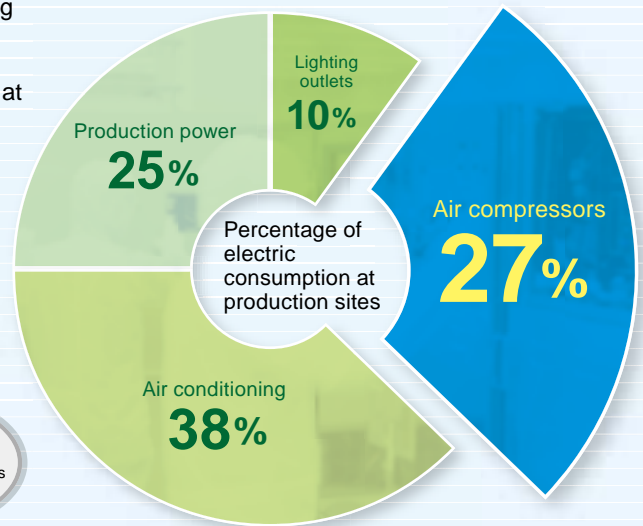
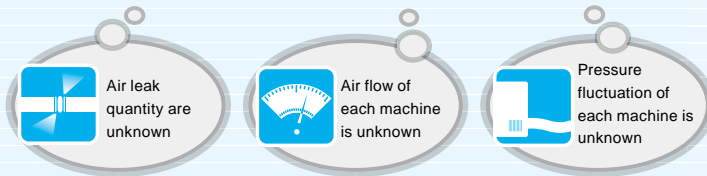

Note: Shows the status of use at Omron production sites

## As air is invisible, so there is much waste.



## Increased energy conservation is possible in a variety of applications

### Idling stop for ionizer

D6FZ-FGT

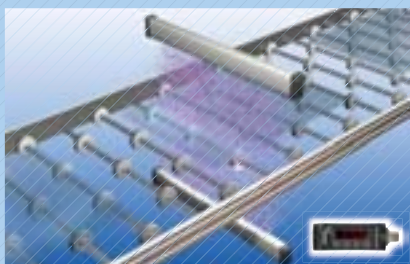

By stopping the supply of compressed air with a magnetic valve when there is no work, the quantity of compressed air usage is reduced. At the same, the flow sensor monitors the quantity of compressed air supplied to ensure that it is within a specified range. Therefore, the sensor can help maintain and improve quality.

### Flow management for molding machines

D6FZ-FGT

D6FZ-FGS



By prioritizing the monitoring of molding machines and other machines that use large quantity of compressed air, energy conservation can be advanced effectively.

**Consequently**

Require cooperation both supply side and usage side for visualization. Lead to **reduction of electric energy** or **maintenance of quality**.

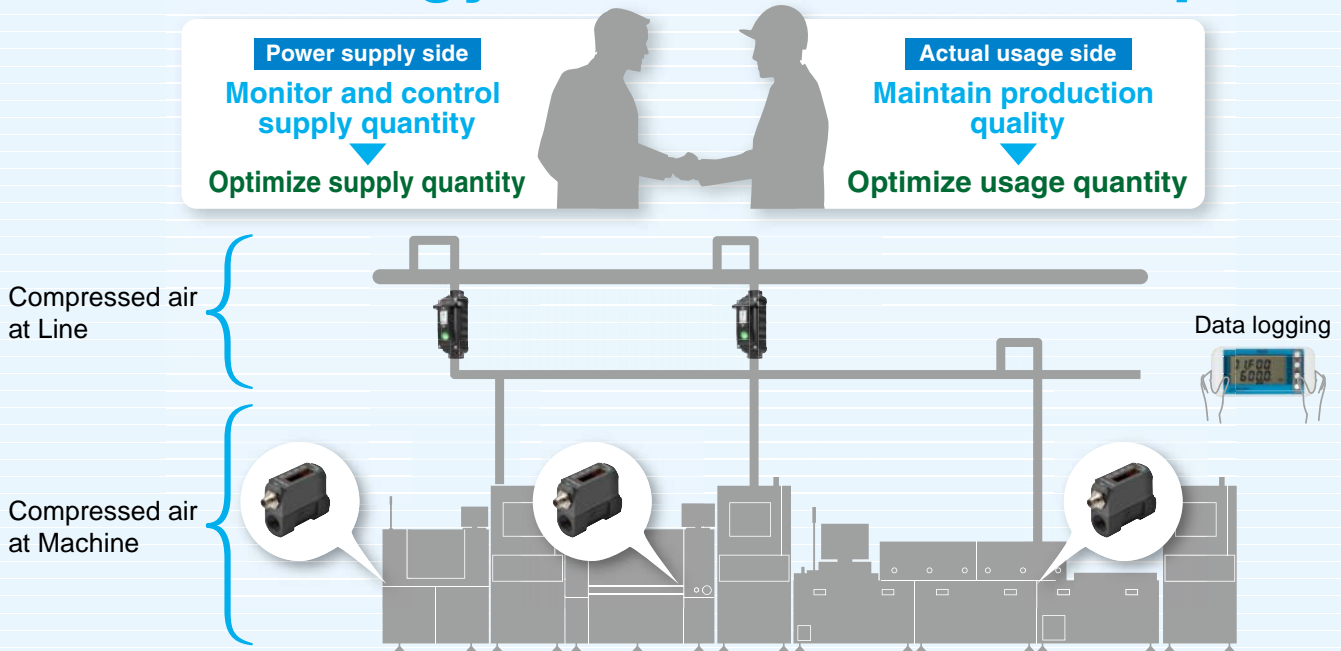

Identify the waste that had previously been invisible, and further advance the energy saving of compressed air.

**Approach 1**  
**Identifying the leakage quantity**  
 Visualizing air leakage in non-operational time

**Approach 2**  
**Identifying the usage quantity**  
 Visualizing air quantity in operational time

**Approach 3**  
**Identifying the excessive supply pressure**  
 Visualizing the pressure fluctuation in operational time

**Leakage management for machines**

D6FZ-FGT D6FZ-FGS

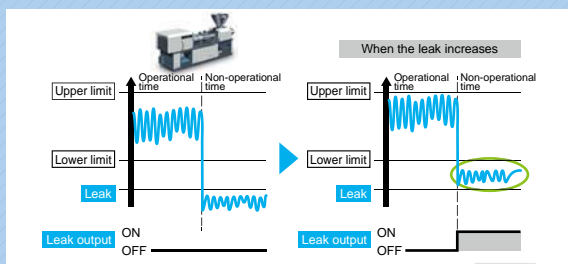

By setting the leak threshold value, the proper timing for leak repairs can be identified.



**Flow and pressure management for production line**

D6FZ-FGS

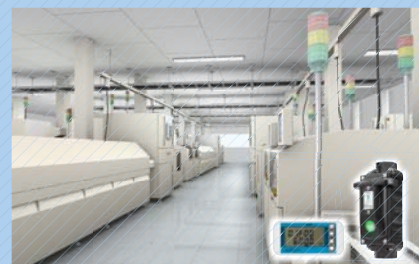

By monitoring the usage quantity and pressure fluctuations for each production line, bottleneck line or machine can be identified in order to advance on-site improvements and energy conservation.

# The best product to measure compressed air at **Line**

## D6FZ-FGS1000

1 Leakage

2 Usage

3 Pressure

Pipe size: Rc1/2 (25A)  
(Bushing can be used to convert down to 15A)

### Multiple sensing

#### Simultaneous measurement of Leakage, usage and pressure

Equipped with multiple sensing functions  
With 1 sensor, the compressed air conditions can be identified.

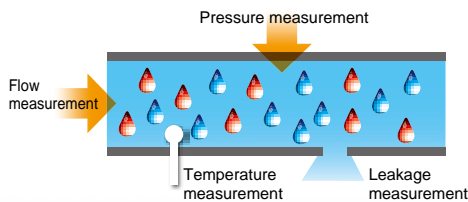

### High accuracy

#### High accuracy flow measurement

High measuring accuracy of  $\pm 2\%$  R.S. (50L/min $\leq$ ) is achieved.

#### High accuracy

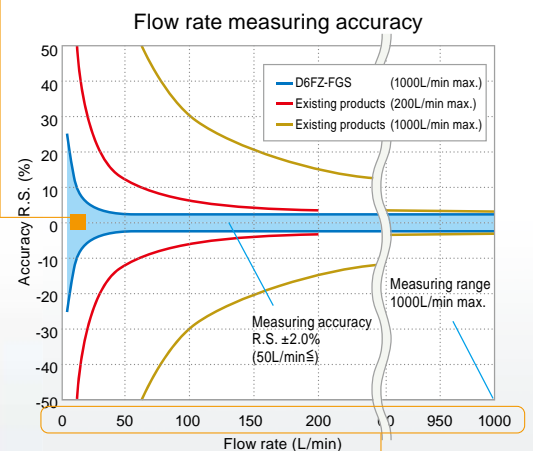

\* Data is a comparison with Omron conditions (as of November 2012)  
Check the actual use environment before use.

#### Wide range flow measurement

#### Wide range

Wide measuring range of 1~1000L/min is achieved.

### Simple setting

#### Mountable to curved pipe or coupler

#### Silencer

The built-in silencer eliminates ultrasonic noise and turbulence flow. It makes installation work easy because straight pipes not required.

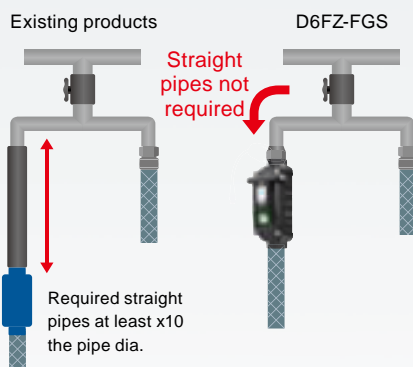

#### Tolerant of oil and mist

#### Ultrasonic sensor

Featuring ultrasonic sensor  
It can be installed to rusty pipe, and measured gas discharged from oil flooded compressor.

#### Main functions

- Analog output (2 outputs)
- Pulse output (2 outputs)
- RS-485 communications
- IP64
- Operation indicator
- Threshold value (peak/bottom/leak)
- Alarm hold

#### Functional comparison

Flow measurement	Leakage measurement	Pressure measurement	Temperature measurement
Curved pipe mounting	Tolerant of oil and mist	Station connection	Multi-sensor connection

# The best product to measure compressed air at **Machine**

1 Leakage

2 Usage

3 Pressure

## D6FZ-FGT200/500



200L type Pipe size: 8A(Rc1/4) 500L type Pipe size: 15A(Rc1/2)

### Easy to see

#### 11 segment 8 digit LCD display

The characters are easy to recognize, and integrated flow rate can be checked with one glance.



Clear integrated flow rate Averaging count setting

#### Reversing the display

You can reverse the display direction to match the installation direction. Always use one of the specified installation directions.

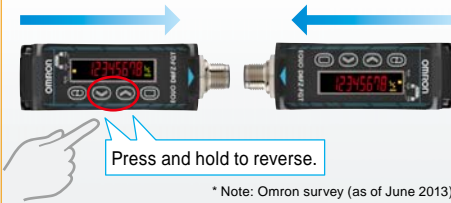

\* Note: Omron survey (as of June 2013)

### Other Features

#### Flow straightener Honeycomb structure

Honeycomb structure with a high performance of flow straightening keep pressure loss low.

#### Honeycomb structure

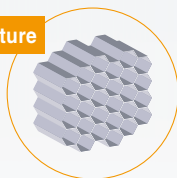

### High accuracy

#### High accuracy flow measurement

Using Omron's MEMS chip, the highest accuracy in the industry\* of  $\pm 2\%$  F.S. (50L/min $\leq$ ) is achieved.

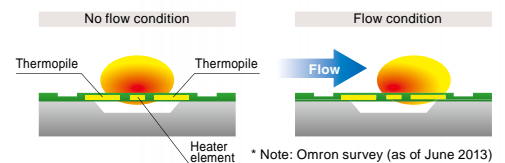

#### Leakage measurement

At a low flow rate (<50L/min),  $\pm 0.5\%$  F.S. high accuracy measurement is achieved. Air flow (money amount) that is discarded as leakage when machines are in non-operational time can be identified.



#### Zero reset

Using the zero reset, seasonal or day/night variation in the flow rate can be identified.



#### Main functions

- Analog output (1 output)
- Pulse output (2 outputs)
- RS-485 communications
- IP65
- Display
- Threshold value (peak/bottom/leak)
- Peak//Bottom hold
- Auto-tuning
- Key lock

#### Functional comparison

Flow measurement	Leakage measurement	Pressure measurement	Temperature measurement
Curved pipe mounting	Tolerant of oil and mist	Station connection	Multi-sensor connection

# Energy-Saving activity examples

## Protecting the leakage

### Repair tubing and fitting against air leaks

Identifying the flow rate and repairing pipes reduces the air lost to waste.

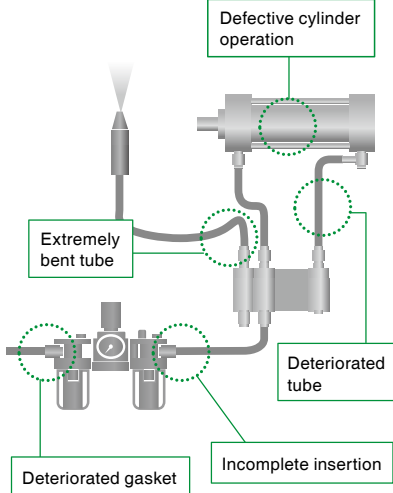

## Reducing the air quantity used

### Charging based on air usage

Management of consumption rate and charging based on usage helps to continuous activities for energy saving.

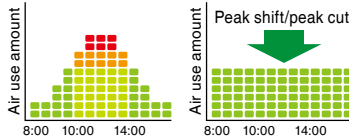

Seeing the air flow during operational time identifies the use amount

Example: Charging based on usage

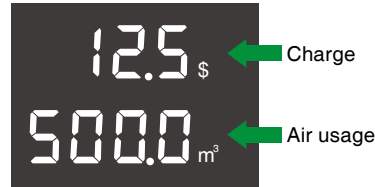

## Reducing the supply pressure

### Rearranging the pipe distribution

The machine its supply pressure fluctuate widely should be changed piping as below, and then stabilize and turn down supply pressure.

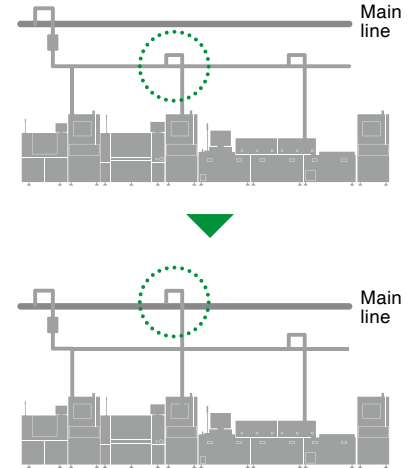

# The PC Software can easily analyze Logged Data

Enables further activity for energy saving to monitor the data of Air Flow Station and analyze the data of Multi Data Viewer Light Software.

At Production Line:

Data monitoring and storing by Air Flow Station

The Air Flow Station enables easy data logging



Save the data to SD card

Start data logging with a single press of a button

Free The PC software

## Multi Data Viewer Light

This software is suits for the display of time period, such as by minute, hour, day, etc. The integrated flow rate is displayed as a bar graph, and the momentary flow rate/pressure using a dotted line graph, so a summary can be identified at a glance.

In the office:

Data storing and analyzing by PC

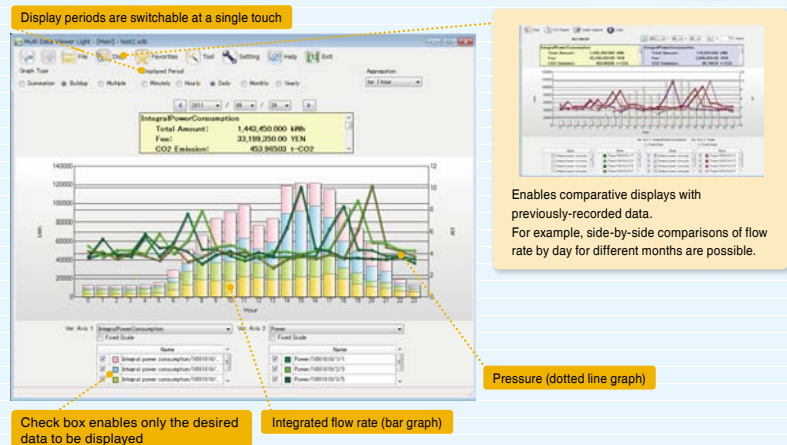

Download the PC Software Multi Data Viewer Light from the following OMRON website (<http://www.fa.omron.co.jp/multi-d-v-e>).



# Find the Energy Efficiency by logging the data simultaneously both electric consumption and production volume.

The results of simultaneous measurement, show the following

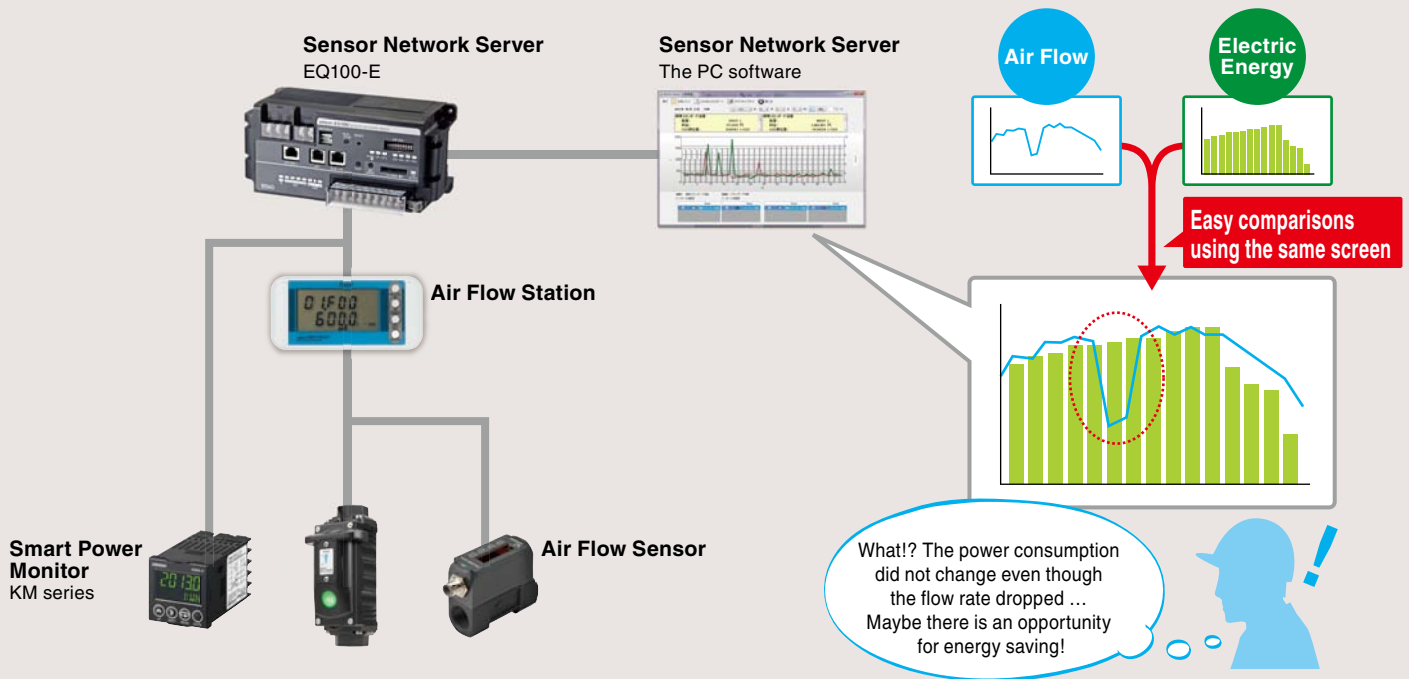



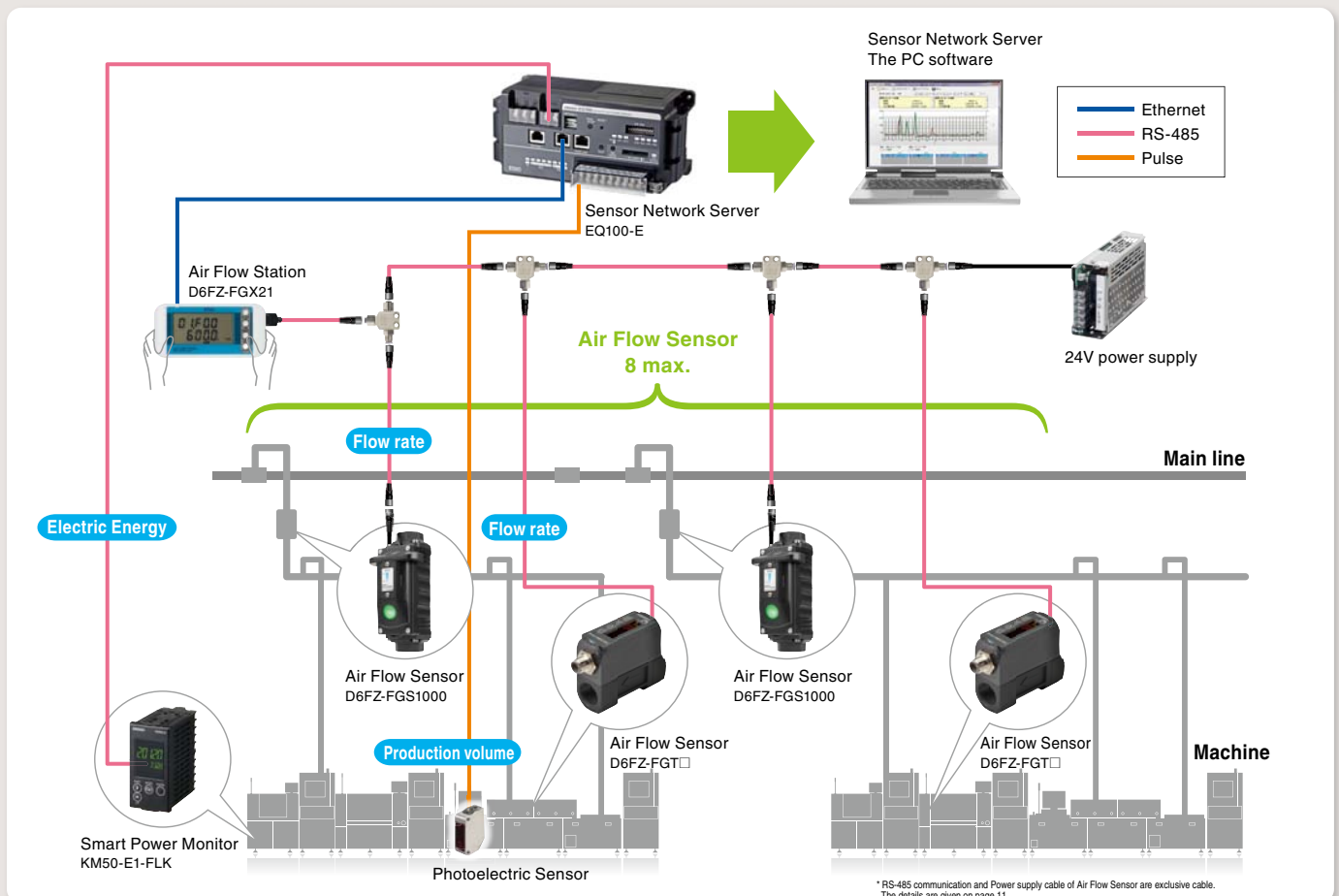

## System layout example







## List of specifications

### Units

Appearance	Product name	Model
	Air Flow Sensor (200L type)	D6FZ-FGT200
	Air Flow Sensor (500L type)	D6FZ-FGT500
	Air Flow Sensor (1000L type, cable length: 0.2m)	D6FZ-FGS1000
	Air Flow Station (Cable length 1.5m, including T-branch connector cable)	D6FZ-FGX21
	Air Flow Sensor Set (1000L type) <ul style="list-style-type: none"> <li>• Air Flow Sensor (1000L type)</li> <li>• Air Flow Station</li> <li>• T-branch connector</li> <li>• Single-end wire cable (3m)</li> </ul>	D6FZ-FGS1000-S

### Option (sold separately)

Appearance	Product name	Model		
	T-branch connector	D6FZ-FC02		
	(Air Flow Sensor D6FZ-FGT only) Mounting bracket <ul style="list-style-type: none"> <li>• Mounting bracket: 1</li> <li>• Plus screw (M3): 4</li> </ul>	D6FZ-FC03		
	(Air Flow Station D6FZ-FGX21 only) Mounting magnet* <ul style="list-style-type: none"> <li>• Mounting magnet: 2</li> <li>• Plus screw (M3): 2</li> </ul>	ZN9-EM01-S		
	Single-end wire cable	Cable length 3m	M12 connector (8 pin)	D6FZ-JD3A
		Cable length 10m		D6FZ-JD10A
		Cable length 20m		D6FZ-JD20A
	Double-end connector cable	Cable length 3m	M12 connector (8 pin)	D6FZ-JD3B
		Cable length 5m		D6FZ-JD5B
		Cable length 10m		D6FZ-JD10B
		Cable length 20m		D6FZ-JD20B

\* When magnets are used, the maximum vibration resistance is 55Hz.



## Ratings

### Air Flow Sensor

Item	Model	D6FZ-FGT200	D6FZ-FGT500
Applicable fluid		Air, nitrogen (N <sub>2</sub> )* <sup>1</sup>	
Working pressure		0.75MPa (withstand pressure 1.5MPa)	
Measurement range* <sup>2</sup>		0 to 200L/min	0 to 500L/min
Measurement accuracy range* <sup>2</sup>		2 to 200L/min	5 to 500L/min
Display Resolution* <sup>2</sup>		1L/min	
Accuracy* <sup>2</sup>		±2.0%F.S. at 50L/min or more	
		±0.5%F.S. at less than 50L/min	
Temperature characteristic		±3%F.S.	
Repeat accuracy		±1%F.S.	
Operating temperature		Operation: -10 to 60°C / Storage: -20 to 70°C (no condensation or icing)	
Operating humidity		Operation: 25 to 90%RH / Storage: 0 to 90%RH (no condensation or icing)	
Shock resistance		150 m/s <sup>2</sup> in 6 directions (+/-X, +/-Y, and +/-Z directions), 3 times each	
Pressure loss		2kPa max.	4kPa max.
Power supply voltage		12 to 24 VDC ±10% ripple (p-p) 10% max.	
Current consumption		120mA max.	
Functions		Momentary flow / Integrated flow / Reversing display / Zero point Adjustment / Peak and Bottom Hold / Key Lock / Eco Mode / Scaling (Analog Output) / Judgement Hysteresis / Teaching	
Display		11-segment digital display (Red), RUN / FUN / THR (Yellow), Out1 / Out2 (Yellow), Key Lock (Yellow), Flow unit (Green), Flow unit in reversed display (Yellow)	
Output	Output interface	Analog	Current output 4 to 20mA (1 contact), maximum load resistance 300Ω max.
		ON/OFF	Open collector output (2 outputs) 26.4 VDC 50mA max. ON residual voltage 2V max. (Outputs can be selected from judgement output, pulse output and unit error output)
		RS-485	2-wire half duplex communication, start-stop synch method Baud rate: 9.6k/19.2k/38.4k/115.2kbps, data bit length: 7/8bit, stop bit length: 1/2bit, parity: none/even/odd, termination resistor (120Ω): ON/OFF, communications protocol: compatible with CompoWay/F
	Output values		Momentary flow, Integrated flow, Judgement output *3, Unit error output
Degree of protection		IP65	
Installation Direction and Straight Pipe Section		A straight pipe section must be provided during installation and piping if the Sensor is installed horizontally and the display is on the top. *4	
Connection bore diameter		Rc1/4 (8A)	Rc1/2 (15A)
Material		Main unit: PBT / Flow channel: Zinc	
Dimensions		30(W) × 77(D) × 63.7(H) mm	
Weight (in package)		Approx. 400 g (500 g)	
Accessories		Instruction Sheet	

\*1. Clean Dry Gas (must not contain large particle e.g. dust, oil and mist)

\*2. Converted value assuming the accumulated flow quantity following conditions

std (factory default) : 20°C at 1 atmospheric pressure 101.3kPa, nor : 0°C at 1 atmospheric pressure 101.3kPa

\*3. To prevent chattering, a judgement output is made when the judgement continues for one minute or longer.

\*4. The accuracy will depend on the length of the straight pipe section. Refer to *Flow rate accuracy characteristics* for a length of straight pipe on page 12 for details.

Item	Model	D6FZ-FGS1000	
Applicable fluid	Air, nitrogen (N <sub>2</sub> )		
Working pressure	0.99MPa max.		
Measurement	Flow* <sup>1</sup>	Detection range	1 to 1,000L/min (std)
		Resolution	0.1L/min
		Accuracy	±2.0% of reading at 50 L/min (std) or more* <sup>2</sup> ±0.1%F.S. at less than 50L/min
	Pressure	Detection range	0 to 0.99MPa
		Accuracy	±2%F.S.
	Temperature	Detection range	-10 to 60°C
Accuracy		±1.5% (absolute temperature)	
Resistance to environment	Operating temperature		-10 to 60°C (no condensation or icing)
	Operating humidity		35 to 85%RH (no condensation or icing)
	Vibration resistance		10 to 55Hz double amplitude: 0.7mm, Acceleration: 50m/s <sup>2</sup> in X, Y and Z directions (80min)
	Shock resistance		150 m/s <sup>2</sup> in 6 directions (+/-X, +/-Y, and +/-Z directions), 3 times each
Pressure loss	Direct piping:10kPa max. (0.5MPa, at maximum flow) Using coupler (TL type by NAGAHORI INDUSTRY CO., LTD.): 10kPa max. (0.5MPa, at maximum flow)		
Power supply voltage	16 to 24 VDC ±10% ripple (p-p) 10% max. (Using single unit), 24 VDC ±10% ripple (p-p) 10% max. (Using multiple units) * <sup>3</sup>		
Power consumption	2W max.		
Measurement cycle	Approx. 62.5ms		
Display	Display method		Status display by 2-color LED (illumination/blinking)
	Display value		Presence or absence of current-carrying, flow and error alarm
Output	Output interface	Analog	Current output 4 to 20mA (2 contact)* <sup>4</sup> Max. load resistance 270Ω max.
		ON/OFF	Open drain output (2 outputs)* <sup>5</sup> 24 VDC 50mA max. ON residual voltage 1.5V max., OFF leakage current 50μA max.
		RS-485	2-wire half duplex communication, start-stop synch method Baud rate: 115.2kbps (fixed), Data bit length: 8 bits (fixed), stop bit length: 1 bit (fixed), parity: even (fixed), communications protocol: compatible with CompoWay/F
	Output values		Momentary standard flow, Integrated standard flow, pressure, temperature, unit error output
Degree of protection	IP64 (except the case with the switch cover removed)		
Wiring connection	M12 connector (8-pin)		
Connection bore diameter	Rc1 (25A) bushing enables conversion to 15A and 20A		
Material	Cable: PVC (Polyvinyl Chloride); Main unit: Aluminum die-cast; Display: Acrylic		
Dimensions	64(W) × 93(D) × 195(H) mm (excluding flange)		
Weight (in package)	Approx. 1.2 Kg (Approx. 1.7 Kg)		
Accessories	Instruction Sheet		

\*1. Converted value assuming the accumulated flow quantity under the conditions of 20°C at 1 atmospheric pressure 101.3kPa.

\*2. Does not include pressure and temperature accuracy. Conversion accuracy to the standard flow is ±2.5% of reading (at 20°C, 0.5 MPa).

\*3. Make sure to ground the 0V terminal, and do not ground the 24V(+) terminal. There is a risk of malfunction.

\*4. Analog output comprise the momentary standard flow rate and pressure.

\*5. The integrated standard flow of the pulse output can be selected from 1, 10 (factory default), 100, or 1000 L(std)/P.

## Air Flow Station

Item	Model	D6FZ-FGX21
Connectable sensor		D6FZ-FGT200 / D6FZ-FGT500 / D6FZ-FGS1000
Maximum number of mounted Sensors		8 units* <sup>1</sup>
Display		7-seg. 5-digit 2-step LCD display, auxiliary information indicator displays
Recording interval		1 s, 2 s, 5 s, 10 s, 20 s, 30 s, 1 min.
Displayed data		Momentary flow rate, integrated flow rate, pressure, temperature, charge/CO <sub>2</sub> conversion value
Recorded data		Momentary flow rate, integrated flow rate, volume flow rate, pressure, temperature
Operation function		Conversion of integrated flow rate to charge/CO <sub>2</sub>
Recording mode		Continue mode* <sup>2</sup> , Ring mode* <sup>3</sup>
External output		Alarm output (Photocoupler output) * <sup>4</sup>
Communication interface		Ethernet (10BASE-T, 100BASE-TX)
Internal storage device		Internal memory: Approx. 4200 data items when 1 unit is connected, approx. 650 data items when 8 units are connected
External storage device		SD card (measured value saving/set value saving and reading), Recommended SD card: HMC-SD291 (2 GB) * <sup>9</sup> and HMC-SD491 (4 GB) (manufactured by OMRON) * <sup>5</sup>
Power supply voltage		DC input: 24 VDC±10% ripple (p-p) 10% max.
Current consumption		80 mA max.
Operating temperature		Without Ethernet: -10°C to 40°C (no condensation or icing), with Ethernet: 0°C to 40°C (no condensation or icing)
Operating humidity		35 to 85%RH (no condensation or icing)
Storage humidity/temperature		-15°C to 60°C, 20% to 85%RH (no condensation or icing)
Insulation resistance		20 MΩ (500 VDC)
Withstand voltage		1000 VAC, 50/60 Hz, 1 min.
Vibration resistance		10 to 150 Hz, 0.7 mm double amplitude, acceleration: 50 m/s <sup>2</sup> for each in X, Y and Z directions for 80 min
Shock resistance		150 m/s <sup>2</sup> in 6 directions (+/-X, +/-Y, and +/-Z directions), 3 times each* <sup>6</sup>
Material		ABS
Degree of protection		IP30
Mounting		Magnet mounting, screw mounting, hook
Dimensions		117.2(W) × 24.6(D) × 56.8(H) mm (Except protruding part)
Weight (in package)		Approx. 150 g (Approx. 500 g)
Accessories		Instruction Sheet, Startup Guide, T-branch connection cable* <sup>7</sup> , Alarm Output Connector* <sup>8</sup>

\*1. Up to 8 units can be connected when the recording cycle is 2 seconds or longer; up to 4 units when the recording cycle is 1 second.

\*2. Automatically writes the data to the SD memory card when the internal memory reaches its capacity and continues recording until the SD card memory capacity reaches its limit.

The unit stops operation if there is no SD memory card inserted when the internal memory reaches its capacity, or when it is write protected. (Recording can be resumed after inserting an SD memory card and outputting the data to it at a press of button.)

The factory default is continue mode. Use the PC software to change the recording mode.

\*3. Continues the recording of the latest measured values until the internal memory reaches its capacity. (If the internal memory capacity exceeds the capacity, data is overwritten from the oldest one in the memory.)

\*4. Output when the range of upper/lower limit of the air flow that has been set in threshold setting mode is exceeded.

\*5. When using a third party SD card, it is recommended to use a reliable and durable industrial SD card (SD standard or SDHC standard (not compliant with SDXC standard), Class 4 or higher, flash memory type SLC or MLC type).

You must confirm the operation of the SD card yourself.

\*6. When using a mounting magnet, be sure to install it in a location where shock is not applied.

\*7. A T-branch connector to connect to D6FZ-FC02.

\*8. OMRON's XW4B-02B1-H1 connector

\*9. Orders for HMC-SD291 will be accepted until the end of March 2022.

# Connection

## Connection diagram

[with 1 sensor]

- ① Single-end wire cable
- ② Double-end connector cable

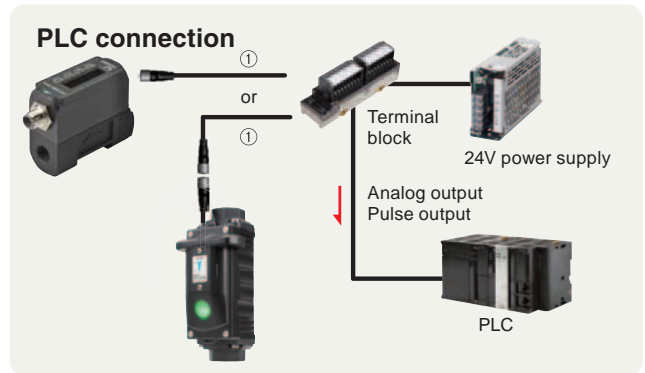
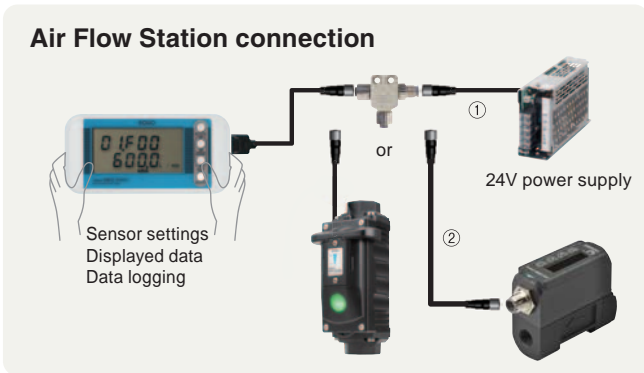

[Data communications with multiple sensor connections]

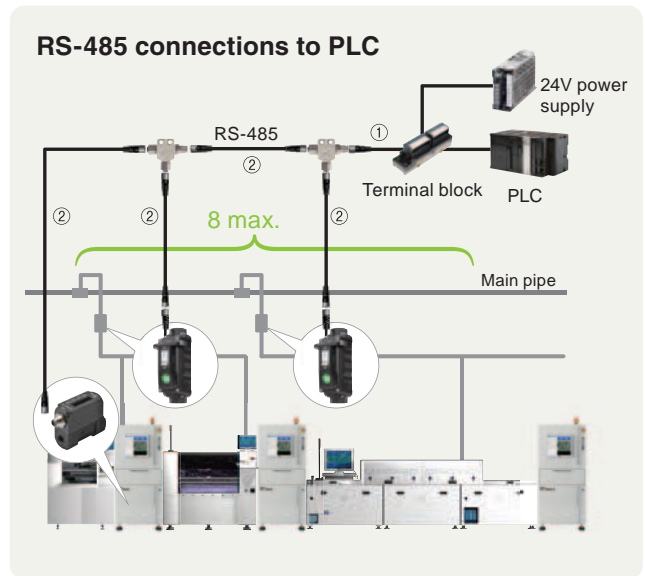
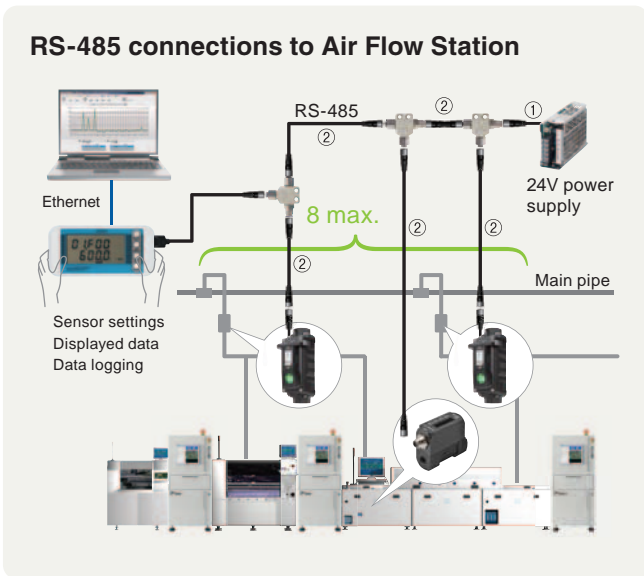

[Wireless Data Collection]

Ethernet  
Wireless Unit Master (LAN)  
WZ-MLAN01  
Wireless Unit Slave (Pulse Count)  
WZ-SP01  
Main pipe  
Connects to up to 2 Sensors.

#### The Triple Reliability of the 920 MHz Band

<p>Compared to the 2.4 GHz band:</p> <p>The reliability of a longer communications distance.</p>	<p>The reliability of easier bending of waves bend around objects.</p>	<p>The reliability of less interference from other communications devices.</p>
--	--	--

For detailed specifications, consult your OMRON sales representative.

Refer to the user's manuals for the Wireless Unit and Air Flow Sensors for detailed information on connections.

# Characteristics data

## Pressure loss\* (typical example)

D6FZ-FGS1000

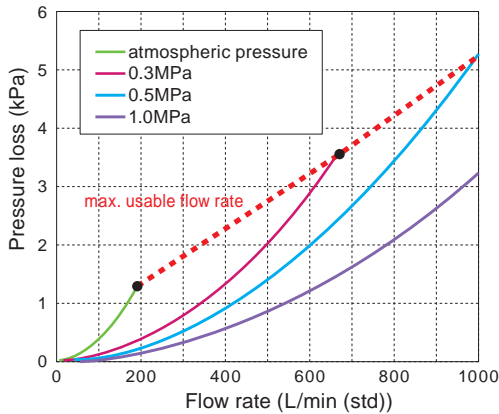

\* Note: With direct piping.

D6FZ-FGT200

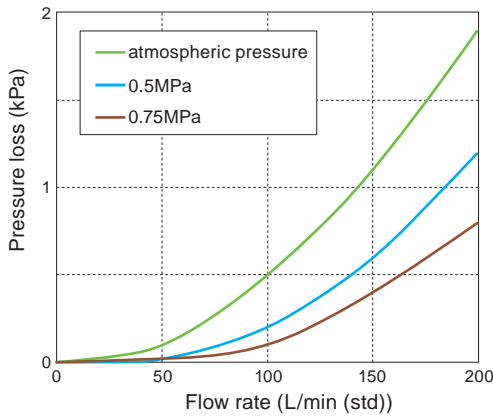

D6FZ-FGT500

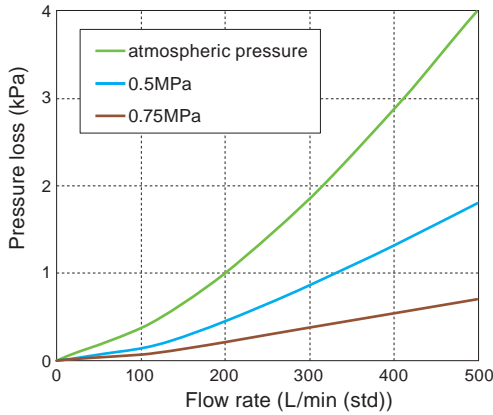

## Min. and max. flow rate conversion table (typical example)

D6FZ-FGS1000

Temperature [°C]	Pressure [MPa]	Min. flow rate [L/min (std)]	Max. flow rate [L/min (std)]
20	0.3	3.96	667.37
	0.5	5.93	999.94
	0.7	7.91	1000.00
25	0.3	3.89	656.17
	0.5	5.83	983.17
	0.7	7.78	1000.00
30	0.3	3.83	645.35
	0.5	5.74	966.96
	0.7	7.65	1000.00

## Flow rate accuracy characteristics for a length of straight pipe

<D6FZ-FGT only>

The following graph shows the flow rate accuracy characteristics for a length of straight pipe (reference information).

D6FZ-FGT200

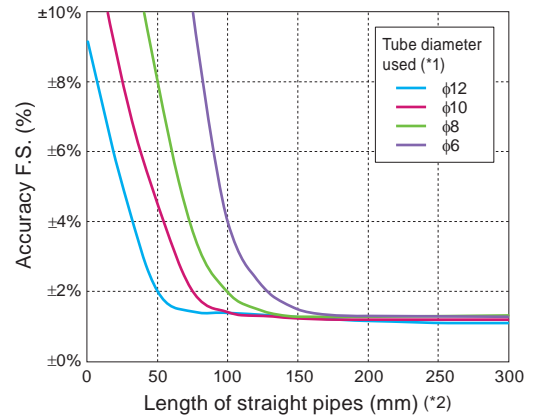

D6FZ-FGT500

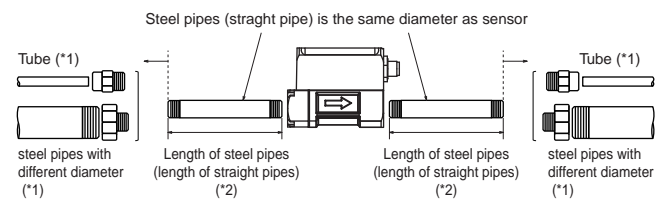
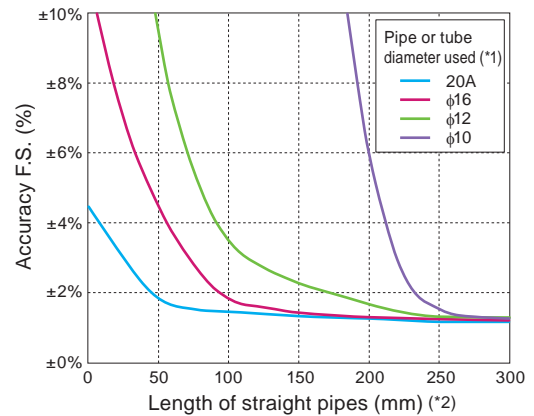

## Safety Precaution

Read the agreement when ordering.

### Air Flow Sensor

#### Warning

This device cannot be used to detect people either directly or indirectly for the purpose of assuring safety.

Do not use the product as a detector for personal safety.



The use of flammable gases may cause explosion.

Do not use the product with flammable gases.



Electric shock may occur. Do not connect the product to a AC power supply.



#### Caution

Do not use in an ambient atmosphere or environment that exceeds the ratings.

Injury may occur due to explosion.

Flow rate and pressure must be within the range of use.



<D6FZ-FGT only>

If water drop, oil, mist and dust flow in the body, it may mismeasurement and destruction. Use clean fluid. Dust and mist can affect the characteristics of Sensor or damage the Sensor. Install a filter and mist separator on the upstream tube. Moreover, install an air flow sensor after removing the dust remaining in pipe by something like air blow.



### Precautions for Correct use

#### Precaution for piping

<D6FZ-FGT only>

Applicable diameter : D6FZ-FGT200 / 8A, D6FZ-FGT500 / 15A

When piping, be sure to use a same diameter steel pipe for the body conduit (straight pipe / elbow).

If piping different diameter pipes or using the fittings for air tubing is required, be sure to use the straight same diameter steel pipes with the body at both ends directly to make measurement accuracy better.

For details to p.12, "Flow rate accuracy characteristics for a length of straight pipe".

#### Precaution for mounting

Mounting position

- Be sure to mount the body horizontally, otherwise the detection accuracy might be worse.
- Don't mount the body facing the control panel downward. Otherwise, the mist and dust in the pipe accumulates and it might cause breakdown.

<Correct mounting>

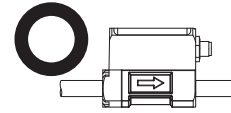

- Mounting the body horizontally
- Control panel Upward

<Incorrect mounting>

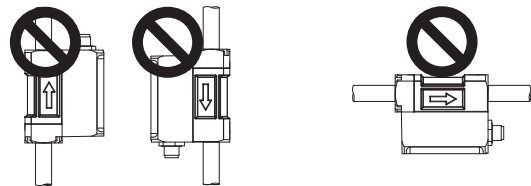

- Mounting the body Vertically
- Control panel Downward

Flowing direction

- An arrow in the side of the body indicates the direction where air flows.
- Be sure to check the direction of the arrow before mounting.
- Mounting in the opposite direction causes mismeasurement.

<The indication of the body>

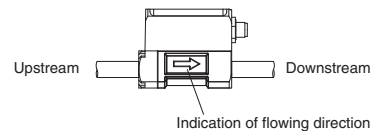

<The relationship between flowing direction and mounting direction>

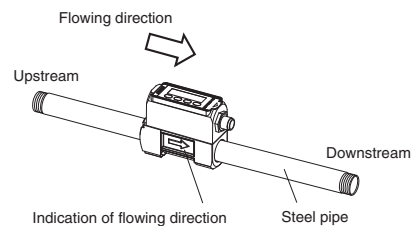

### Air Flow Station

#### Warning

The mounting magnets provided with the product have strong magnetism. If the product is mounted using these magnets, anyone wearing a heart pacemaker must not operate the product; or the product must not be in proximity of such a person.



This product contains lithium batteries. Serious injury may occur due to fire or explosion. Do not attempt to disassemble the product, deform it by applying pressure, heat it in a high temperature (100°C or more), or burn it for disposal.



# Dimensions

For products with the **CAD data** mark, the data for the 2-dimensional CAD drawings and 3-dimensional models is available. The CAD data can be downloaded at [www.fa.omron.co.jp](http://www.fa.omron.co.jp).

(unit: mm)  
Unspecified dimensions tolerances: Tolerance class IT16

## Air Flow Sensor D6FZ-FGT200

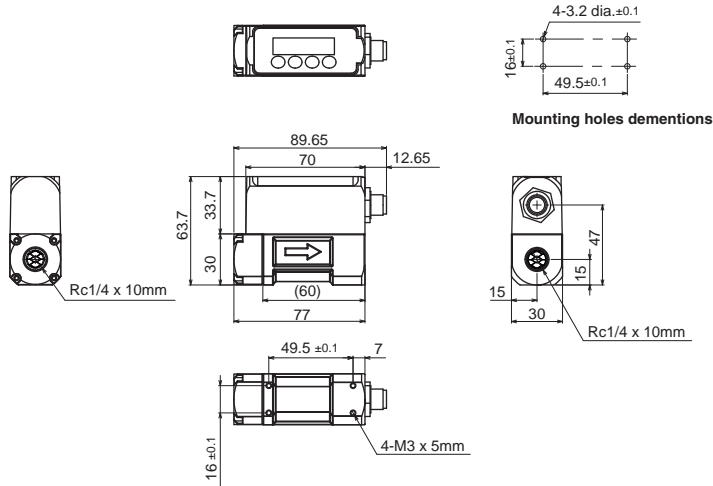

## D6FZ-FGT500

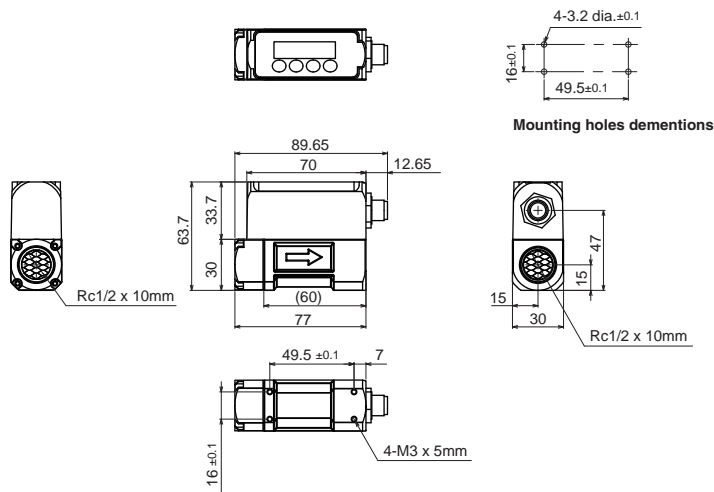

## D6FZ-FGS1000

**CAD data**

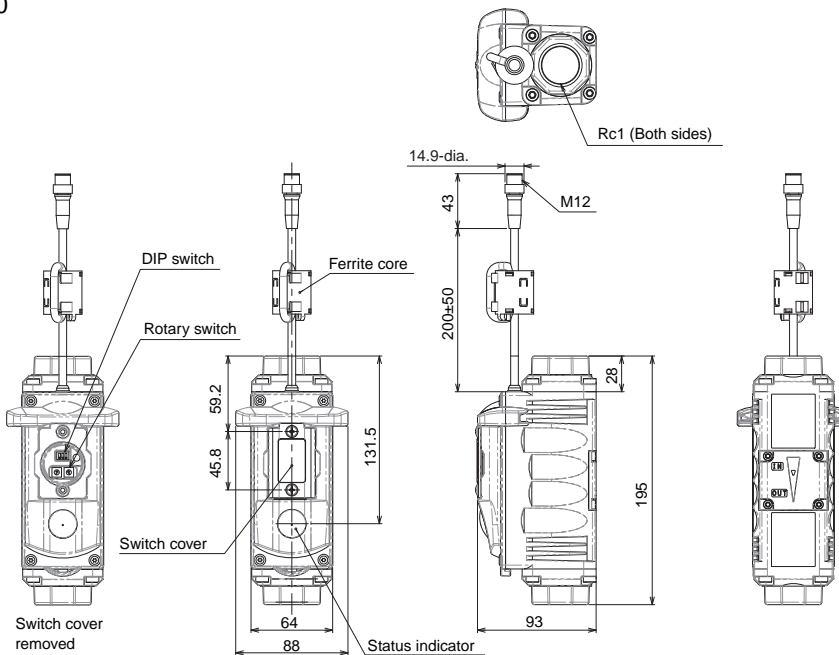

**Air Flow Station**  
D6FZ-FGX21

**CAD data**

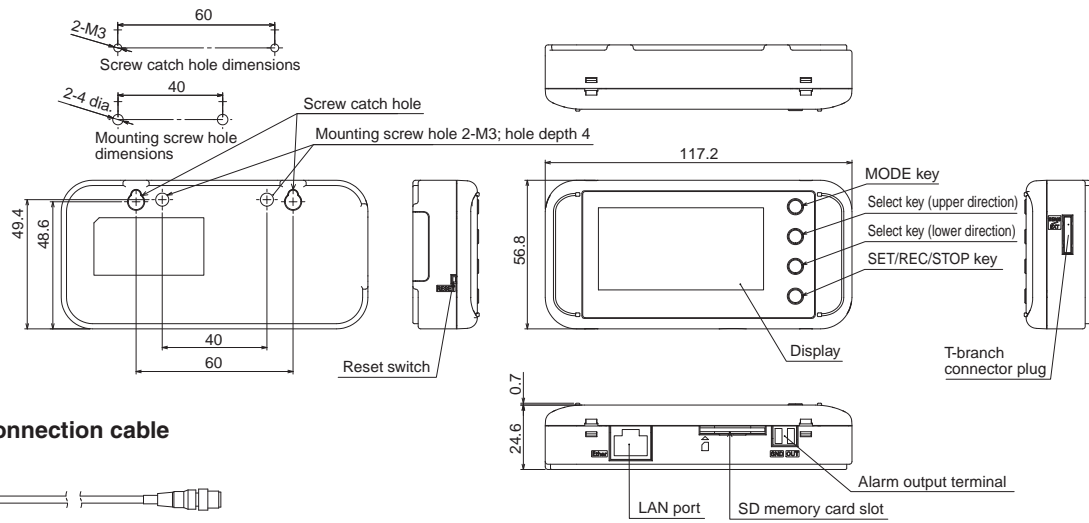

**T-branch connection cable**

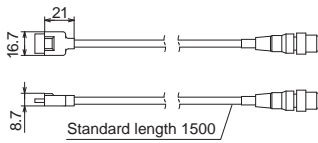

**T-branch connector**  
D6FZ-FC02

**CAD data**

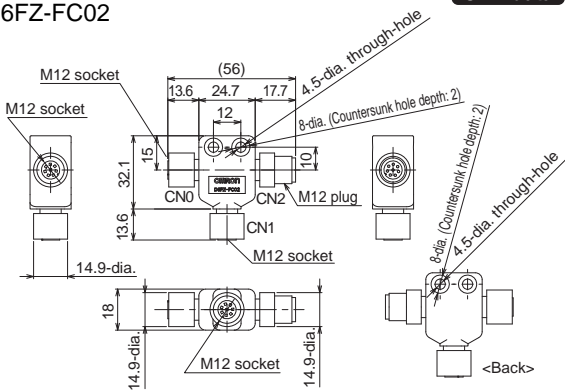

**Single-end wire cable**

- D6FZ-JD3A (L=3m)
- D6FZ-JD10A (L=10m)
- D6FZ-JD20A (L=20m)

**CAD data**

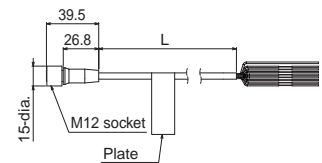

**Double-end connector cable**

- D6FZ-JD3B (L=3m)
- D6FZ-JD5B (L=5m)
- D6FZ-JD10B (L=10m)
- D6FZ-JD20B (L=20m)

**CAD data**

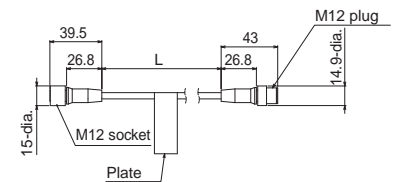

**Mounting bracket**  
D6FZ-FC03

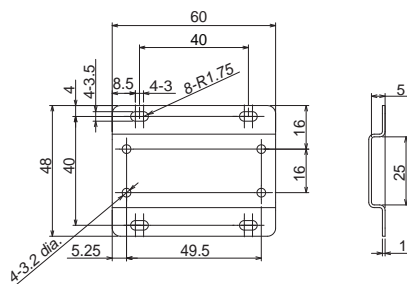





# Terms and Conditions Agreement

## Read and understand this catalog.

Please read and understand this catalog before purchasing the products. Please consult your OMRON representative if you have any questions or comments.

## Warranties.

(a) Exclusive Warranty. Omron's exclusive warranty is that the Products will be free from defects in materials and workmanship for a period of twelve months from the date of sale by Omron (or such other period expressed in writing by Omron). Omron disclaims all other warranties, express or implied.

(b) Limitations. OMRON MAKES NO WARRANTY OR REPRESENTATION, EXPRESS OR IMPLIED, ABOUT NON-INFRINGEMENT, MERCHANTABILITY OR FITNESS FOR A PARTICULAR PURPOSE OF THE PRODUCTS. BUYER ACKNOWLEDGES THAT IT ALONE HAS DETERMINED THAT THE PRODUCTS WILL SUITABLY MEET THE REQUIREMENTS OF THEIR INTENDED USE.

Omron further disclaims all warranties and responsibility of any type for claims or expenses based on infringement by the Products or otherwise of any intellectual property right. (c) Buyer Remedy. Omron's sole obligation hereunder shall be, at Omron's election, to (i) replace (in the form originally shipped with Buyer responsible for labor charges for removal or replacement thereof) the non-complying Product, (ii) repair the non-complying Product, or (iii) repay or credit Buyer an amount equal to the purchase price of the non-complying Product; provided that in no event shall Omron be responsible for warranty, repair, indemnity or any other claims or expenses regarding the Products unless Omron's analysis confirms that the Products were properly handled, stored, installed and maintained and not subject to contamination, abuse, misuse or inappropriate modification. Return of any Products by Buyer must be approved in writing by Omron before shipment. Omron Companies shall not be liable for the suitability or unsuitability or the results from the use of Products in combination with any electrical or electronic components, circuits, system assemblies or any other materials or substances or environments. Any advice, recommendations or information given orally or in writing, are not to be construed as an amendment or addition to the above warranty.

See <http://www.omron.com/global/> or contact your Omron representative for published information.

## Limitation on Liability; Etc.

OMRON COMPANIES SHALL NOT BE LIABLE FOR SPECIAL, INDIRECT, INCIDENTAL, OR CONSEQUENTIAL DAMAGES, LOSS OF PROFITS OR PRODUCTION OR COMMERCIAL LOSS IN ANY WAY CONNECTED WITH THE PRODUCTS, WHETHER SUCH CLAIM IS BASED IN CONTRACT, WARRANTY, NEGLIGENCE OR STRICT LIABILITY.

Further, in no event shall liability of Omron Companies exceed the individual price of the Product on which liability is asserted.

## Suitability of Use.

Omron Companies shall not be responsible for conformity with any standards, codes or regulations which apply to the combination of the Product in the Buyer's application or use of the Product. At Buyer's request, Omron will provide applicable third party certification documents identifying ratings and limitations of use which apply to the Product. This information by itself is not sufficient for a complete determination of the suitability of the Product in combination with the end product, machine, system, or other application or use. Buyer shall be solely responsible for determining appropriateness of the particular Product with respect to Buyer's application, product or system. Buyer shall take application responsibility in all cases.

NEVER USE THE PRODUCT FOR AN APPLICATION INVOLVING SERIOUS RISK TO LIFE OR PROPERTY OR IN LARGE QUANTITIES WITHOUT ENSURING THAT THE SYSTEM AS A WHOLE HAS BEEN DESIGNED TO ADDRESS THE RISKS, AND THAT THE OMRON PRODUCT(S) IS PROPERLY RATED AND INSTALLED FOR THE INTENDED USE WITHIN THE OVERALL EQUIPMENT OR SYSTEM.

## Programmable Products.

Omron Companies shall not be responsible for the user's programming of a programmable Product, or any consequence thereof.

## Performance Data.

Data presented in Omron Company websites, catalogs and other materials is provided as a guide for the user in determining suitability and does not constitute a warranty. It may represent the result of Omron's test conditions, and the user must correlate it to actual application requirements. Actual performance is subject to the Omron's Warranty and Limitations of Liability.

## Change in Specifications.

Product specifications and accessories may be changed at any time based on improvements and other reasons. It is our practice to change part numbers when published ratings or features are changed, or when significant construction changes are made. However, some specifications of the Product may be changed without any notice. When in doubt, special part numbers may be assigned to fix or establish key specifications for your application. Please consult with your Omron's representative at any time to confirm actual specifications of purchased Product.

## Errors and Omissions.

Information presented by Omron Companies has been checked and is believed to be accurate; however, no responsibility is assumed for clerical, typographical or proofreading errors or omissions.

\* EQUO is trademark of OMRON Corporation in Japan and other countries.

\* Microsoft and Windows are registered trademarks of Microsoft Corporation in the United States and other countries.

**OMRON Corporation** Industrial Automation Company  
Tokyo, JAPAN

Contact: [www.ia.omron.com](http://www.ia.omron.com)

### **Regional Headquarters**

**OMRON EUROPE B.V.**  
**Sensor Business Unit**  
Carl-Benz-Str. 4, D-71154 Nufringen, Germany  
Tel: (49) 7032-811-0/Fax: (49) 7032-811-199

**OMRON ASIA PACIFIC PTE. LTD.**  
No. 438A Alexandra Road # 05-05/08 (Lobby 2),  
Alexandra Technopark,  
Singapore 119967  
Tel: (65) 6835-3011/Fax: (65) 6835-2711

**OMRON ELECTRONICS LLC**  
2895 Greenspoint Parkway, Suite 200  
Hoffman Estates, IL 60169 U.S.A  
Tel: (1) 847-843-7900/Fax: (1) 847-843-7787

**OMRON (CHINA) CO., LTD.**  
Room 2211, Bank of China Tower,  
200 Yin Cheng Zhong Road,  
PuDong New Area, Shanghai, 200120, China  
Tel: (86) 21-5037-2222/Fax: (86) 21-5037-2200

**Authorized Distributor:**

© OMRON Corporation 2013-2021 All Rights Reserved.  
In the interest of product improvement,  
specifications are subject to change without notice.

**CSM\_10\_1**  
**Cat. No. F091-E1-04**

1121(0813)