

Model **FL-STC**

FL series Lighting for Image Processing Lighting Controller

INSTRUCTION SHEET

Thank you for selecting OMRON product. This sheet primarily describes precautions required in installing and operating the product.

Before operating the product, read the sheet thoroughly to acquire sufficient knowledge of the product. For your convenience, keep the sheet at your disposal.

TRACEABILITY INFORMATION:

Importer in EU
Omron Europe B.V.
Wegalaan 67-69
2132 JD Hoofddorp,
The Netherlands

Manufacturer
Omron Corporation,
Shiojiri Horikawa, Shimogyo-ku,
Kyoto, 600-8530 JAPAN

The following notice applies only to products that carry the CE mark:
Notice:
This is a class A product. In residential areas it may cause radio interference, in which case the user may be required to take adequate measures to reduce interference.

Regulation of KC marking
Please see the following URL for Korean KC mark compliance information.
http://www.rro.go.kr/selfform/OMR-FL-STC

2155411-6G

© OMRON Corporation 2011-2025 All Rights Reserved. ②

1.Specifications

Model	Lighting Controller 1CH type		Lighting Controller 2CH type	
I/O type	NPN	PNP	NPN	PNP
Model Name	FL-STC10	FL-STC15	FL-STC20	FL-STC25
Power Supply Voltage	DC24V±10%(Including ripple)			
Current Consumption	MAX 36W,1.5A(Lighting Included)		MAX 72W,3A(Lighting Included)	
Lighting Channel	1		2	
Applicable Lighting	FL-□ series			
Luminance Control Method	Lighting ON continuously. PWM frequency:100KHz,Control step:400 steps			
Method	EXTERNAL TRIGGER mode	Lighting ON synchronized with external trigger "During the TRIG signal ON" or "0.1 to 99.9ms"		
	TRIGGER mode	PWM frequency:100KHz,Control step:400 steps		
	STOROB mode	Lighting ON synchronized with external trigger (more than 2 times brighter than EXTERNAL TRIGGER mode) Lighting time:0.01 to 5ms		
Luminance Key	Slide SW and Direction key setting			
Adjustment I/O	9bit binary input control			
External Interface	Parallel I/O connector(mini D-SUB 15 PIN) Terminal block(External Trigger 1CH/2CH, power supply)			
Dielectric Strength	AC1000V 50/60Hz 1min			
Insulation Resistance	20MΩ(100VDC)			
Ambient Temperature	Operating: 0 to 40°C, Storage: -15 to +60°C (with no icing or condensation)			
Ambient Humidity	Operating and storage: 35% to 85% (with no condensation)			
Vibration Resistance(destructive)	10 to 150 Hz, (0.7mm double amplitude) 80 min each in X, Y, and Z directions			
Shock Resistance (destructive)	150 m/s ² 3 times each in 6 directions(up/down, left/right, forward/backward)			
Materials	Polycarbonate			
Degree of Protection	IEC60259 IP20			
Weight	Main unit:100g, Packed state:170g			
Accessories	Instruction sheet,Terminal block connector			

2.Installation

■ Fix to DIN rail

Put on and take off from DIN rail with one-touch operation.

- 1) Put on
 - Hook on the DIN rail
 - Push controller until the click sound
- 2) Take off
 - Pull hook to the outside
 - Lift controller from DIN rail



Attention

Fix the controller by End Plate

Dimensions from DIN rail

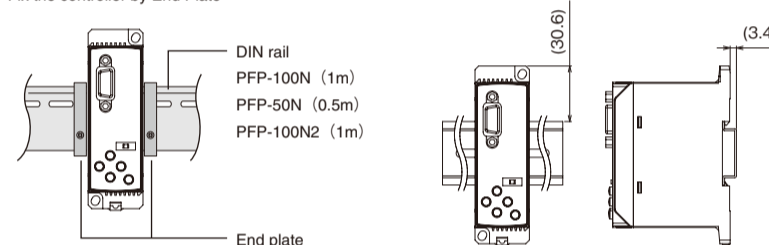

■ Fix by screw

It can be fixed by 2pcs of M4 screw. Fasten torque : within 0.49n/m

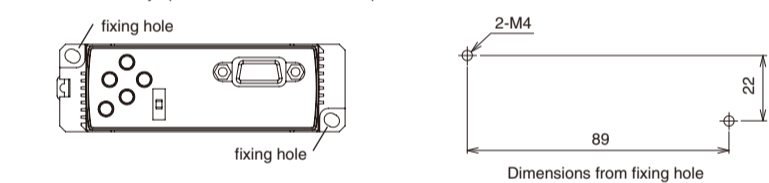

3.How to connect to light

■ Insert

Adapt the boss of lighting cable and channel mark of controller. Insert cable to the controller until the click sound.

- (1) 1CH type
- (2) 2CH type

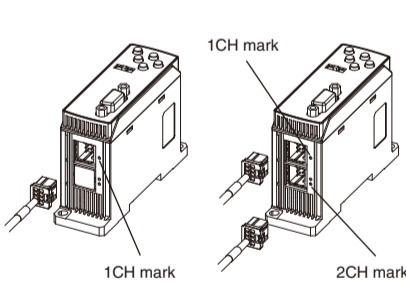

■ Release

Pull connector with pushing the boss

Attention

Do not pull cable without pushing boss. Disconnection might happen.

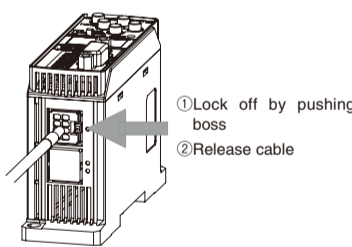

Attention

Avoid to touch the terminals

PRECAUTIONS ON SAFETY

● Meanings of Signal Words

CAUTION Indicates a potentially hazardous situation which, if not avoided, may result in minor or moderate injury or in property damage.

● Alert statements

CAUTION

Do not use it exceeding the rated voltage. There is a possibility of failure and fire.

Do not connect amplifier units to AC power supply. Risk of explosion.

Indicates prohibition when there is a risk of minor injury from electrical shock or other source if the product is disassembled.

PRECAUTIONS FOR SAFE USE

Please observe the following precautions for safe use of the products.

1.Installation Environment

- Do not use the product in environments where it can be exposed to inflammable/explosive gas.
- To secure the safety of operation and maintenance, do not install the product close to high-voltage devices and power devices.

2.Power Supply and Wiring

- The supply voltage must be within the rated range (DC21.6 to 26.4V including ripple 10%(peak to peak)).
- Reverse connection of power supply is not allowed. Connection to AC power supplies also not allowed.
- Open-collector outputs should not be short-circuited.
- High-Voltage lines and power lines must be wired separately from this product. Wiring them together or placing them in the same duct may cause induction, resulting in malfunction or damage.
- Always turn off the power of the unit before connecting or disconnecting cables.

3.Other Rules

- Do not use for safety circuit for human safe and nuclear power.
- Do not attempt to disassemble, deform by pressure, incinerate, repair, or modify this product.
- When disposing of the product, treat as industrial waste.
- If you notice an abnormal condition such as a strange odor, extreme heating of the unit, or smoke, immediately stop using the product, turn off the power, and consult your dealer.

4. Regulations and Standards

This product is compliant with the standards below:
EN Standards(European Standards), EN61326-1
Electromagnetic environment : Industrial electromagnetic environment (EN/IEC 61326-1 Table 2)

Also, the following condition is applied to the immunity test of this product.
: There may be cases that Lighting brightness fluctuate Max 10%.

PRECAUTIONS FOR CORRECT USE

Please observe the following precautions to prevent failure to operate, malfunctions, or undesirable effects on product performance.

1.Do not install the product in locations subjected to the following conditions:

- Ambient temperature outside the rating
- Rapid temperature fluctuations
- Relative humidity outside the range of 35 to 85%
- Presence of corrosive or flammable gases
- Presence of dust, salt, or iron particles
- Direct vibration or shock
- Reflection of intense light (such as other laser beams, electric arc-welding machines, or ultra-violet light)
- Direct sunlight or near heaters
- Water, oil, or chemical fumes or spray, or mist atmospheres
- Strong magnetic or electric field

2.Power Supply and Wiring

- Connect lightings and I/O lines first, then supply voltage source.
- If surge currents are present in the power lines, connect surge absorbers that suit the operating environment.
- Before turning ON the power after the product is connected, make sure that the power supply voltage is correct, there are no incorrect connections (e.g. load short-circuit) and the load current is appropriate. Incorrect wiring may result in break down of the product.
- Use FL-XC cable to extend the cable length between lightings and lighting controller. FL-XC can be used only one unit at the same time. Do not connect FL-XC and FL-XC each other.

3.Maintenance and inspection

- Prevent from high pressure instruments and driving machines for safety of operation and maintenance.
- Always turn off the power of the unit before connecting or disconnecting cables.
- Do not use thinners, benzene, acetone, kerosene to clean the Product.

5.Part Names and Functions

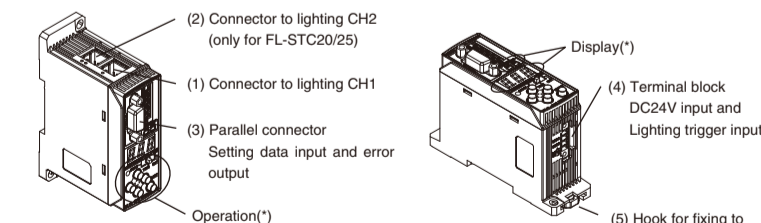

(*)Operation and Display

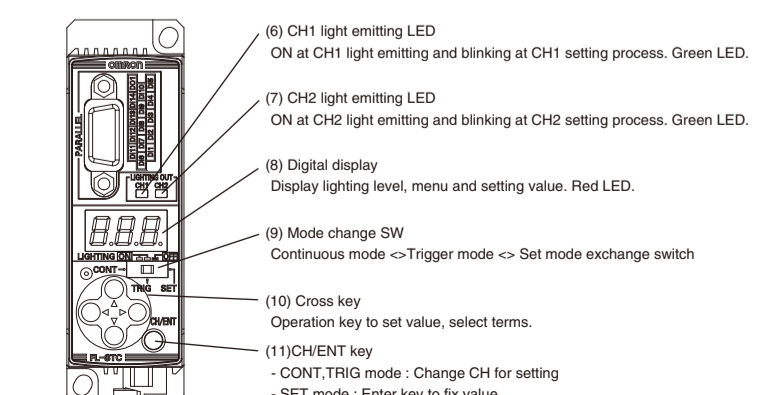

4.Wiring

Attention

Wire correctly, otherwise, it would be breakdown

■ Fix terminal block

1. Release terminal block by unfixing 2 screws.
2. Fix the wire to the terminal block by minus screw fasten torque :0.22 - 0.25Nm
3. Insert male connector to female connector.
4. Fix the male connector by screw fasten torque:0.22-0.25Nm

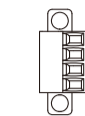
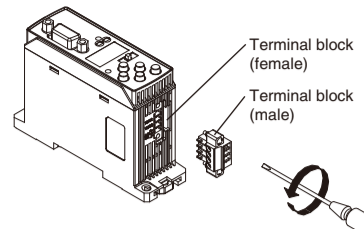

PIN No.	Signal	I/O	Function
1	TRIG1	Input	Trigger input for CH1(*)
2	TRIG2	Input	Trigger input for CH2(*)
3	24VDC	Input	Power Supply(24VDC)
4	0V	Input	Power Supply(0V)

Attention

- Use power supply DC24 (21.6 -26.4V) for 3 and 4 pin.
- Supply voltage from safety voltage circuit. Use UL class 2 direct-current power source if UL approval needed.

* D13 and D14 of parallel connector has Lighting trigger. Make sure isolate another trigger terminal when you use one trigger terminal.

■ Parallel Connector

Parallel Connector (mini D-SUB 15 pin (female))

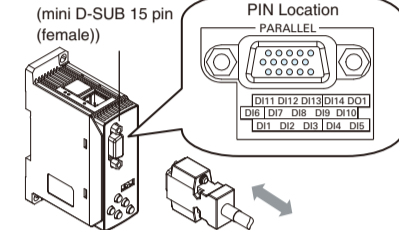

※ Assembled product
FL-XCP2(Cable length:2m)

PIN No.	Signal	I/O	Function	min-Input Time
D11	D1	Input	Data 1bit(low)	1) CONT/TRIG mode Set Luminance value by D9 - D1, 9bit binary data. Range 1 - 400 (binary 00000001 - 11001000) 2) STB mode Set Strobe Lighting time by D9 - D1, 9bit binary data. Range 0.01 - 5.00ms (1 - 500 binary 00000001 - 11110100) Each bit 1=ON, 0=OFF
D12	D2	Input	Data 2bit	
D13	D3	Input	Data 3bit	
D14	D4	Input	Data 4bit	
D15	D5	Input	Data 5bit	
D16	D6	Input	Data 6bit	
D17	D7	Input	Data 7bit	
D18	D8	Input	Data 8bit	
D19	D9	Input	Data 9bit(High)	
D10	CLR	Input	Error clear. (OFF⇒ON timing)	0.5
DI11	SEL	Input	Select setting CH. OFF=1CH, ON=2CH	(*3)
DI12	SAVE	Input	Save data D9 - D1 to memory at the timing of "save" OFF⇒ON(*4)	0.5
DI13	TRIG1	Input	CH1 Trigger Input (*1)(*2)	0.02
DI14	TRIG2	Input	CH2 Trigger Input (*1)(*2)	0.02
DO1	ERR	Output	ON at the Error happens	-

(*1) 1 and 2pin of terminal block have Lighting trigger. Make sure isolate another trigger terminal when you use one trigger terminal.

(*2) Prevent from chattering, otherwise the lighting timing would be missed.

(*3) see "8. lighting level setting by parallel input"

(*4) Memory function "ON": The data stored in FLASH memory .

Memory function "OFF": The data stored in RAM memory .

For more information please refer to "7. Setting "

Attention

Input signal more than MIN input time (ms). Otherwise the signal would not be recognized.

■ I/O circuit

· NPN(FL-STC20/10)

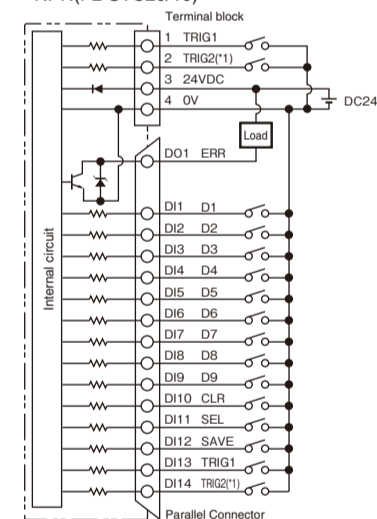

(*1) no use for FL-STC10

· PNP(FL-STC25/15)

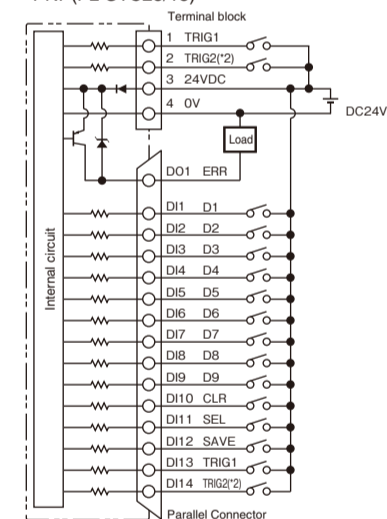

(*2) no use for FL-STC15

Electric Specifications

Item	NPN type(FL-STC20/10)	PNP type(FL-STC25/15)
Output	NPN Open-collector 30VDC 50mA max. ON:residual voltage 1.2V max. OFF:leakage current 0.1mA max.	PNP Open-collector 50mA max. ON:residual voltage 1.2V max. OFF:leakage current 0.1mA max.
Input	ON:Short-circuited with 0V or 1.5V or less OFF:Open(leakage current:0.1mA max.)	ON:Supply voltage short-circuited or supply voltage within 1.5v OFF:Open(leakage current:0.1mA max.)

Attention

Connect I/O ground to power supply ground.

6.Dimensions

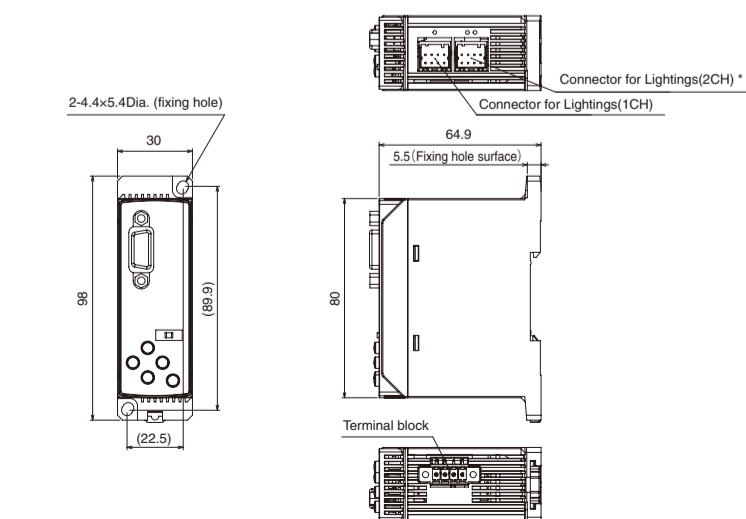

* FL-STC10/15 don't have 2CH connector.

(UNIT:mm)

7. Setting

Mode selection

3 mode for lighting. Use certain one you want.

- (1) CONTINUOUS mode (CONT) : continuously lighting
- (2) EXTERNAL TRIGGER mode (TRIG) : lighting by trigger input
- (3) STROBE mode (STB) : lighting 2 times brighter by trigger input

Lighting condition setting for each mode

(1) CONTINUOUS mode (CONT)

- Mode change SW to "CONT"

- Lighting level setting

Set by cross key to change digital value. 400 steps from 1(MIN) -399 to ALL(MAX).

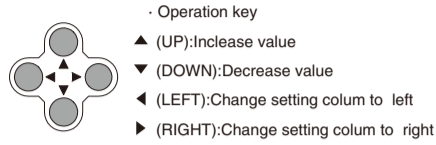

- Changing CH

Setting CH changes when CH/ENT key is pushed CH1<->CH2. After push CH/ENT key, CH number is displayed 1sec.



- Digital value changes by pushing operation key. This value is synchronized with light intensity in real time. Adjust value with checking light intensity.



Attention

- After changing value, when 5 sec have passed with no operation, the value is saved automatically.

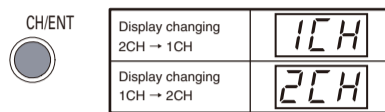

(2) EXTERNAL TRIGGER mode (TRIG)

- Mode change SW to "TRIG"

- Lighting level setting

Set by cross key to change digital value. 400 steps from 1(MIN) -399 to ALL(MAX).

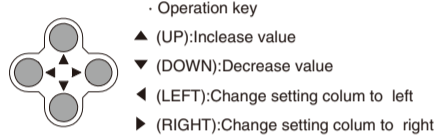

- Changing CH

Setting CH changes when CH/ENT key is pushed CH1<->CH2. After push CH/ENT key, CH number is displayed 1sec.



- Digital value changes by pushing operation key. This value is synchronized with light intensity in real time. Adjust value with checking light intensity.



Attention

- After changing value, when 5 sec have passed with no operation, the value is saved automatically.

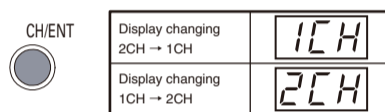

- Timing chart (TRIG mode)

The light is emitting by external trigger as the chart.

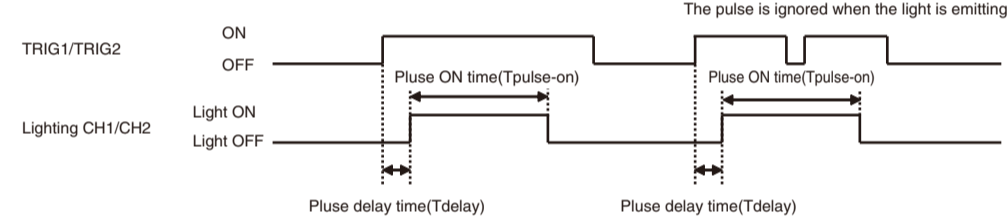

- Emission delay : 0 - 999ms by 1ms (default 0ms) *

- Emission time : 0.1ms - 99.9ms by 0.1ms (default ALL)

ALL : light emitting as long as the trigger is ON

* Emission delay and Emission time can be set in SET mode.

Attention

Do not look straight to lightings when changing mode SW. The lightings flashes when the mode SW is changed CONT ⇒ TRIG or SET ⇒ TRIG.

9. Lighting level setting by parallel input

The following setting is possible by parallel input.

- 1) CONT mode and TRIG mode : light intensity value change
- 2) STB mode : Strobe emission time

Process of parallel input

- Input D1 - D9 binary data

- Select CH by SEL input

- The value will be fixed by SAVE input.

- Timing chart

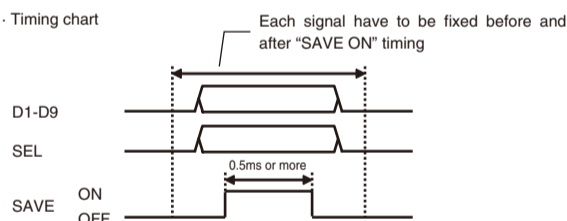

PIN No.	Signal	I/O	Function
D1	D1	Input	Data 1bit(low)
D2	D2	Input	Data 2bit
D3	D3	Input	Data 3bit
D4	D4	Input	Data 4bit
D5	D5	Input	Data 5bit
D6	D6	Input	Data 6bit
D7	D7	Input	Data 7bit
D8	D8	Input	Data 8bit
D9	D9	Input	Data 9bit(High)
D11	SEL	Input	CH select(OFF:CH1_ON:CH2)
D12	SAVE	Input	Memory function "ON": The data stored in FLASH memory . Memory function "OFF": The data stored in RAM memory . For more information please refer to "7. Setting"

Important

Do not input TRIG1/2 during setting by parallel input. Make sure the timing is correct.

11. Error message

Error message list and way to recover

Display	Reason of error	Behavior	Way to recover
Er1	Over current at CH1	- Stop light emission - Error output ON (parallel DO1:ERR)	- Shutdown the controller (power supply) and check the light condition and wiring. Then restart controller. * If everything is correct but error happens, the product (light or controller) would be defected.
Er2	Over current at CH2	- Stop light emission - Error output ON (parallel DO1:ERR)	
Er3	Over current at CH1 and CH2	- Stop light emission - Error output ON (parallel DO1:ERR)	
Er4	Wright error by parallel input	- Stop light emission - Error output ON (parallel DO1:ERR)	- Input Error Clear (parallel DI10:CLR) * After error clear, try again with correct timing
Er5	No light connected in CH1	- Stop light emission - Error output ON (parallel DO1:ERR)	- Shutdown the controller (power supply) and check the light condition and wiring. Then restart controller.
Er6	No light connected	- Stop light emission - Error output ON (parallel DO1:ERR)	- Shutdown the controller (power supply) and check the light condition and wiring. Then restart controller.
Er7	Over voltage from power supply	- Stop light emission - Error output ON (parallel DO1:ERR)	- Shutdown the controller (power supply) and check the light condition and wiring. Then restart controller.

1) Change Mode change SW to "SET"



2) Set according to the setting flow

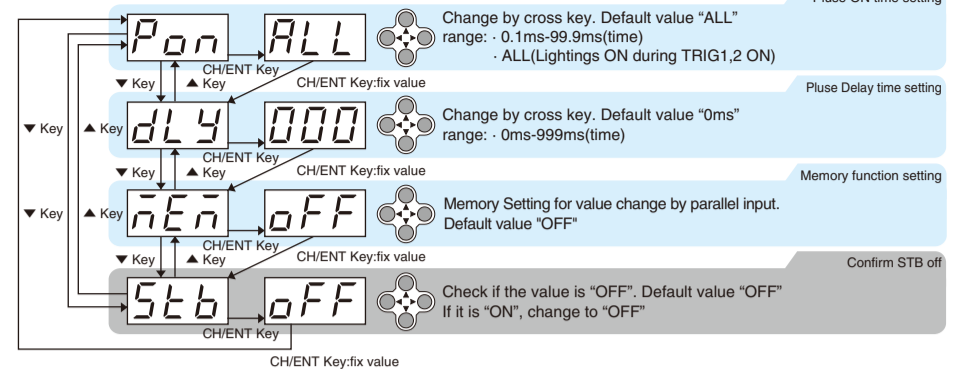

3) Change Mode change SW to "TRIG"



(3) STROBE mode

- Change to STROBE mode by 1) to 3) process

1) Change Mode change SW to "SET"



2) Set according to the setting flow

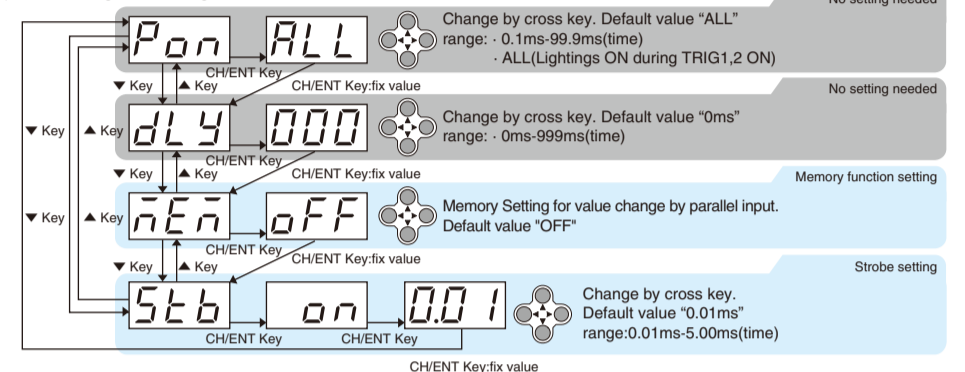

3) Change Mode change SW to "TRIG", "Stb" is displayed if succeeded.

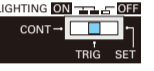

(* "stb" is displayed at the TRIG SW.



Important

With 2CH controller, each CH have to be same mode. If one CH is set to STB mode. The other CH is automatically set to STB mode.

- Changing CH

Setting CH changes when CH/ENT key is pushed CH1<->CH2. After push CH/ENT key, CH number is displayed 1sec.

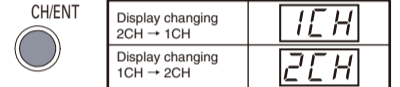

- Timing chart (STB mode)

The light is emitting with external trigger as the chart.

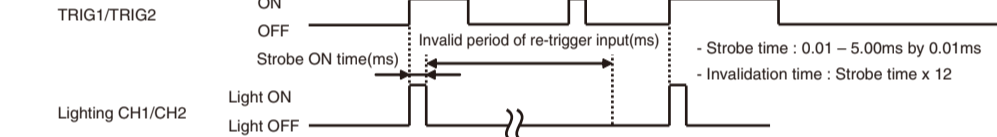

Attention

Do not look straight to lightings when changing mode SW. The lightings flashes when the mode SW is changed CONT ⇒ TRIG or SET ⇒ TRIG.

8. Memory function (MEM)

This function applies only when using the external control.

"ON": The data stored in FLASH(nonvolatile) memory.

Keep data even when the power turned off. 2 sec required for data saving. Make interval at least 2 sec between "SAVE" signal and next "TRIG" signal.

"OFF": The data stored in RAM(volatile) memory.

Return to the last saving data when the power is turned off.

- Timing chart

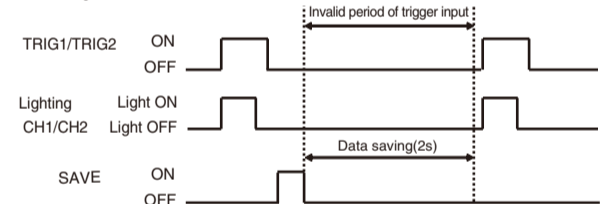

10. Key lock function

Key lock function setting

Whole settings are locked by pushing CH/ENT key 5 sec at CONT or TRIG mode

In Key lock condition, only the the Light intensity value display for each CH can be changed by CH/ENT key.



CH/ENT

Keep push 5sec



Key lock ON
The dot displayed lower right

Release Key lock

Push CH/ENT 5 sec



CH/ENT

Keep push 5sec



Key lock OFF
The dot disappeared

Suitability for Use

Omron Companies shall not be responsible for conformity with any standards, codes or regulations which apply to the combination of the Product in the Buyer's application or use of the Product. At Buyer's request, Omron will provide applicable third party certification documents identifying ratings and limitations of use which apply to the Product. This information by itself is not sufficient for a complete determination of the suitability of the Product in combination with the end product, machine, system, or other application or use. Buyer shall be solely responsible for determining appropriateness of the particular Product with respect to Buyer's application, product or system. Buyer shall take application responsibility in all cases.

NEVER USE THE PRODUCT FOR AN APPLICATION INVOLVING SERIOUS RISK TO LIFE OR PROPERTY WITHOUT ENSURING THAT THE SYSTEM AS A WHOLE HAS BEEN DESIGNED TO ADDRESS THE RISKS, AND THAT THE OMRON PRODUCT(S) IS PROPERLY RATED AND INSTALLED FOR THE INTENDED USE WITHIN THE OVERALL EQUIPMENT OR SYSTEM.

OMRON Corporation Industrial Automation Company
Kyoto, JAPAN Contact: www.ia.omron.com

Regional Headquarters

■ **OMRON EUROPE B.V.**
Wegalaan 67-69, 2132 JD Hoofddorp
The Netherlands
Tel: (31)2356-81-300/Fax: (31)2356-81-388

■ **OMRON ELECTRONICS LLC**
2895 Greenspoint Parkway, Suite 200
Hoffman Estates, IL 60169 U.S.A.
Tel: (1) 847-843-7900/Fax: (1) 847-843-7787

■ **OMRON ASIA PACIFIC PTE. LTD.**
438B Alexandra Road, #08-01/02 Alexandra
Technopark, Singapore 119968
Tel: (65) 6835-3011 / Fax: (65) 6835-3011

■ **OMRON (CHINA) CO., LTD.**
Room 2211, Bank of China Tower,
200 Yin Cheng Zhong Road,
PuDong New Area, Shanghai, 200120, China
Tel: (86) 21-6023-0333 / Fax: (86) 21-5037-2388

© Dec, 2024