



Automation Control Environment (ACE) Version 4

Camera Configuration

User's Manual

NOTE

All rights reserved. No part of this publication may be reproduced, stored in a retrieval system, or transmitted, in any form, or by any means, mechanical, electronic, photocopying, recording, or otherwise, without the prior written permission of OMRON.

No patent liability is assumed with respect to the use of the information contained herein. Moreover, because OMRON is constantly striving to improve its high-quality products, the information contained in this manual is subject to change without notice. Every precaution has been taken in the preparation of this manual. Nevertheless, OMRON assumes no responsibility for errors or omissions. Neither is any liability assumed for damages resulting from the use of the information contained in this publication.

Trademarks

Company names and product names in this document are the trademarks or registered trademarks of their respective companies.

Copyrights

Microsoft product screen shots reprinted with permission from Microsoft Corporation.

Introduction

Thank you for purchasing an OMRON camera.

This manual is OMRON's original instructions describing the setup, operations, and user maintenance of the product.

Please read this manual and make sure you understand the functionality and performance of the ACE software and supported cameras before attempting to use them.

Keep this manual in a safe place where it will be available for reference during operation.

Intended Audience

This manual is intended for the following personnel, who must also have knowledge of factory automation (FA) systems and robotic control methods.

- Personnel in charge of introducing FA systems.
- Personnel in charge of designing FA systems.
- Personnel in charge of installing and maintaining FA systems.
- Personnel in charge of managing FA systems and facilities.

Manual Information

Page Structure

The following page structure is used in this manual.

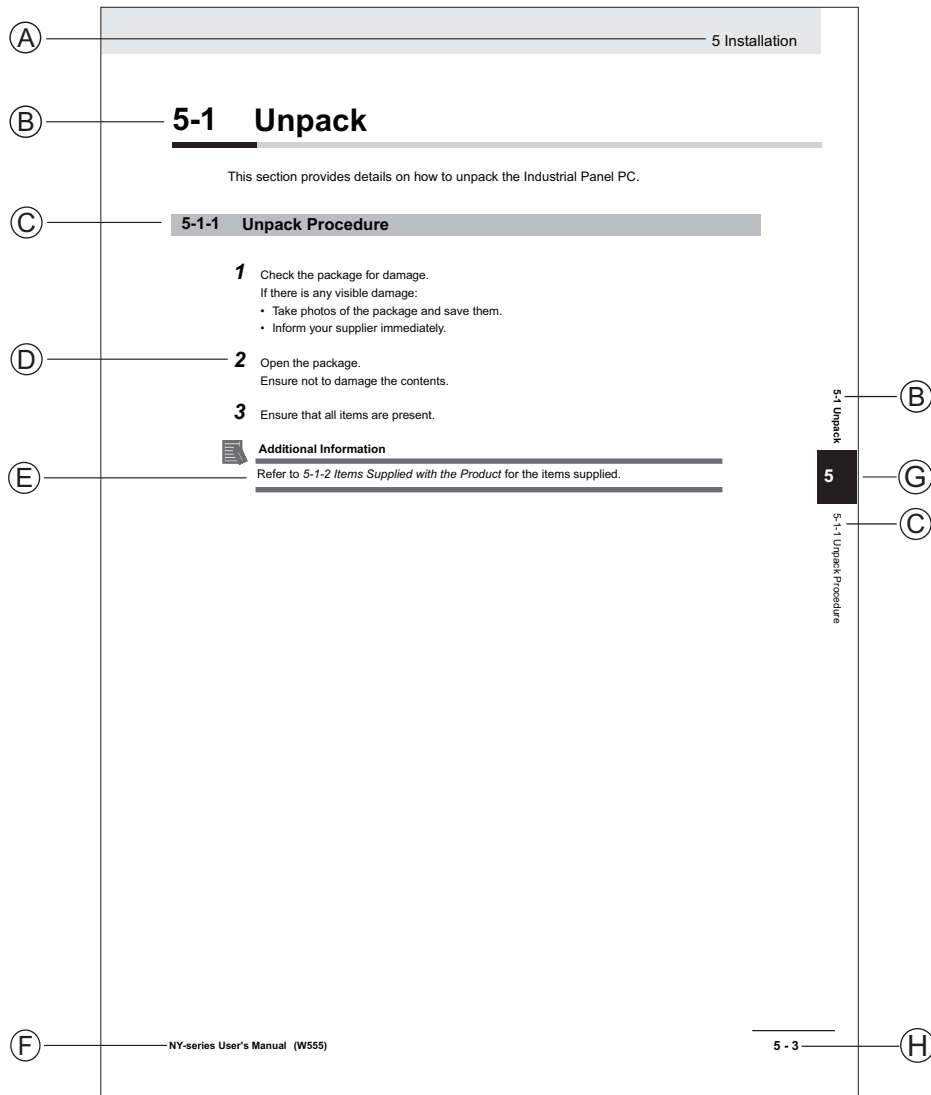

Note: This illustration is provided as a sample. It will not literally appear in this manual.

Item	Explanation	Item	Explanation
A	Level 1 heading	E	Special Information
B	Level 2 heading	F	Manual name
C	Level 3 heading	G	Page tab with the number of the main section
D	Step in a procedure	H	Page number

Special Information

Special information in this manual is classified as follows:

**Precautions for Safe Use**

Precautions on what to do and what not to do to ensure safe usage of the product.

**Precautions for Correct Use**

Precautions on what to do and what not to do to ensure proper operation and performance.

**Additional Information**

Additional information to read as required.

This information is provided to increase understanding or make operation easier.

CONTENTS

Introduction	1
Intended Audience	1
Manual Information	2
Page Structure	2
Special Information	2
Terms and Conditions Agreement.....	7
Warranty and Limitations of Liability	7
Application Considerations	7
Disclaimers	8
Safety Precautions.....	9
Definition of Precautionary Information.....	9
Symbols	9
Warnings.....	9
Related Manuals.....	11
Glossary.....	12
Revision History.....	13

Section 1 Configuring Basler Cameras

1-1 Basler Camera Configuration Overview	1-2
1-2 Basler Camera Connections	1-3
1-2-1 Power and Communications Connections	1-4
1-2-2 Position Latch Wiring	1-4
1-3 Basler Camera Software Configuration	1-7
1-3-1 Configure Network and Camera Settings.....	1-7

Section 2 Configuring Sentech Cameras

2-1 Sentech Camera Configuration Overview	2-2
2-2 Sentech Camera Connections	2-3
2-2-1 Power and Communications Connections	2-4
2-2-2 Position Latch Wiring	2-4
2-3 Sentech Camera Software Configuration	2-7
2-3-1 Configuring Network and Camera Settings.....	2-7

Section 3 Configuring Photoneo 3D Cameras

3-1 Photoneo 3D Camera Configuration Overview	3-2
3-2 Photoneo 3D Camera Connections.....	3-3
3-2-1 Photoneo 3D Camera Indicators	3-5
3-3 Photoneo 3D Software Configuration	3-6
3-3-1 Configure Camera Settings.....	3-6

Section 4 Configuring FH/FHV 2D Cameras

4-1	FH/FHV Camera Configuration Overview	4-2
4-2	Data Exchange Diagram	4-3
4-3	FH/FHV Camera Connections	4-4
4-3-1	FH/FHV Camera Connection Procedure	4-4
4-4	FH/FHV Software Configuration	4-5
4-4-1	FH/FHV Camera Location Array and Variables	4-5

Section 5 Configuring FH-SMD 3D Cameras

5-1	FH-SMD Camera Configuration Overview	5-2
5-2	FH-SMD Camera Connections	5-3
5-3	FH-SMD Software Configuration	5-4
5-3-1	Configure Network Settings	5-4

Section 6 Camera Latch Signal Test

6-1	Latch Signal Test Procedure	6-2
-----	-----------------------------------	-----

Terms and Conditions Agreement

Warranty and Limitations of Liability

Warranty

- **Exclusive Warranty**

Omron's exclusive warranty is that the Products will be free from defects in materials and workmanship for a period of twelve months from the date of sale by Omron (or such other period expressed in writing by Omron). Omron disclaims all other warranties, expressed or implied.

- **Limitations**

OMRON MAKES NO WARRANTY OR REPRESENTATION, EXPRESS OR IMPLIED, ABOUT NON-INFRINGEMENT, MERCHANTABILITY OR FITNESS FOR A PARTICULAR PURPOSE OF THE PRODUCTS. BUYER ACKNOWLEDGES THAT IT ALONE HAS DETERMINED THAT THE PRODUCTS WILL SUITABLY MEET THE REQUIREMENTS OF THEIR INTENDED USE.

Omron further disclaims all warranties and responsibility of any type for claims or expenses based on infringement by the Products or otherwise of any intellectual property right.

- **Buyer Remedy**

Omron's sole obligation hereunder shall be, at Omron's election, to (i) replace (in the form originally shipped with Buyer responsible for labor charges for removal or replacement thereof) the non-complying Product, (ii) repair the non-complying Product, or (iii) repay or credit Buyer an amount equal to the purchase price of the non-complying Product; provided that in no event shall Omron be responsible for warranty, repair, indemnity or any other claims or expenses regarding the Products unless Omron's analysis confirms that the Products were properly handled, stored, installed and maintained and not subject to contamination, abuse, misuse or inappropriate modification. Return of any Products by Buyer must be approved in writing by Omron before shipment. Omron Companies shall not be liable for the suitability or unsuitability or the results from the use of Products in combination with any electrical or electronic components, circuits, system assemblies or any other materials or substances or environments. Any advice, recommendations or information given orally or in writing, are not to be construed as an amendment or addition to the above warranty.

See <http://www.omron.com/global/> or contact your Omron representative for published information.

Limitations of Liability

OMRON COMPANIES SHALL NOT BE LIABLE FOR SPECIAL, INDIRECT, INCIDENTAL, OR CONSEQUENTIAL DAMAGES, LOSS OF PROFITS OR PRODUCTION OR COMMERCIAL LOSS IN ANY WAY CONNECTED WITH THE PRODUCTS, WHETHER SUCH CLAIM IS BASED IN CONTRACT, WARRANTY, NEGLIGENCE OR STRICT LIABILITY. Further, in no event shall liability of Omron Companies exceed the individual price of the Product on which liability is asserted.

Application Considerations

Suitability for Use

Omron Companies shall not be responsible for conformity with any standards, codes or regulations which apply to the combination of the Product in the Buyer's application or use of the Product. At Buyer's request, Omron will provide applicable third party certification documents identifying ratings and limitations of use which apply to the Product. This information by itself is not sufficient for a complete determination of the suitability of the Product in combination with the end product, machine, system, or other application or use. Buyer shall be solely responsible for determining appropriateness of the particular Product with respect to Buyer's application, product or system. Buyer shall take application responsibility in all cases.

NEVER USE THE PRODUCT FOR AN APPLICATION INVOLVING SERIOUS RISK TO LIFE OR PROPERTY WITHOUT ENSURING THAT THE SYSTEM AS A WHOLE HAS BEEN DESIGNED TO ADDRESS THE RISKS, AND THAT THE OMRON PRODUCT(S) IS PROPERLY RATED AND INSTALLED FOR THE INTENDED USE WITHIN THE OVERALL EQUIPMENT OR SYSTEM.

Programmable Products

- Omron Companies shall not be responsible for the user's programming of a programmable Product, or any consequence thereof.
- Omron Companies shall not be responsible for the operation of the user accessible operating system (e.g. Windows, Linux), or any consequence thereof.

Disclaimers

Performance Data

Data presented in Omron Company websites, catalogs and other materials is provided as a guide for the user in determining suitability and does not constitute a warranty. It may represent the result of Omron's test conditions, and the user must correlate it to actual application requirements. Actual performance is subject to the Omron's Warranty and Limitations of Liability.

Change in Specifications

Product specifications and accessories may be changed at any time based on improvements and other reasons. It is our practice to change part numbers when published ratings or features are changed, or when significant construction changes are made. However, some specifications of the Product may be changed without any notice. When in doubt, special part numbers may be assigned to fix or establish key specifications for your application. Please consult with your Omron's representative at any time to confirm actual specifications of purchased Product.

Errors and Omissions

Information presented by Omron Companies has been checked and is believed to be accurate; however, no responsibility is assumed for clerical, typographical or proofreading errors or omissions.

Safety Precautions

Definition of Precautionary Information

The following notation is used in this manual to provide precautions required to ensure safe usage of the i4H robot. The safety precautions that are provided are extremely important to safety.

Always read and heed the information provided in all safety precautions.

The following notation is used.



WARNING

Indicates a potentially hazardous situation which, if not avoided, could result in death or serious injury. Additionally, there may be severe property damage.

Symbols



The triangle symbol indicates precautions (including warnings).
The specific operation is shown in the triangle and explained in text.
This example indicates a precaution for electric shock.



The filled circle symbol indicates operations that you must do.
The specific operation is shown in the circle and explained in text.
This example shows a general precaution for something that you must do.



The triangle symbol indicates precautions (including warnings).
The specific operation is shown in the triangle and explained in text.
This example indicates a precaution for high temperatures.

Warnings

WARNING

General

Improper installation or wiring misconfiguration of the Camera Power Supply could result in electrical shock hazard. You must ensure the safe and proper installation of the Camera Power Supply in accordance with the applicable rules and regulations, and by qualified personnel.



The PhoXi 3D small scanners are Class 3R laser devices. The PhoXi 3D medium and large scanners are Class 3R or Class 2 laser devices.

- Avoid eye exposure to laser light. Looking at the laser beam may cause injury to the retina. When accidental eye exposure is possible, laser protective eyewear is recommended.
- It is recommended to locate PhoXi scanners in an environment that restricts laser light exposure to the surrounding area. Mirrors, polished surfaces, and similar objects should be removed from the vicinity of the laser scanner to avoid accidental exposure by reflection.



The surface of the PhoXi 3D processing unit becomes hot to touch when the device is in use. Mount the device on a metal mounting plate that will act as a thermal bridge to dissipate the heat and use the camera's carbon body to adjust the device.



Cybersecurity

To maintain the security and reliability of the system, a robust cybersecurity defense program should be implemented, which may include some or all of the following:

Anti-virus protection

- Install the latest commercial-quality anti-virus software on the computer connected to the control system and keep the software and virus definitions up-to-date.
- Scan USB drives or other external storage devices before connecting them to control systems and equipment.

Security measures to prevent unauthorized network access

- Install physical controls so that only authorized personnel can access control systems and equipment.
- Reduce connections to control systems and equipment via networks to prevent access from untrusted devices.
- Install firewalls to block unused communications ports and limit communication between systems. Limit access between control systems and systems from the IT network.
- Control remote access and adopt multifactor authentication to devices with remote access to control systems and equipment.
- Set strong password policies and monitor for compliance frequently.

Data input and output protection

- Backup data and keep the data up-to-date periodically to prepare for data loss.
- Validate backups and retention policies to cope with unintentional modification of input/output data to control systems and equipment.
- Validate the scope of data protection regularly to accommodate changes.
- Check validity of backups by scheduling test restores to ensure successful recovery from incidents.
- Safety design, such as emergency shutdown and fail-soft operations in case of data tampering and incidents.

Additional recommendations

- When using an external network environment to connect to an unauthorized terminal such as a SCADA, HMI or to an unauthorized server may result in network security issues such as spoofing and tampering.
- You must take sufficient measures such as restricting access to the terminal, using a terminal equipped with a secure function, and locking the installation area by yourself.
- When constructing network infrastructure, communication failure may occur due to cable disconnection or the influence of unauthorized network equipment.
- Take adequate measures, such as restricting physical access to network devices, by means such as locking the installation area.
- When using devices equipped with an SD Memory Card, there is a security risk that a third party may acquire, alter, or replace the files and data in the removable media by removing or unmounting the media.
- Please take sufficient measures, such as restricting physical access to the Controller or taking appropriate management measures for removable media, by means of locking and controlling access to the installation area.
- Educate employees to help them identify phishing scams received via email on systems that will connect to the control network.



Related Manuals

Use the following related manuals for reference.

Manual Title	Description
Robot Safety Guide (Cat. No. I590)	Provides safety information for OMRON industrial robots.
Robot Vision Manager User's Manual (Cat. No. I667)	Provides information necessary for understanding the correct use of vision cameras.
V+ Module Reference Manual (Cat. No. I668)	Provides information necessary for understanding and use of V+ Modules.
V+ Keyword Reference Manual (Cat. No. I672)	Provides references to V+ Keyword use and functionality.
FH/FHV Series Vision System Operation Manual for Sysmac Studio (Cat. No. Z343)	Provides information for the integration and operation of the FH camera with Sysmac Studio.
FH/FHV Series Vision System User's Manual (Cat. No. Z366)	Provides information for proper operation of the FH camera within a network.
FH Series Vision System Hardware Setup Manual (Cat. No. Z366)	Contains information to install and properly wire the FH cameras.
FH Series Vision System Hardware Setup Manual for 3D Robot Vision (Cat. No. Z436)	Contains information to install and properly wire the FH-SMD 3D cameras.
FH Series Vision System Processing Item Function Reference Manual for 3D Robot Vision (Cat. No. Z445)	Describes the software functions, settings, and operations for using FH series 3D robot vision system.
XIO Termination Block 12-8 Installation Guide (00340-000)	Provides information to properly wire the XIO Termination Block.
Automation Control Environment (ACE) Version 4 User's Manual (Cat. No. I633)	Provides information for operation of cameras within the ACE software.
Industrial PC Platform NY-series Industrial Box PC Hardware User's Manual (Cat. No. W553)	Provides information on connecting cameras to the IPC.

Glossary

Term / Abbreviation	Description
GigE	Gigabyte Ethernet
GPIO	General Purpose Input/Output
NIC	Network Interface Card
PoE	Power Over Ethernet

Revision History

A manual revision code appears as a suffix to the catalog number on the front and back covers of the manual.

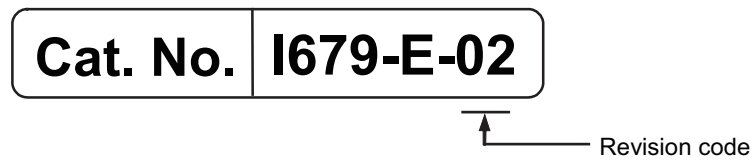

Revision code	Date	Revised content
02	November 2024	Corrections and revisions
01	August 2022	Original production

1

Configuring Basler Cameras

This section provides information about configuring Basler cameras to work with the ACE software.

1-1	Basler Camera Configuration Overview	1-2
1-2	Basler Camera Connections	1-3
1-2-1	Power and Communications Connections	1-4
1-2-2	Position Latch Wiring.....	1-4
1-3	Basler Camera Software Configuration	1-7
1-3-1	Configure Network and Camera Settings.....	1-7

1-1 Basler Camera Configuration Overview

ACE Robot Vision Manager tools support Basler cameras supplied by OMRON. These cameras need configuration prior to use with the ACE software.

Complete the following steps to configure Basler cameras.

- 1** Complete the camera's power and communication connections.
- 2** Configure the camera's software.
- 3** After connecting and configuring the camera, the camera can be added to the ACE project.



Additional Information

Refer to the *Automation Control Environment (ACE) Version 4 User's Manual (Cat. No. I633)* for more information on adding a camera to an ACE project.

1-2 Basler Camera Connections

WARNING

Improper installation or wiring misconfiguration of the Camera Power Supply could result in electrical shock hazard. You must ensure the safe and proper installation of the Camera Power Supply in accordance with the applicable rules and regulations, and by qualified personnel.

Use the following information to understand the Basler camera connections.

Basler cameras include power and data cables, with the following OMRON part numbers.

- Power I/O cable part number: 09454-610
- Cat6 Camera Cable part number: 18472-000

USB 3.0 Micro B cables for cameras with a USB Communications Port are user-supplied.

The following figure and table lists the communication and power connections for Basler cameras.

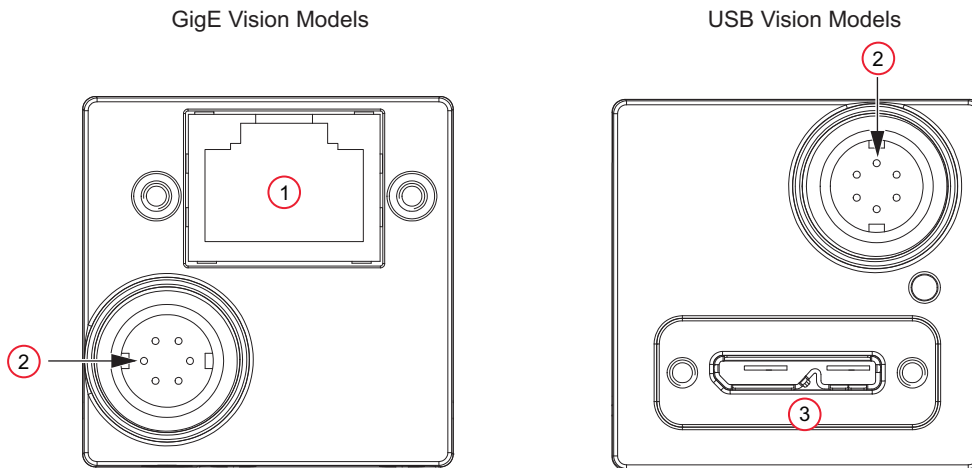

Item	Description
1	Camera Communications Port (RJ45)
2	Power I/O Connection
3	Camera Communications Port (USB 3.0 Micro B)

The following figure and table list the example I/O connections for a Basler acA1600-60gm camera. Refer to Basler camera documentation for wiring information related to other specific cameras.

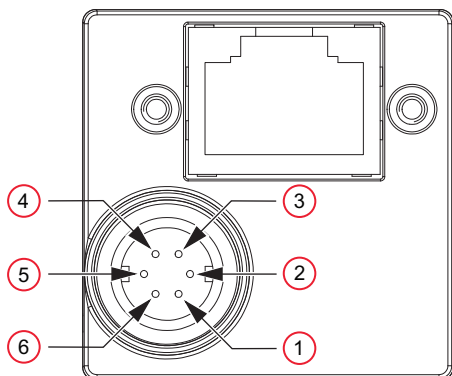

**Additional Information**

Wire colors indicated in the tables below correspond to the power I/O cable supplied with the camera (OMRON part number 09454-610).

Item	Wire Color	Description
1	Brown	Camera Power (+12 VDC)
2	Pink	Opto IN 1
3	Green	No Connection
4	Yellow	Opto OUT 1
5	Gray	Opto I/O Ground
6	White	Camera Power (0 VDC)

1-2-1 Power and Communications Connections

Both GPIO and non-GPIO cameras supported by the ACE software. As described below, the camera connections will vary depending on the camera type.

Camera Power Connections

Use the following information to supply power to the camera.

Power can be supplied to Basler Power Over Ethernet (POE) cameras in two manners: with the POE Ethernet cable (the default) or with the Power I/O cable (external power). Refer to *1-2 Basler Camera Connections* on page 1-3 for more information.

**Additional Information**

When using a GigE type camera, external power connections should not be used if the camera is connected to a POE port.

If POE is not in use, refer to the Basler documentation for a specific camera for information on supplying external power via the Power I/O cable.

Camera Communication Connections

If using a GigE type camera, connect the RJ45 camera port to the IPC or the local area network using the supplied Cat6 camera cable.

If using a USB camera, connect the USB port to the IPC using the user-supplied USB cable.

1-2-2 Position Latch Wiring

If a camera is used in a vision-guided application with functions such as belt tracking or position refinement, a position latch signal must be connected from the camera to a robot controller input signal. This will allow the robot controller to capture the belt or robot position when the latch condition is met.

Use the information in this section to wire and configure a typical latch position signal from a connected Basler camera.

SmartController XDIO Terminal Block Connection Example

The following example applies when using the SmartController XDIO terminal block to receive a rising edge latch on input 1001 (+1001 in the latch configuration).

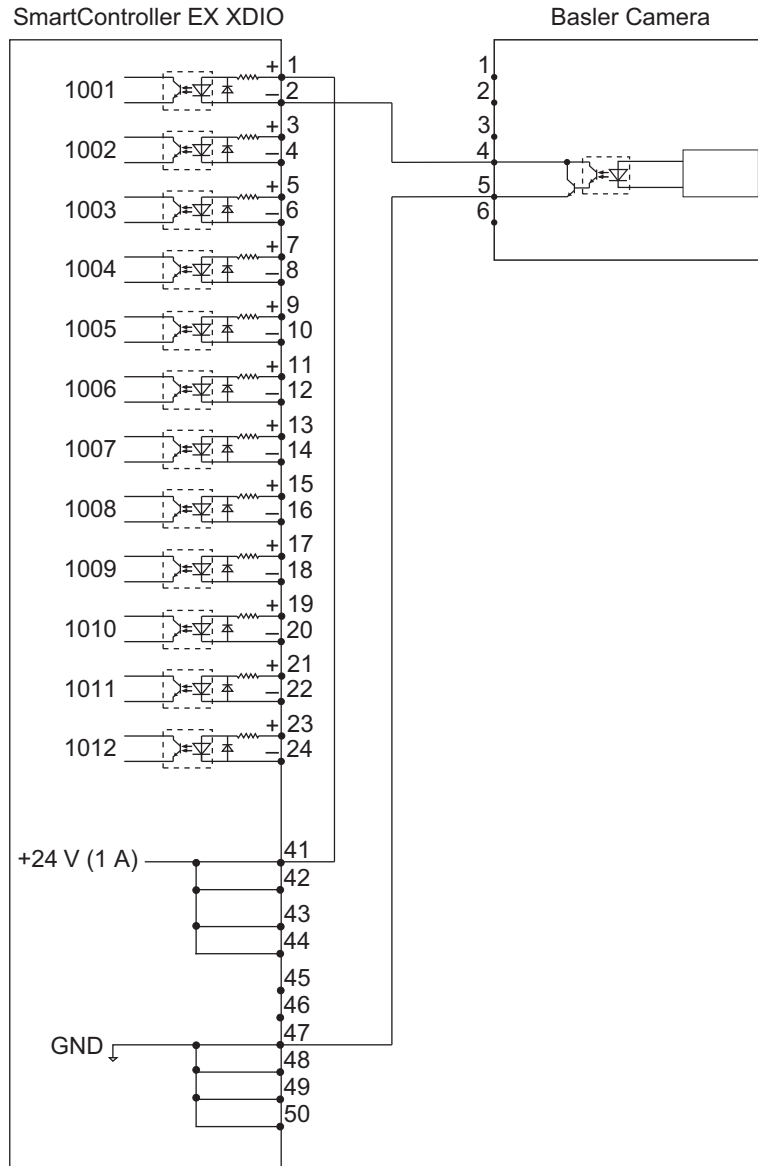

XIO Terminal Block Connection Example

The following example applies when using the robot controller XIO terminal block to receive a rising edge latch on input 1001.



Additional Information

- Signal numbers may differ from what is shown in the following figure. Refer to the robot User's Manual for more information.
- Ensure the appropriate XIO Termination Block bank switch is in the LO position. Refer to the *XIO Termination Block 12-8 Installation Guide (00340-000)* for more information.

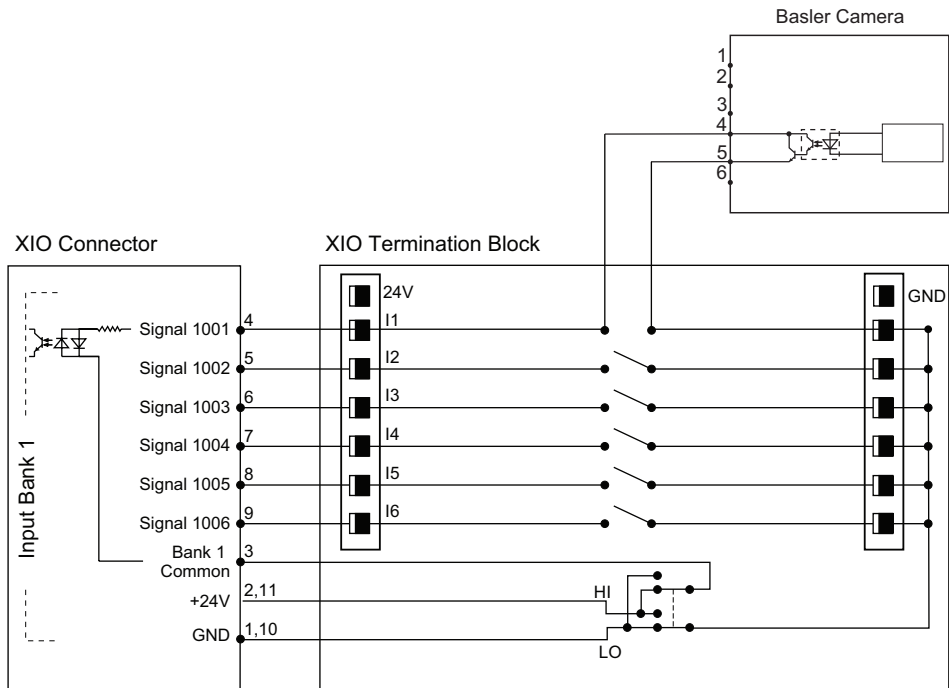

1-3 Basler Camera Software Configuration

The ACE software installation includes the Basler Pylon Suite that is required for camera configuration. Use the information below to make camera settings before adding the camera to the ACE project.



Precautions for Correct Use

The ACE software and Pylon tools cannot access a camera simultaneously. If an active connection is present between the camera and the ACE software, camera settings will be inaccessible from Pylon tools. Always disconnect the Pylon Viewer tool before opening an ACE project with a Basler camera object present.

1-3-1 Configure Network and Camera Settings

After the camera cable connections are complete, configure the network and camera settings described below.



Additional Information

The Pylon tools referenced in this section can be found in the Windows Start Menu under the Basler program group. These tools are included with the default ACE software installation.

IPC Port Settings

Open the IPC Control Panel and then open the Network Connections. Right click the port used for the Basler camera and select **Properties**. Select *Internet Protocol Viewer 4 (TCP/IPv4)* and click **Properties** to open that panel, as shown in the following figure.

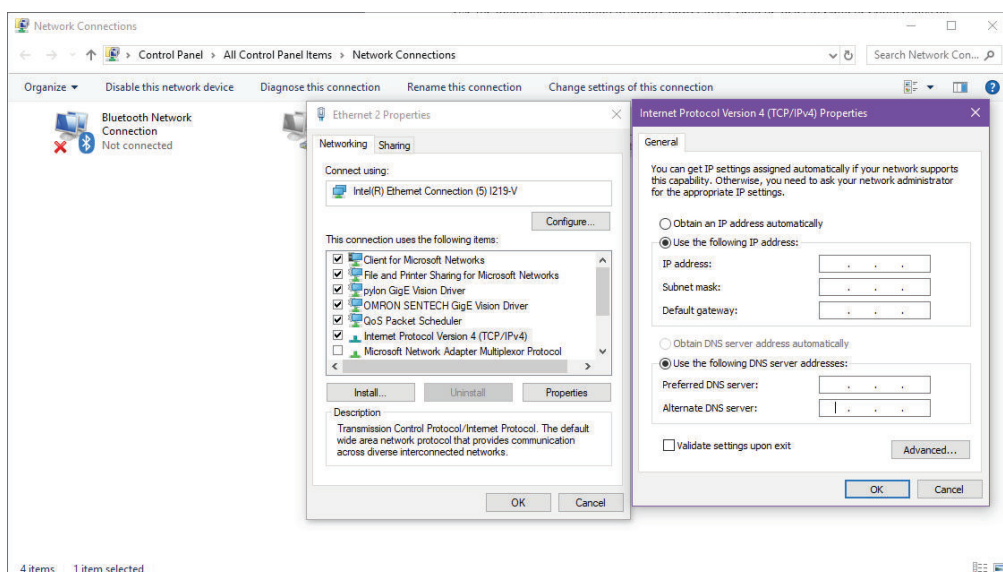

Use the Network Properties to configure an appropriate static IP address for the IPC port communicating with the Basler Camera. It is recommended to connect one GigE camera per port or network interface card address. When done, click **OK** on the Properties panel.

Jumbo Packet Settings

From the IPC Network configuration window, right click on the desired network, select **Properties**, select **Configure**, and then select the **Advanced** Tab.

Scroll down the *Property* Options and select **Jumbo Packet**. In the *Value* section, use the drop-down and select **9014 Bytes**, matching the settings in the GigE camera, as shown in the following figure.

Then click the **OK** Button to complete the setting.

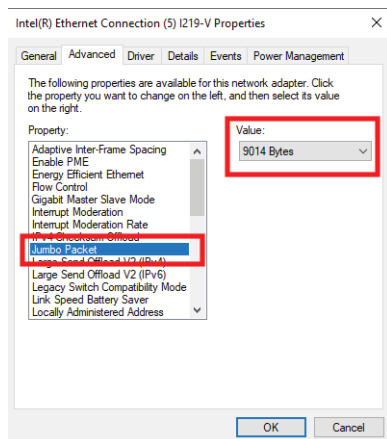

Additional Information

If *Jumbo Frames* is listed in the Property Options instead of *Jumbo Packet*, set the value to *GigE Vision Only*.

Adjust Camera Network Settings



Precautions for Correct Use

Ensure that the camera is not connected to the ACE software before following the procedure below.

From the Windows Start Menu, navigate to the Basler Directory and open the Pylon IP Configurator application to view the camera communication status with the IPC. If the camera IP configuration is incorrect, this tool can be used to correct the settings. Click the **Save** Button after making any setting adjustments.

The figure below provides examples of one camera that is communicating properly and one camera that is not reachable due to an incompatible subnet configuration.

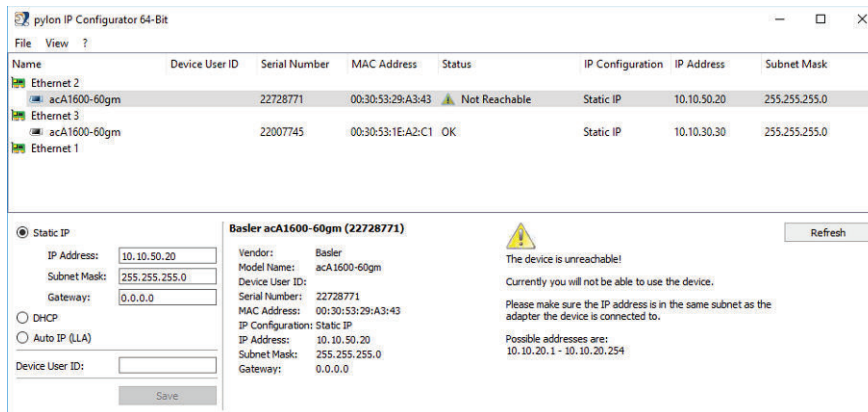

For adding a note:



Additional Information

If a camera is unreachable, right click on the Camera in the Pylon Configurator and select **Assign Temporary IP Address**. Then set the IP address to match the parameters of your IPC's static IP address.

Two cameras can operate on either individual IP addresses or the same IP address. The following figure shows two cameras operating in continuous mode on the same IP address. Each camera is connected to the IPC through a specific Network Interface Card (NIC), using a Basler GigE Vision Adapter.

The maximum data rate for the IPC is 125 Mbytes/s. To check data rate and communication quality, use the Pylon Viewer application and adjust the fps as needed.

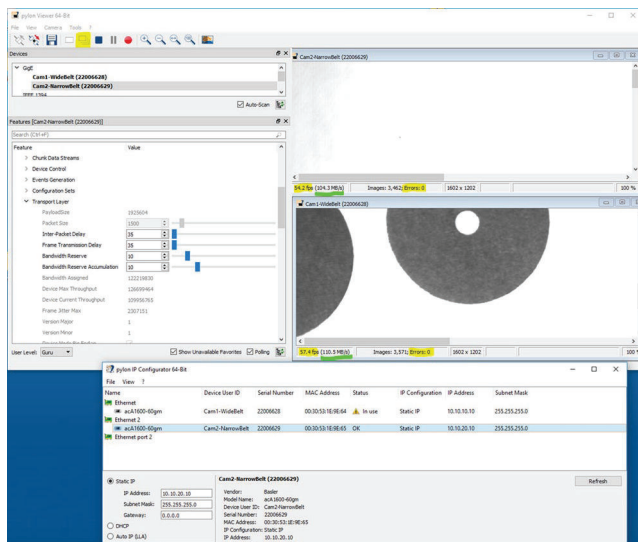

Issues can arise because different NICs and switches support various packet sizes. Defining the correct packet size is system dependent. When the packets are too small, the NIC buffers may become overloaded and packets may be dropped. When packets are too large, the NIC may not support that size and may also drop the packets. Whenever a packet is dropped, the ACE driver detects the drop and requests the camera to resend.

The typical packet size of approximately 500 bytes is too small for large images containing significant amounts of data. However, few devices support full 16000 Byte packets. If the CPU load is excessive, use a small packet size setting of 1500 bytes and confirm performance. Increase as necessary after making the confirmation.

Enabling the **Auto Packet Size** feature in the camera is another option that prompts the camera to negotiate a working packet size automatically.

Adjust Camera Image Acquisition Settings

The Pylon Viewer is used to adjust the camera image acquisition settings. Use this tool to enable the Exposure Active signal and change any other necessary camera settings.



Precautions for Correct Use

If any camera settings are changed with the Pylon Viewer tool after it has been added to the ACE project, camera functions may be disrupted.

Open the Pylon Viewer tool and select a camera from the *Devices List*. Then, click the **Open Camera** Button to access all settings associated with the selected camera.

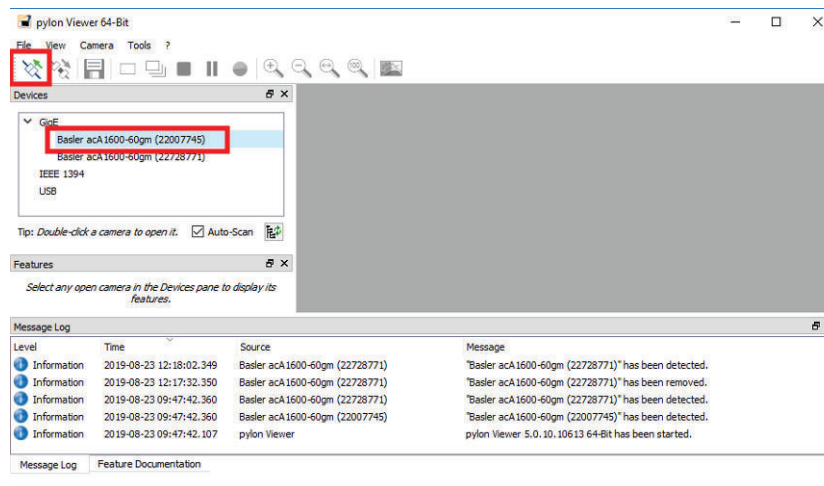

● Enable the Exposure Active Signal

The Exposure Active signal is an output from the camera to the robot controller that indicates the moment when the camera acquired an image. This signal is used by the robot controller for position latching in applications that use vision-guided motion. The Exposure Active signal must be enabled for all applications that require robot or belt encoder position latching.

Expand the **Digital I/O Controls** Item and make the following settings.

- Set the Line Selector item to **Output Line 1**.
- Set the Line Source item to **Exposure Active**.

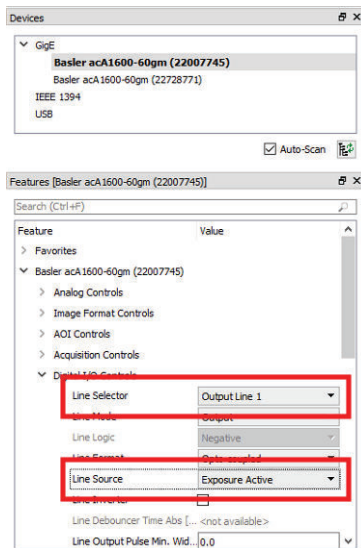

● Save Camera Settings

All changes to Basler camera settings need to be saved to the profile using the *User Set Save* command. *User Set Save* ensures the settings are applied when the camera loses power or the connected IPC is restarted. The profile selected using *User Set Save* will be loaded on reboot. Before loading or saving User Profiles, acquisition needs to be turned OFF by pressing the **STOP** Button in the top left corner in the tool bar.

The controls for saving and loading User Profiles are found in the *Features* Menu by clicking on the desired camera and selecting the **Configuration Sets** Dropdown. Alternatively, the Features search bar can be used to quickly located *User Set Save*, *User Set Load*, or other controls. To save any settings, for example, to User Set 1, change *Configuration Set Selector* to *User Set 1*, as shown in the figure below. Next, execute **User Set Save**. When *Default Startup Set* is set to *User Set 1*, the camera will load User Set 1 settings when power is applied.

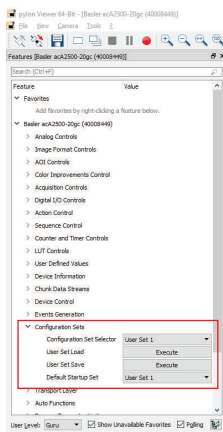

● Image Acquisition Check

Use the Pylon Viewer tool to confirm image acquisition before adding the camera object to the ACE project. Use the **Single Shot** Button to acquire an image and then make any necessary adjustments such as exposure or white balance.

After you have completed configuring the Basler camera using Pylon Viewer, close the Pylon Viewer application to avoid connection errors. If you test the camera in the ACE software and receive the exception shown below, it indicates that Pylon Viewer is still operating. Close Pylon Viewer to clear this exception.

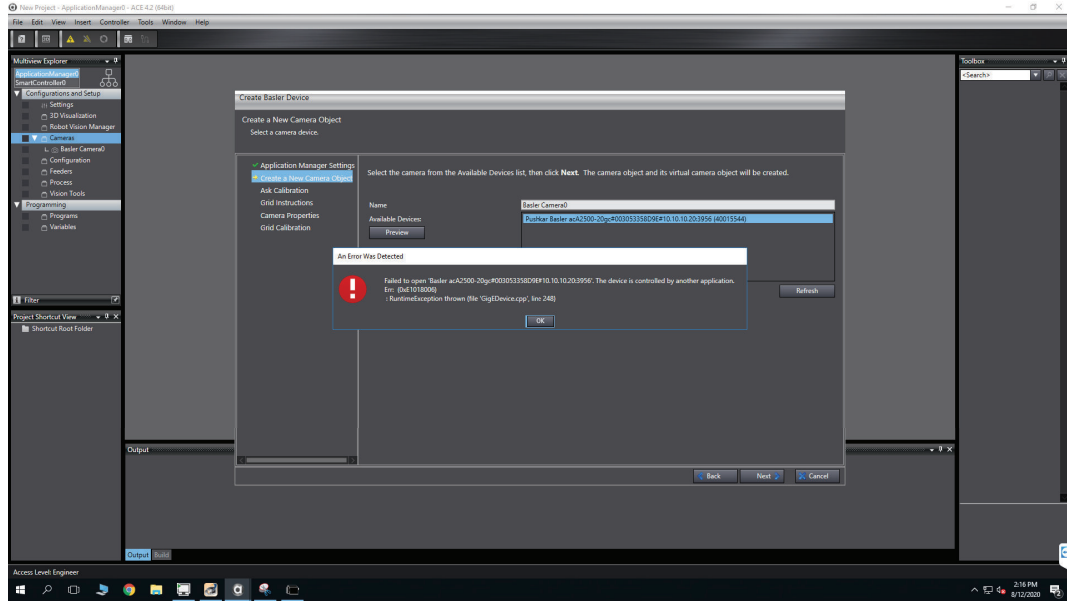

2

Configuring Sentech Cameras

This section provides information about configuring Sentech cameras to work with the ACE software.

2-1	Sentech Camera Configuration Overview	2-2
2-2	Sentech Camera Connections	2-3
2-2-1	Power and Communications Connections	2-4
2-2-2	Position Latch Wiring.....	2-4
2-3	Sentech Camera Software Configuration	2-7
2-3-1	Configuring Network and Camera Settings	2-7

2-1 Sentech Camera Configuration Overview

ACE Robot Vision Manager tools support Sentech cameras supplied by OMRON. These cameras need configuration prior to use with the ACE software.

Complete the following steps to configure Sentech cameras.

- 1** Complete the camera's power and communication connections.
- 2** Configure the camera's software.
- 3** After connecting and configuring the camera, the camera can be added to the ACE project.



Additional Information

Refer to the *Automation Control Environment (ACE) Version 4 User's Manual (Cat. No. I633)* for more information on adding a camera to an ACE project.

2-2 Sentech Camera Connections

WARNING

Improper installation or wiring misconfiguration of the Camera Power Supply could result in electrical shock hazard. You must ensure the safe and proper installation of the Camera Power Supply in accordance with the applicable rules and regulations, and by qualified personnel.

Use the following information to understand the Sentech camera connections.

Sentech cameras include power and data cables with the following OMRON part numbers.

- Power I/O Cable part number: 21942-000
- Cat5e Camera Cable part number: 21943-000

USB 3.0 Micro B cables for cameras with a USB Communications Port are user-supplied.

The following figure and table lists the communication and power connections for Sentech cameras.

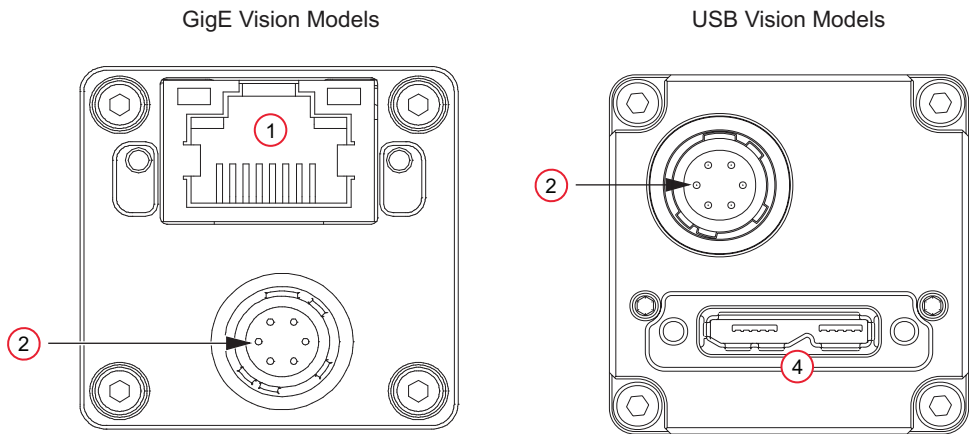

Item	Description
1	Camera Communications Port (RJ45)
2	Power I/O Connection
3	Camera Communications Port (USB 3.0 Micro B)

The following figure and table list the example I/O connections for a Sentech STC-MBS202POE camera. Refer to Sentech camera documentation for wiring information related to other specific cameras.

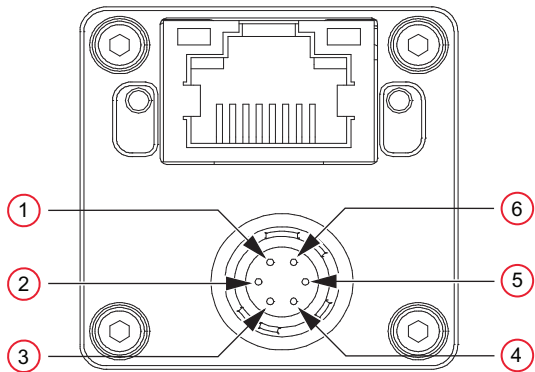

Additional Information

Wire colors indicated in the table above correspond to the power I/O cable supplied with the camera kit (OMRON part number 21942-000).

Item	Wire Color	Description
1	Blue	Power IN
2	White	Opto isolated IN (Line 0)
3	Yellow	Open Collector GPIO (Line 2)
4	Brown	Opto isolated OUT (Line 1) Open Collector
5	Green	Opto isolated Common
6	Black	GND

2-2-1 Power and Communications Connections

The following section describes how to establish communication between the Camera and the IPC.

Camera Power Connections

Use the following information to supply power to the camera.

Power can be supplied to Sentech Power Over Ethernet (POE) cameras in two manners: with the POE Ethernet cable (the default) or with the Power I/O cable (external power). Refer to *2-2 Sentech Camera Connections* on page 2-3 for more information.



Additional Information

When using a GigE type camera, external power connections should not be used if the camera is connected to a POE port.

If POE is not in use, refer to the Sentech documentation for a specific camera for information on supplying external power via the Power I/O cable.

Camera Communication Connections

If using a GigE type camera, connect the RJ45 camera port to the IPC or the local area network using the supplied Cat6 camera cable.

If using a USB camera, connect the USB port to the IPC using the user-supplied USB cable.

2-2-2 Position Latch Wiring

If a camera is used in a vision-guided application with functions such as belt tracking or position refinement, a position latch signal must be connected from the camera to a robot controller input signal. This will allow the robot controller to capture the belt or robot position when the latch condition is met.

Use the information in this section to wire and configure a typical latch position signal from a connected Sentech camera.

SmartController XDIO Terminal Block Connection Example

The following example applies when using the SmartController XDIO terminal block to receive a rising edge latch on input 1001 (+1001 in the latch configuration).

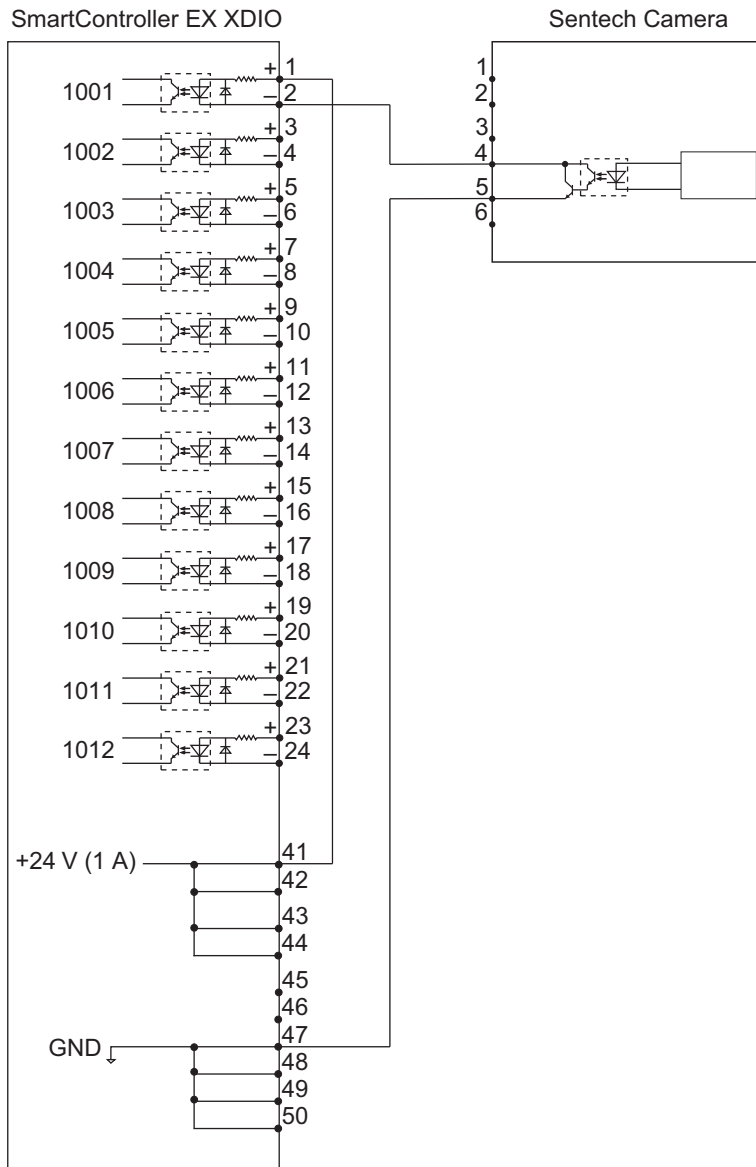

XIO Terminal Block Connection Example

The following example applies when using the robot controller XIO terminal block to receive a rising edge latch on input 1001.



Additional Information

- The figure shows a rising edge latch. Falling edge latches can also be set during configuration.
- Signal numbers may differ from what is shown in the following figure. Refer to the robot User Guide for more information.
- Ensure the appropriate XIO Termination Block bank switch is in the LO position. Refer to the *XIO Termination Block 12-8 Installation Guide (00340-000)* for more information.

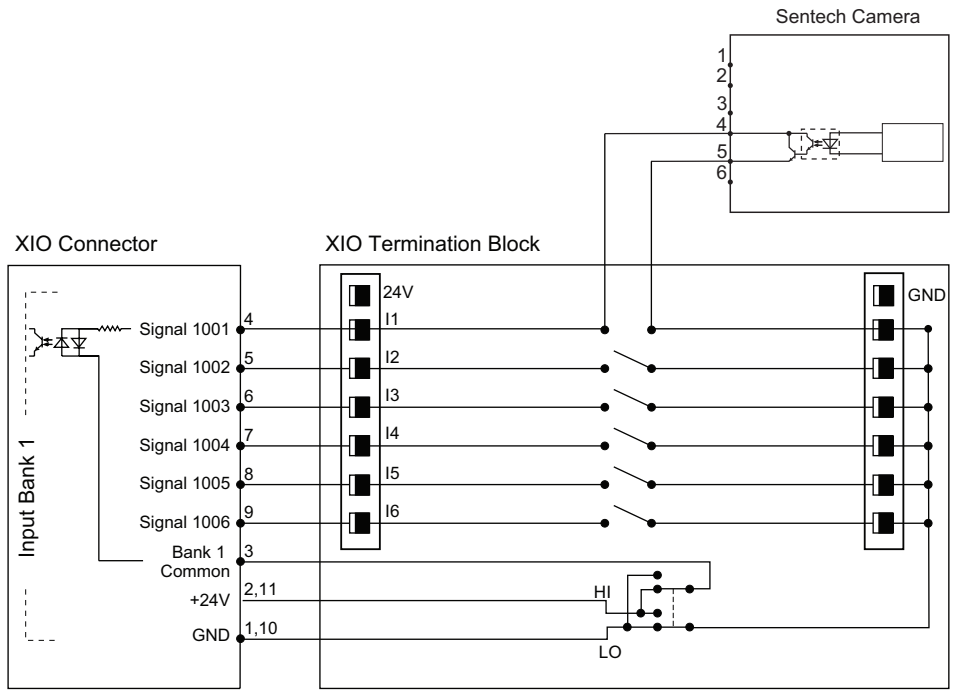

2-3 Sentech Camera Software Configuration

The ACE software installation includes the Sentech StViewer and GigE Camera IP Config utilities that are required for the camera configuration. Use the information below to make camera settings before adding the camera to the ACE project.



Precautions for Correct Use

The ACE software and StViewer tool cannot access a camera simultaneously. Always disconnect the StViewer tool before opening an ACE project with a Sentech camera object present.

2-3-1 Configuring Network and Camera Settings

After the camera cable connections are complete, configure the network and camera settings described below.



Additional Information

The StViewer tools referenced in this section can be found in the Windows Start Menu under the Sentech SDK program group. These tools are included with the default ACE software installation.

IPC Port Settings

Open the IPC Control Panel and then open the Network Connections. Right click the port used for the Sentech camera and select **Properties**. Select *Internet Protocol Viewer 4 (TCP/IPv4)* and click **Properties** to open that panel, as shown in the following figure.

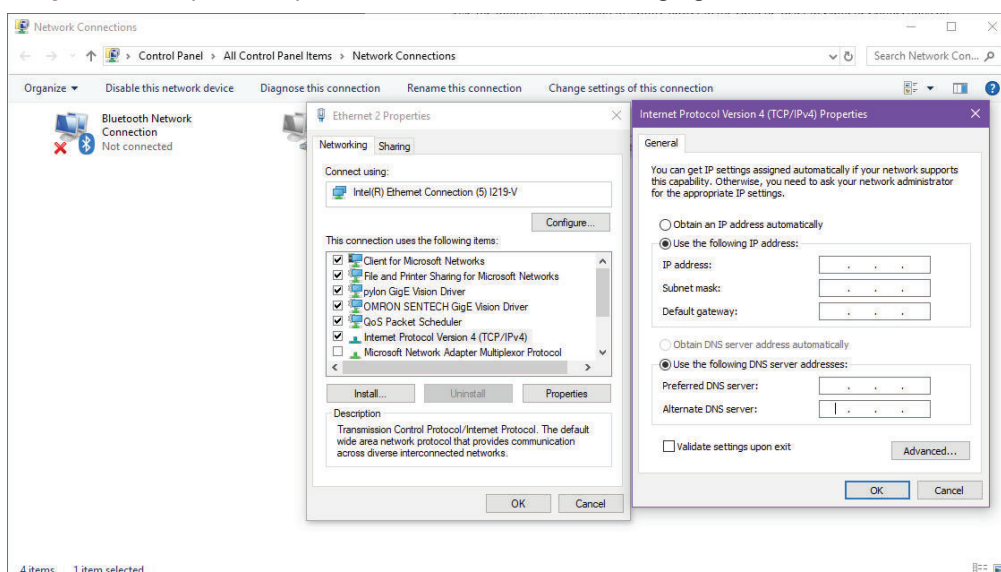

Use the Network Properties to configure an appropriate static IP address for the IPC port communicating with the Sentech Camera. It is recommended to connect one GigE camera per port or network interface card address. When done, click **OK** on the Properties panel.

Jumbo Packet Settings

From the IPC Network configuration window, right click on the desired network, select **Properties**, select **Configure**, and then select the **Advanced** Tab.

Scroll down the *Property* Options and select **Jumbo Packet**. In the *Value* section, use the drop-down and select **9014 Bytes**, matching the settings in the GigE camera, as shown in the following figure.

Then click the **OK** Button to complete the setting.

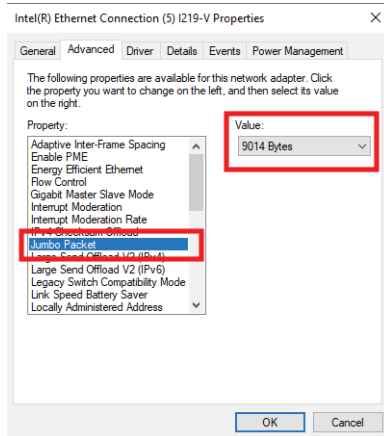

Additional Information

If *Jumbo Frames* is listed in the Property Options instead of *Jumbo Packet*, set the value to *GigE Vision Only*.

Adjust Camera Network Settings



Precautions for Correct Use

Ensure that the camera is not connected to the ACE software before following the procedure below.

From the Windows Start Menu, navigate to the Sentech SDK directory and open GigECameraIPConfig to view the camera communication status with the IPC. If the camera IP configuration is incorrect, this tool can be used to correct the settings. Click the **Apply** Button after making any setting adjustments.



Additional Information

Click the DHCP and persistent IP check-boxes, as shown in the following figure, to ensure the IP settings persists even after the camera is rebooted.

The figure below provides an example that shows the IP settings for one camera that is communicating properly.

GigE Camera IP Config

STC-MBS202POE(19LE904) Select camera

Network interface card information

IP address: 10 . 10 . 40 . 41
 Subnet mask: 255 . 255 . 255 . 0
 Default: . . .

Current IP setting

IP address: 10 . 10 . 40 . 40
 Subnet mask: 255 . 255 . 255 . 0
 Default: 0 . 0 . 0 . 0

Persistent IP / IP configuration

IP address: 10 . 10 . 40 . 40 Link local address
 Subnet mask: 255 . 255 . 255 . 0 DHCP
 Default: 0 . 0 . 0 . 0 Persistent IP

Copy current IP setting Apply

Adjust Camera Image Acquisition Settings

Use StViewer to enable the Exposure Active signal and change any other necessary camera settings before adding a camera to the ACE project.



Precautions for Correct Use

If any camera settings are changed with the GigECameraIPConfig or the StViewer tool after it has been added to the ACE project, camera functions may be disrupted.

Device Selection

Found Devices

- OMRON SENTECH GenTL
 - USB3Vision
 - Intel(R) I210 Gigabit Network Connection #4
 - Intel(R) I210 Gigabit Network Connection #5
 - Intel(R) I210 Gigabit Network Connection #6
 - Intel(R) I210 Gigabit Network Connection
 - STC-MBS202POE(19LE904)**
 - Intel(R) I210 Gigabit Network Connection #2
 - Intel(R) I210 Gigabit Network Connection #3
 - Intel(R) Ethernet Connection (2) I219-LM

System Information

Vendor	OMRON_SENTECH
Model	GenTL
Version	1.5.56.94
TL Type	Moved
Name	SiGenTL.cti
Path Name	C:\Program Files\Common Files\Sentech\GenTL\SiGenTL.cti
Display Name	OMRON SENTECH GenTL
GenTL Version Major	1
GenTL Version Minor	5

Interface Information

Display Name	Intel(R) I210 Gigabit Network Connection
TL Type	GEV
MAC Address	FB:02:78:20:60:8a
IP Address	10.10.40.41
Subnet Mask	255.255.255.0

Device Information

ID	D4:7C:44:30:27:20
Vendor	OMRON_SENTECH
Model	STC-MBS202POE
TL Type	GEV
Display Name	STC-MBS202POE(19LE904)
MAC Address	64:7c:44:30:27:20
IP Address	10.10.40.40
Subnet Mask	255.255.255.0
Gateway	0.0.0.0
Access Status	ReadWrite(Full access)[1]
User Defined Name	W-belt Sentech
Serial Number	19LE904
Version	7.24.2

Set IP Address ... Device Discovery ... OK Cancel

Ensure that ACE is closed before proceeding. Open StViewer and then select a camera from the *Found Devices* list. Then, click the **OK** Button to access all settings associated with the selected camera.

Enable the Exposure Active Signal

The Exposure Active signal is an output from the camera to the robot controller that indicates the moment when the camera acquired an image. This signal is used by the controller for position latching in applications that use vision-guided motion. The *Exposure Active* signal must be enabled for all applications that require robot or belt encoder position latching.

Expand the **Digital I/O Controls** item, and make the following settings.

- Set the Line Selector item to **Line 1**.
- Set Line Mode to *Output*.
- Set the Line Source item to **Exposure Active**.
- Set Line Inverter to *True*.

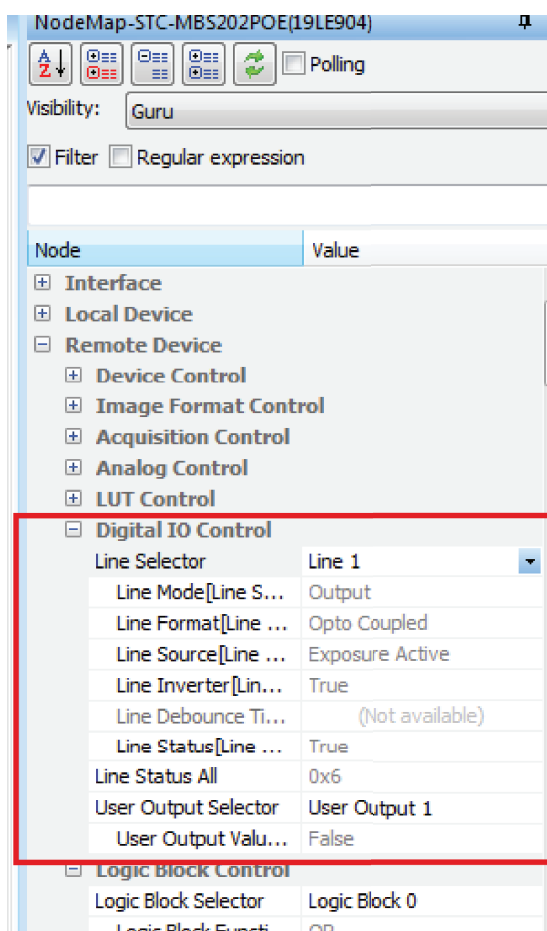

Save Camera Settings

All changes to Sentech camera settings need to be saved to the profile using the *User Set Save* command. *User Set Save* ensure the settings are applied when the camera loses power or the connected IPC is restarted. The profile selected using *User Set Save* will be loaded on reboot.

Before loading or saving User Profiles, acquisition needs to be turned OFF by pressing the **STOP Acquisition** Button in the top left corner in the tool bar.

To save these settings, for example, to User Set 0, change *User Set Selector* to *User Set 0*. Next, execute **User Set Save**. When *User Set Default* is set to *User Set 0*, the camera will load User Set 0 settings when power is applied.

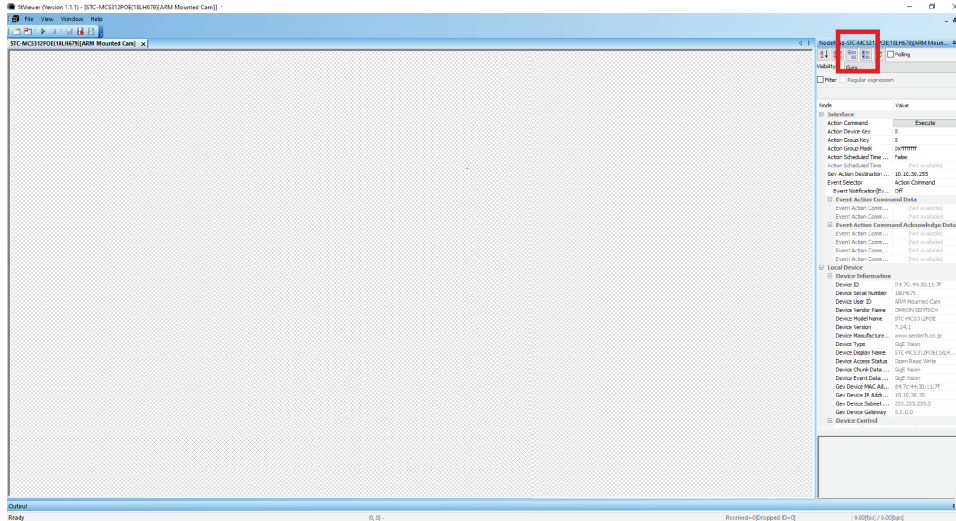

In the above figure, the icons within the red box are used to expand or collapse the details and options in the right-side column.

Image Acquisition Check

If needed, use the StViewer tool to confirm image acquisition before adding the camera object to the ACE project. After selecting the appropriate camera, enable image acquisition using the **PLAY** Button in the top left corner and use the **Trigger Software Execute** Button under *Remote Device_Acquisition Control* to acquire an image. Customize the camera exposure or white balance if required.

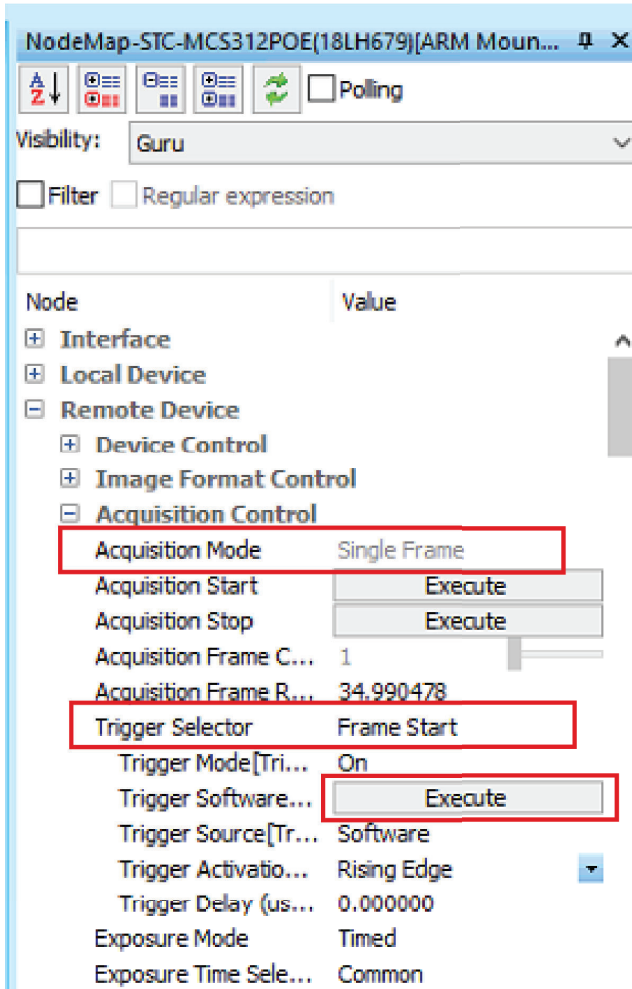

After you have completed the check process, close STViewer. If STViewer is not closed, ACE may not be able to communicate with the camera, and the following exception may occur. Close STViewer to clear this exception.

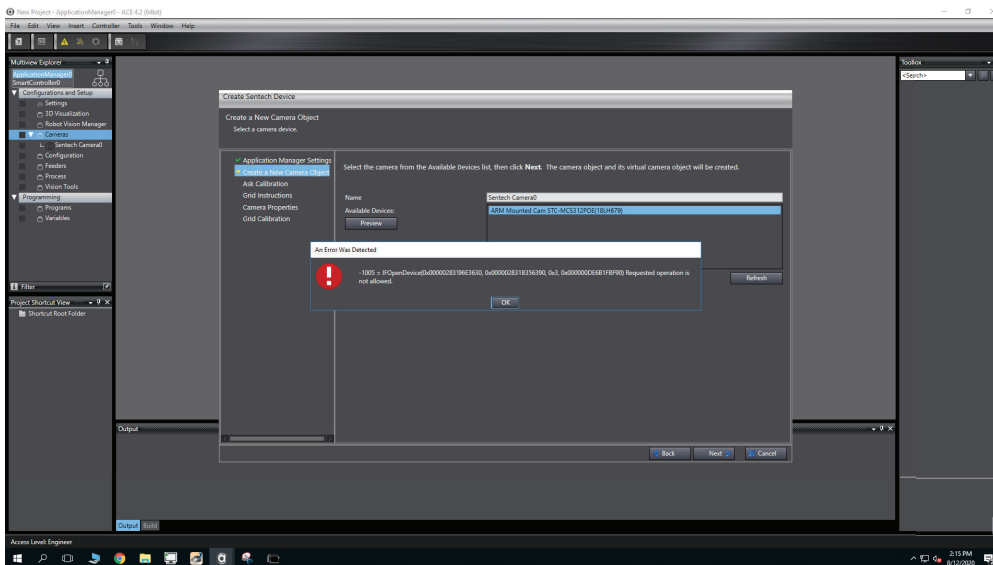

3

Configuring Photoneo 3D Cameras

This section provides information about configuring Photoneo 3D cameras to work with the ACE software.

3-1	Photoneo 3D Camera Configuration Overview	3-2
3-2	Photoneo 3D Camera Connections	3-3
3-2-1	Photoneo 3D Camera Indicators	3-5
3-3	Photoneo 3D Software Configuration	3-6
3-3-1	Configure Camera Settings	3-6

3-1 Photoneo 3D Camera Configuration Overview

ACE Robot Vision Manager tools support 3D cameras supplied by Photoneo. These cameras need configuration prior to use with the ACE software.

Complete the following steps to configure Photoneo 3D cameras.

- 1** Complete the camera's power and communication connections.
- 2** Configure the camera's software.
- 3** After connecting and configuring the camera, the camera can be added to the ACE project.



Additional Information

Refer to the *Automation Control Environment (ACE) Version 4 User's Manual (Cat. No. I633)* for more information on adding a camera to an ACE project.

3-2 Photoneo 3D Camera Connections

WARNING

Improper installation or wiring misconfiguration of the Camera Power Supply could result in electrical shock hazard. You must ensure the safe and proper installation of the Camera Power Supply in accordance with the applicable rules and regulations, and by qualified personnel.



WARNING

The PhoXi 3D small scanners are Class 3R laser devices. The PhoXi 3D medium and large scanners are Class 3R or Class 2 laser devices.

- Avoid eye exposure to laser light. Looking at the laser beam may cause injury to the retina. When accidental eye exposure is possible, laser protective eyewear is recommended.
- It is recommended to locate PhoXi scanners in an environment that restricts laser light exposure to the surrounding area. Mirrors, polished surfaces, and similar objects should be removed from the vicinity of the laser scanner to avoid accidental exposure by reflection.



WARNING

The surface of the PhoXi 3D processing unit becomes hot to touch when the device is in use. Mount the device on a metal mounting plate that will act as a thermal bridge to dissipate the heat and use the camera's carbon body to adjust the device.



The cameras include power and data cables, with the following OMRON part numbers.

3D Camera, part numbers 21857-100, -200, -300 include the following:

- Scanner + PoE injector + cable: 21844-100, -200, -300
- Programmed License Key: 22869-000
- Ethernet cable (3 m): 81030-001

Before connecting cables to the camera, it must be mounted onto the work space. Use the following figure to properly mount the 3D camera for your application.

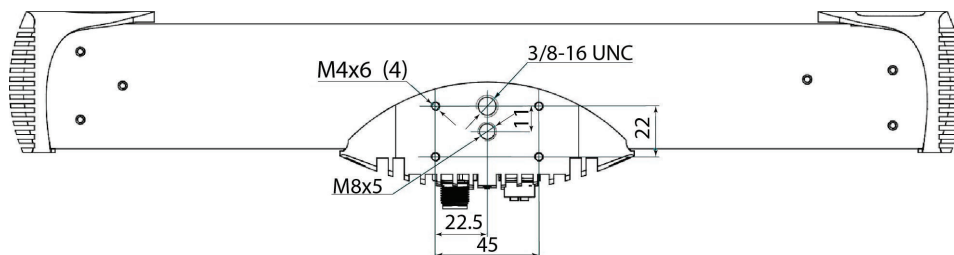

The suggested mounting method for heat dissipation is to use the 4 x M4 screws with a metal mounting plate of suitable size. Ensure the mounting plate is rigid to avoid vibrations during scanning. The optimal operating temperature for scanning is 22 °C to 25 °C; while the operating temperature range is 0 °C to 45 °C.

The following information shows the PhoXi camera connections. The following tables provide details about each pin and any cable requirements.



Precautions for Correct Use

Always use cables of a Cat5e category or higher that support Gigabit Ethernet or 10 Gigabit Ethernet standards. Do not use Cat5 category cables as their speed is usually 10 - 100 Mbps. This is too low to obtain good scanning performance. When connecting a camera to a switch, make sure the switch can operate at speeds of 1 Gbps or more.



Precautions for Correct Use

Connect the network cable to the scanner first, followed by the power cable.

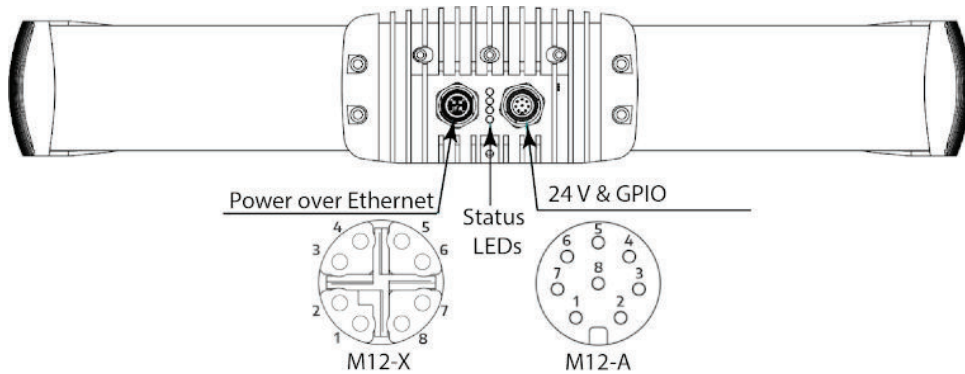

Item	Wire Color	Pin Out	Function
1	White	DC In	+24 VDC
2	Brown	Opto IN2 GND	Laser interlock ground
3	Green	GND	Ground
4	Yellow	Opto IN 1	
5	Grey	Opto IN 1 Ground	
6	Pink	Opto Out	
7	Blue	Opto Out GND	
8	Red	Opto IN 2	Laser interlock signal



Additional Information

- Wire colors indicated in the table above correspond to the cable supplied with the camera.
- The laser interlock ground and signal functions require special firmware.

The M12-X PoE port is the recommended powering option. It has a 1 Gbps connection to the PoE injector input port.



Precautions for Correct Use

POE power requires the use of the included POE Injector. If users attempt to power the camera via a standard IPC Ethernet port, the IPC Ethernet port may be damaged.

Connector	MX12 X	M12 A
PoE Standard	DC IN	+24 VDC
PoE Standard	IEEE802.3at	
Operating Voltage DC	min. 55 Vt	24 V (20-30 V)
Residual ripple max.	0.5%	2%
Rated operating current	0.36 A (0.6 A)	1 A (2 A)

Connector	MX12 X	M12 A
Minimum Power	33 W	60 W
Shielding	Fully Shielded RJ45	
Data transfer rate		
Max. cable length	20 m	20 m (see Additional Information)



Precautions for Correct Use

For cables over 10 meters in length, ensure the operating voltage is at a minimum of 28 VDC.

3-2-1 Photoneo 3D Camera Indicators

The Photoneo 3D camera has four status LEDs on the connector side of the device. The following figure provides the LED signals and corresponding camera statuses.

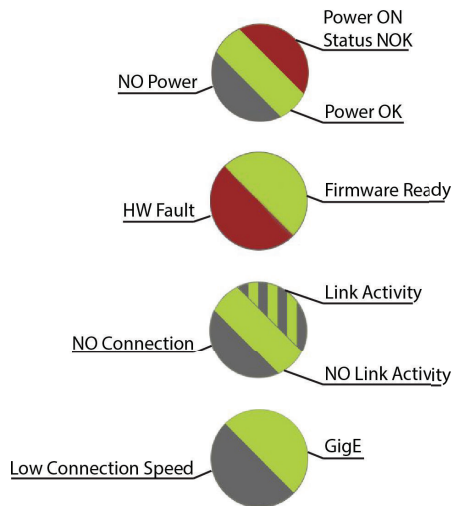

3-3 Photoneo 3D Software Configuration

The ACE software installation includes the PhoXi Control tool that is required for the camera configuration.



Precautions for Correct Use

Do not access the camera with the ACE software and PhoXi Control simultaneously. While it is possible to simultaneously access the 3D camera through the ACE Software and PhoXi Control, changing camera settings in PhoXi Control while running the ACE software may result in unexpected camera and system behavior.

3-3-1 Configure Camera Settings

Use the information below to make camera settings before adding the camera to the ACE project.

- 1 From the Windows Start Menu, navigate to and open the PhoXi Control application.
- 2 Verify that the camera is connected and that the device status is ready.

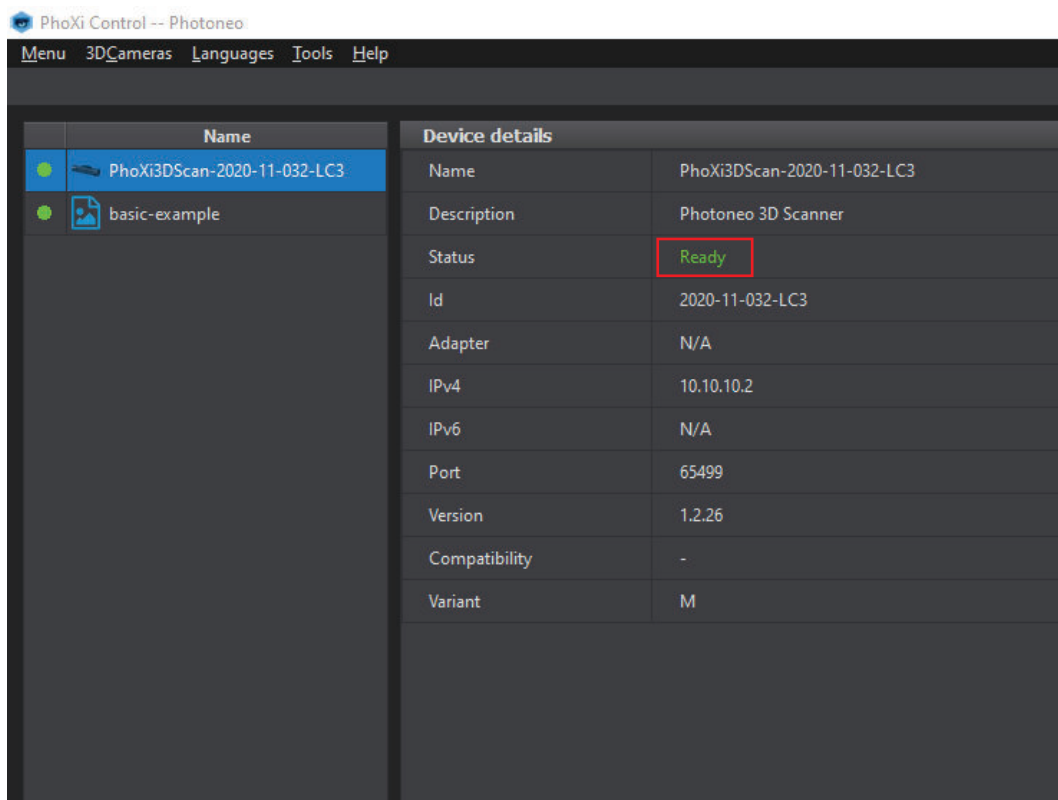

- 3 Click the **Configure** Button to configure the camera's static IP address to match the IPC. The PhoXi camera has limited IP address parameters based on class A, B, and C, as shown below.

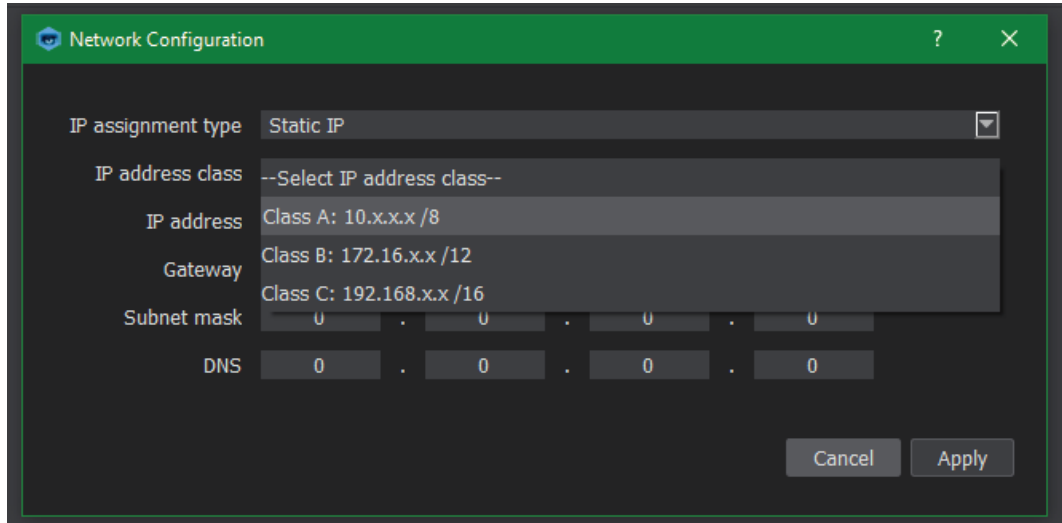

- 4 Click the **Connect** Button to open the *Device Window* and adjust camera settings as desired.

4

Configuring FH/FHV 2D Cameras

This section provides information about configuring FH/FHV cameras to work with the ACE software.

4

4-1	FH/FHV Camera Configuration Overview	4-2
4-2	Data Exchange Diagram	4-3
4-3	FH/FHV Camera Connections	4-4
4-3-1	FH/FHV Camera Connection Procedure	4-4
4-4	FH/FHV Software Configuration.....	4-5
4-4-1	FH/FHV Camera Location Array and Variables.....	4-5

4-1 FH/FHV Camera Configuration Overview

ACE Robot Vision Manager tools support FH/FHV cameras supplied by OMRON. These cameras need configuration prior to use with the ACE software.

Complete the following steps to configure FH/FHV cameras.

- 1** Complete the camera's power and communication connections.
- 2** Configure the camera's software.
- 3** After connecting and configuring the camera, the camera can be added to the ACE project.



Additional Information

Refer to the *Automation Control Environment (ACE) Version 4 User's Manual (Cat. No. I633)* for more information on adding a camera to an ACE project.

4-2 Data Exchange Diagram

A diagram showing data exchange between FH / FHV objects and other components is shown below.

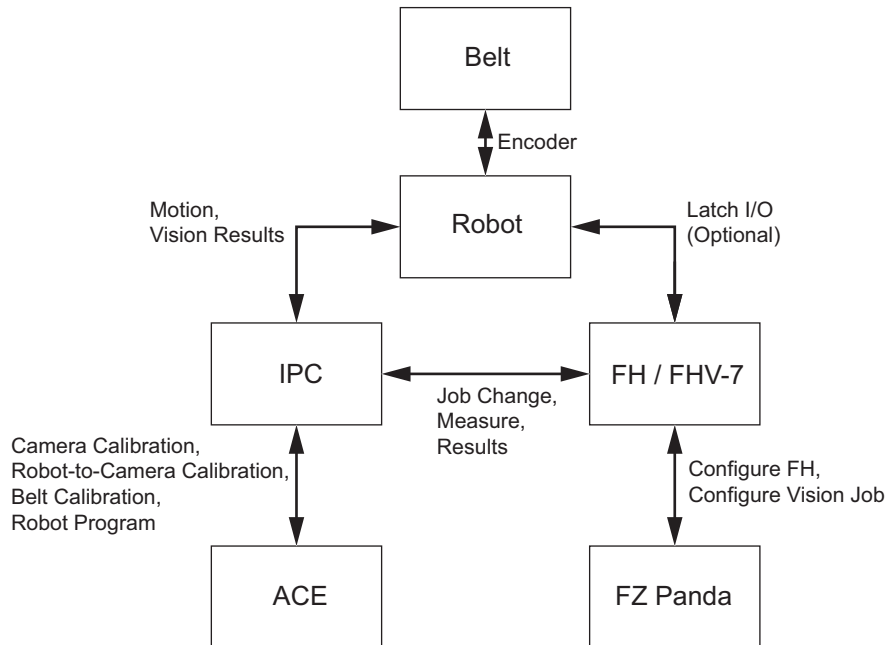

4-3 FH/FHV Camera Connections

WARNING

Improper installation or wiring misconfiguration of the Camera Power Supply could result in electrical shock hazard. You must ensure the safe and proper installation of the Camera Power Supply in accordance with the applicable rules and regulations, and by qualified personnel.



Refer to the *FH Series Vision System Hardware Setup Manual (Cat. No. Z366)* for the correct steps and installation requirements to establish communication and power connections with your specific camera.

4-3-1 FH/FHV Camera Connection Procedure

The following is a summary of the connection procedure as described further in the *FH Series Vision System Hardware Setup Manual (Cat. No. Z366)*.

- 1** Add Location Array in FH/FHV Launcher.
- 2** Associate Array to Locator Tool.
- 3** Setup Output Messages.
- 4** Add FH Tool AceObject in the ACE software.
- 5** Set configuration.
- 6** Pixel calibration.

4-4 FH/FHV Software Configuration

The FH/FHV Launcher configuration tool is used to configure FH/FHV cameras. This software can be downloaded from the OMRON website.

Use the information below to make camera settings before adding the camera to the ACE project.



Precautions for Correct Use

The ACE software and FH/FHV Launcher cannot access a camera simultaneously. Always disconnect FH/FHV Launcher before opening an ACE project with an FH/FHV camera object present.

4-4-1 FH/FHV Camera Location Array and Variables

After connecting the FH/FHV camera to the power source and computer, a location array must be added. Follow the steps below to add a location array after the camera is powered on.

- 1 Open the FH/FHV Launcher application from the FZ Panda program group and connect to the camera.
- 2 Once connected, open the TDM Editor and then click the **Scene Variable** Tab.
- 3 Add a Double Array for the X, Y, RZ and 32 elements.

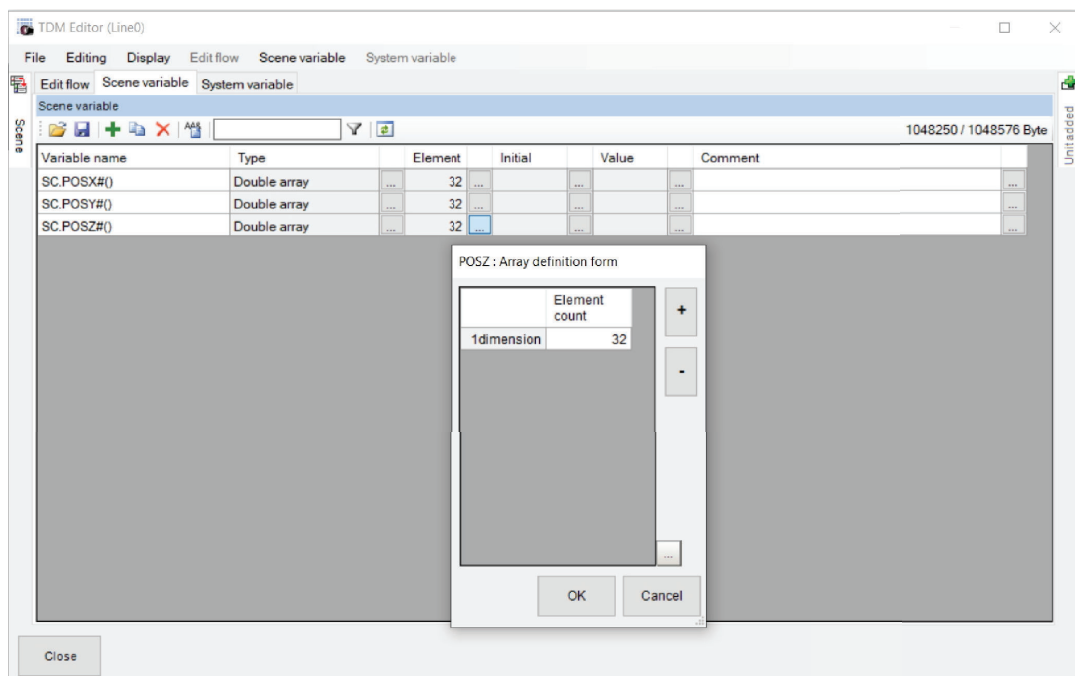

Associate Variables

After the array is created, associate each array element with the corresponding *Search Job* output variable.

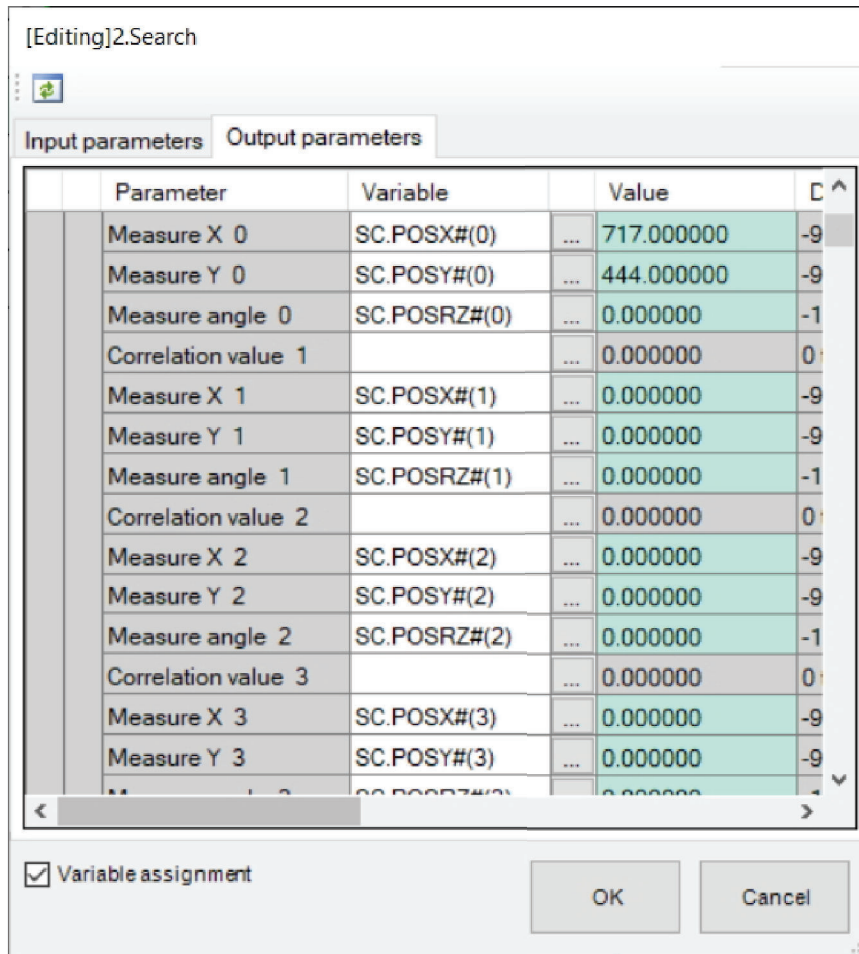

- 1 Open the TDM editor and click **Edit Flow**.
- 2 Select **Search Job** and then edit with the New Editor.
- 3 Open the *Output Parameters* and then check the **Variable Assignment** Box, as shown in the bottom left of the above figure.
- 4 Click the triple dots next to *Measure_* in the *Parameter* column and select the corresponding **Variable Array** element.
- 5 Assign the corresponding *Variable Array* element for each *Parameter*.

Setup Output Messages

The TDM editor is used to setup the output messages, as defined in the following steps.

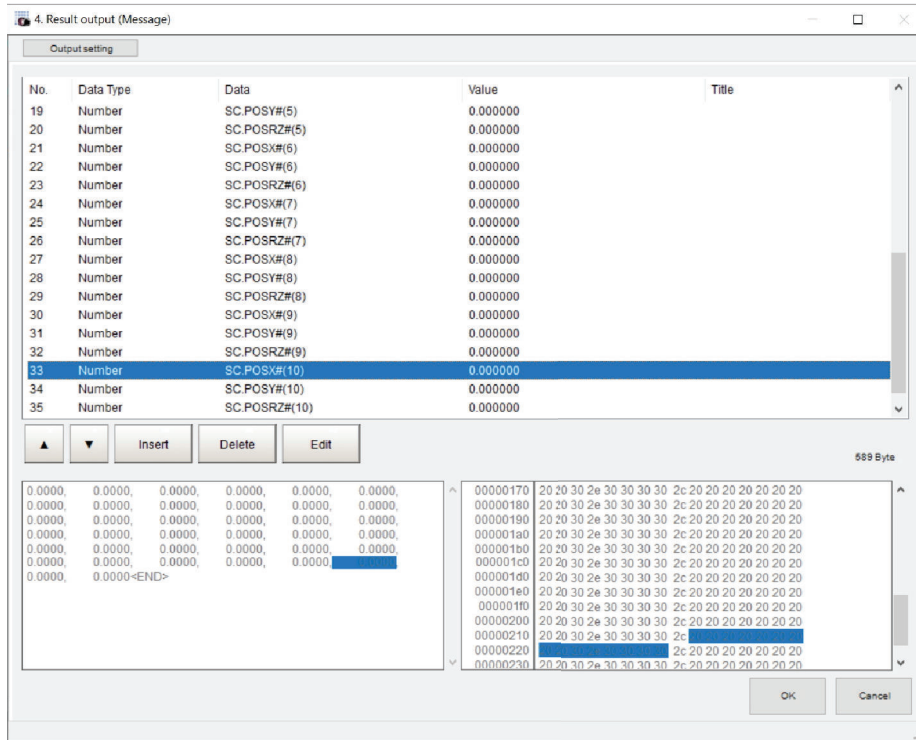

- 1 Open the *TDM Editor* and select **Edit Flow**.
- 2 When opened, add Result Output (Parallel).
- 3 Open the editor and then set **Data Separator**, **Data Terminator**, and Port.
- 4 Click **Insert** and add each variable element in order, using the number option. As an example, x1, y1, rz1, m1, x2, y2, rz2, m2.
- 5 Once done, Click **OK**, click **Save**, and then close the FH/FHV Launcher.

5

Configuring FH-SMD 3D Cameras

This section provides information about configuring FH-SMD 3D cameras to work with the ACE software.

5-1	FH-SMD Camera Configuration Overview	5-2
5-2	FH-SMD Camera Connections	5-3
5-3	FH-SMD Software Configuration.....	5-4
5-3-1	Configure Network Settings.....	5-4

5-1 FH-SMD Camera Configuration Overview

ACE Robot Vision Manager tools support FH-SMD cameras supplied by OMRON. These cameras need configuration prior to use with the ACE software.

Complete the following steps to configure FH-SMD cameras.

- 1** Complete the camera's power and communication connections.
- 2** Configure the camera's software.
- 3** After connecting and configuring the camera, the camera can be added to the ACE project.



Additional Information

Refer to the *Automation Control Environment (ACE) Version 4 User's Manual (Cat. No. I633)* for more information on adding a camera to an ACE project.

5-2 FH-SMD Camera Connections

WARNING

Improper installation or wiring misconfiguration of the Camera Power Supply could result in electrical shock hazard. You must ensure the safe and proper installation of the Camera Power Supply in accordance with the applicable rules and regulations, and by qualified personnel.



Refer to the *FH Series Vision System Hardware Setup Manual for 3D Robot Vision (Cat. No. Z436)* for the correct steps and installation requirements to establish communication and power connections with the FH-SMD camera.

5-3 FH-SMD Software Configuration

The ACE software installation includes the Sentech StViewer utility that is required for the camera configuration. Use the information below to make camera settings before adding the camera to the ACE project.



Precautions for Correct Use

The ACE software and StViewer tool cannot access a camera simultaneously. Always disconnect the StViewer tool before opening an ACE project with an FH-SMD camera object present.

5-3-1 Configure Network Settings

Use these steps to establish communication connections between the IPC and the FH-SMD camera.



Additional Information

An FH-5050 Sensor Controller is not required to use the FH-SMD camera with ACE. Instead, the camera is connected directly to ACE on the IPC.

- 1** Access the *Window's Control Panel* on the IPC.
- 2** Select **All Control Panel Items** and then select **Network Connections**.
- 3** Right click on the desired network, select **Properties**, select **Configure**, and then select the **Advanced** Tab.
- 4** Select **Jumbo Packet** from the Property list and change the Jumbo Packet value to 9014 Bytes as shown in the image below.

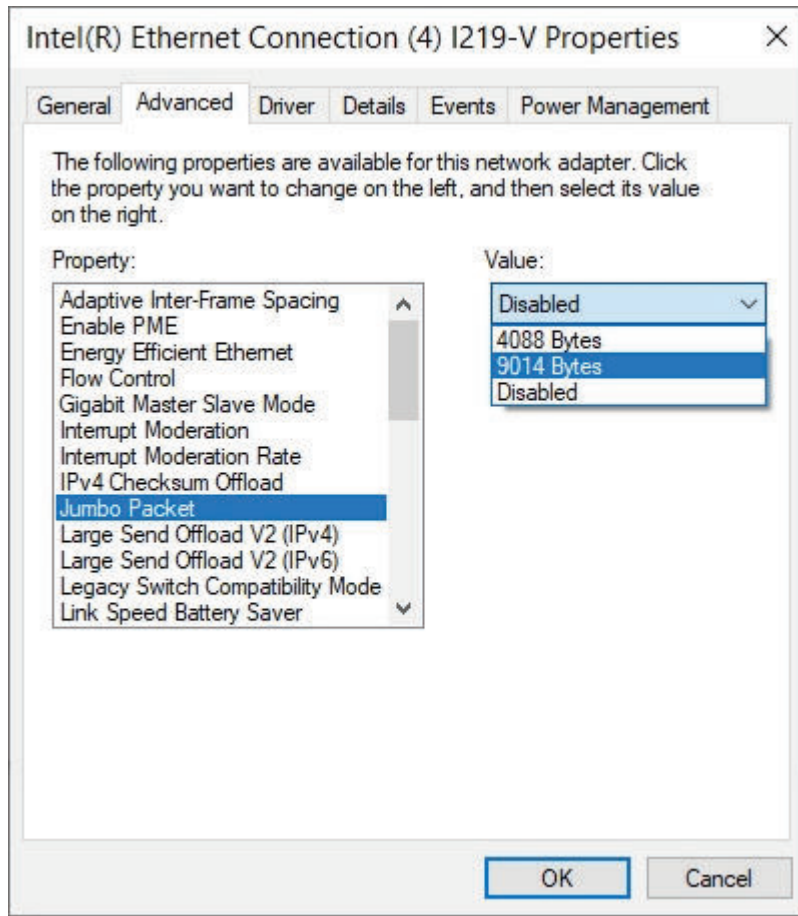

- 5 In the Windows Start Menu, navigate to and open the STViewer application.
- 6 Click on the camera and then select **Set Address**.
- 7 Set the camera to the desired IPv4, Subnet, and Gateway Address and click **OK** to open the camera view.

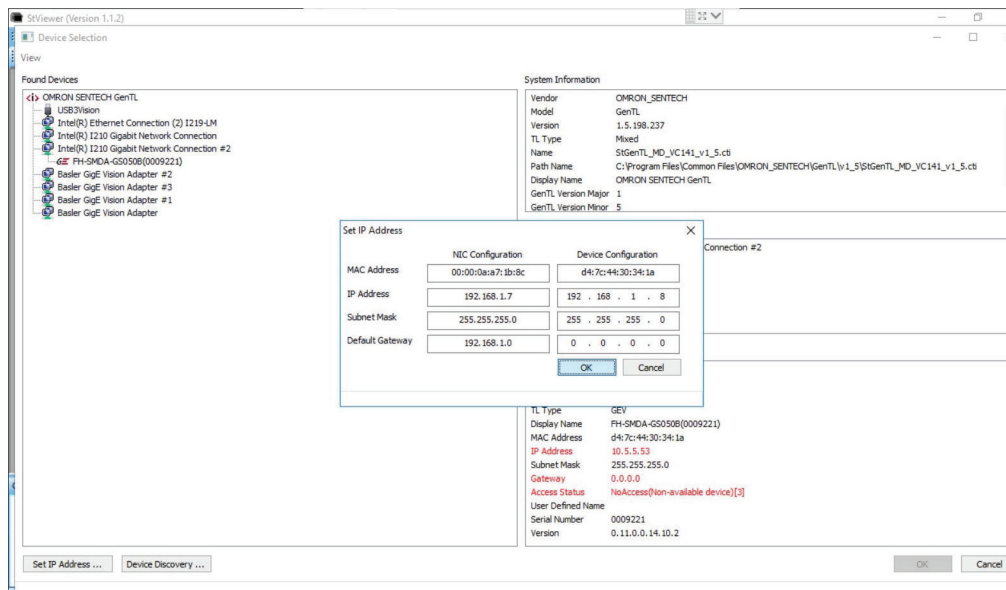

- 8 Click the **Play** Button, and then the **Stop** Button to save the camera's settings.

9 Click **File** and then select **Exit**.

10 Refer to the *Automation Control Environment (ACE) Version 4 User's Manual (Cat. No. I633)* to complete configuration within ACE.



Camera Latch Signal Test

This section provides information on latch signal tests for all ACE-supported 2D GigE cameras.

6-1	Latch Signal Test Procedure	6-2
------------	--	------------

6-1 Latch Signal Test Procedure

The Latch Signal Test is a simple test that can be performed for each camera in an application before proceeding with calibrations.

The following settings and configurations must be complete before the test is administered.

- Camera communication and power supply is present.
- Network and camera settings are complete.
- The camera object must be present and configured in the ACE project.
- The position latch signal connections must be present.

Use the following procedure to test a latch signal.

- 1** Access the Monitor Window. Refer to the *Automation Control Environment (ACE) Version 4 User's Manual (Cat. No. I633)* for more information.
- 2** Clear the latch FIFO buffer using the program keyword CLEAR.LATCHES.
For belts, use "do@1 clear.latches(-n)" where "n" is the belt object number.
For robots, use "do@1 clear.latches(+n)" where "n" is the robot number. Refer to the *V+ Keyword Reference Manual (Cat. No. I672)* for more information.
- 3** Ensure the latch FIFO buffer is empty by entering "listr latched(-n)" or "listr latched(+n)", where "n" is the same as in step 2. This should return "0" if the FIFO buffer is clear. If not repeat step 2 and 3, or confirm the latch signal was wired and configured properly.
- 4** Trigger the camera by clicking the **Run** Button in the Virtual Camera object. Enter "listr latched(-n)" or "listr latched(+n)" respectively to return the most recent latch signal from the FIFO buffer. For the example circuit and configuration described above on Encoder Channel 0, "listr latched(-1)" would return "1001". If this occurs, the test procedure is successful and complete.

OMRON Corporation Industrial Automation Company

Kyoto, JAPAN

Contact : www.ia.omron.com

Regional Headquarters

OMRON EUROPE B.V.

Wegalaan 67-69, 2132 JD Hoofddorp
The Netherlands
Tel: (31) 2356-81-300 Fax: (31) 2356-81-388

OMRON ASIA PACIFIC PTE. LTD.

438B Alexandra Road, #08-01/02 Alexandra
Technopark, Singapore 119968
Tel: (65) 6835-3011 Fax: (65) 6835-3011

OMRON ELECTRONICS LLC

2895 Greenspoint Parkway, Suite 200
Hoffman Estates, IL 60169 U.S.A.
Tel: (1) 847-843-7900 Fax: (1) 847-843-7787

OMRON ROBOTICS AND SAFETY TECHNOLOGIES, INC.

4225 Hacienda Drive, Pleasanton, CA 94588 U.S.A.
Tel: (1) 925-245-3400 Fax: (1) 925-960-0590

OMRON (CHINA) CO., LTD.

Room 2211, Bank of China Tower, 200 Yin Cheng Zhong Road,
PuDong New Area, Shanghai, 200120, China
Tel: (86) 21-6023-0333 Fax: (86) 21-5037-2388

Authorized Distributor:

©OMRON Corporation 2023 All Rights Reserved.
In the interest of product improvement,
specifications are subject to change without notice.

Cat. No. I679-E-02 1124 (0822)

24217-000 B