

Machine Automation Controller

NJ/NX-series

CPU Unit

OPC UA

User's Manual

NJ501-1□□00

NX102-□□□□

NX502-1□□00

NX701-1□□□



NOTE

1. All rights reserved. No part of this publication may be reproduced, stored in a retrieval system, or transmitted, in any form, or by any means, mechanical, electronic, photocopying, recording, or otherwise, without the prior written permission of OMRON.
2. No patent liability is assumed with respect to the use of the information contained herein. Moreover, because OMRON is constantly striving to improve its high-quality products, the information contained in this manual is subject to change without notice.
3. Every precaution has been taken in the preparation of this manual. Nevertheless, OMRON assumes no responsibility for errors or omissions. Neither is any liability assumed for damages resulting from the use of the information contained in this publication.

Trademarks

- Sysmac and SYSMAC are trademarks or registered trademarks of OMRON Corporation in Japan and other countries for OMRON factory automation products.
- Microsoft, Windows, Excel, Visual Basic, and Microsoft Edge are either registered trademarks or trademarks of Microsoft Corporation in the United States and other countries.
- EtherCAT® is registered trademark and patented technology, licensed by Beckhoff Automation GmbH, Germany.
- ODVA, CIP, CompoNet, DeviceNet, and EtherNet/IP are trademarks of ODVA.
- The SD and SDHC logos are trademarks of SD-3C, LLC. 

Other company names and product names in this document are the trademarks or registered trademarks of their respective companies.

Copyrights

- Microsoft product screen shots used with permission from Microsoft.
- This product incorporates certain third party software. The license and copyright information associated with this software is available at http://www.fa.omron.co.jp/nj_info_e/.

Introduction

Thank you for purchasing an NJ/NX-series CPU Unit.

This manual contains information that is necessary to use the OPC UA with the NJ/NX-series CPU Unit. Please read this manual and make sure you understand the functionality and performance of the NJ/NX-series CPU Unit before you attempt to use it in a control system.

Keep this manual in a safe place where it will be available for reference during operation.

Intended Audience

This manual is intended for the following personnel, who must also have knowledge of electrical systems (an electrical engineer or the equivalent).

- Personnel in charge of introducing FA systems.
- Personnel in charge of designing FA systems.
- Personnel in charge of installing and maintaining FA systems.
- Personnel in charge of managing FA systems and facilities.

For programming, this manual is intended for personnel who understand the programming language specifications in international standard IEC 61131-3 or Japanese standard JIS B 3503.

Applicable Products

This manual covers the following products.

- NX-series CPU Units NX701-1□□□ (Unit version 1.24 or later)
- NX-series CPU Units NX502-1□00 (Unit version 1.60 or later)
- NX-series CPU Units NX102-□□□□ (Unit version 1.30 or later)
- NJ-series CPU Units NJ501-1□00 (Unit version 1.17 or later)
- Sysmac Studio SYSMAC-SE2□□□
(NX701-1□□□: Version 1.44 or higher, NX502-1□00: Version 1.54 or higher, NX102-□□00: Version 1.23 or higher, NX102-□□20: Version 1.24 or higher, and NJ501-1□00: Version 1.21 or higher)

Part of the specifications and restrictions for the CPU Units are given in other manuals. Refer to *Relevant Manuals* on page 2 and *Related Manuals* on page 20.

Relevant Manuals

The following table provides the relevant manuals for the NJ/NX-series CPU Units. Read all of the manuals that are relevant to your system configuration and application before you use the NJ/NX-series CPU Unit.

The built-in EtherNet/IP port in the NJ/NX-series CPU Unit is used for this product. For details on how to use the built-in EtherNet/IP port, refer to the *NJ/NX-series CPU Unit Built-in EtherNet/IP Port User's Manual (Cat. No. W506)*.

Most operations are performed from the Sysmac Studio Automation Software. Refer to the *Sysmac Studio Version 1 Operation Manual (Cat. No. W504)* for information on the Sysmac Studio.

Purpose of use	Manual											
	Basic information					NJ/NX-series Instructions Reference Manual	NJ/NX-series CPU Unit Motion Control User's Manual	NJ/NX-series Motion Control Instructions Reference Manual	NJ/NX-series CPU Unit Built-in EtherCAT Port User's Manual	NJ/NX-series CPU Unit Built-in EtherNet/IP Port User's Manual	NJ-series CPU Unit OPC UA User's Manual	NJ/NX-series Troubleshooting Manual
	NX-series CPU Unit Hardware User's Manual	NX-series NX502 CPU Unit Hardware User's Manual	NX-series NX102 CPU Unit Hardware User's Manual	NJ-series CPU Unit Hardware User's Manual	NJ/NX-series CPU Unit Software User's Manual							
Introduction to NX701 CPU Units	○											
Introduction to NX502 CPU Units		○										
Introduction to NX102 CPU Units			○									
Introduction to NJ-series Controllers				○								
Setting devices and hardware												
Using motion control						○						
Using EtherCAT	○	○	○	○				○				
Using EtherNet/IP									○			
Software settings												
Using motion control						○						
Using EtherCAT					○			○				
Using EtherNet/IP									○			
Using OPC UA										○		
Writing the user program												
Using motion control							○	○				
Using EtherCAT						○			○			
Using EtherNet/IP										○		
Programming error processing												○
Using OPC UA											○	
Testing operation and debugging												
Using motion control							○					
Using EtherCAT						○			○			
Using EtherNet/IP										○		
Using OPC UA											○	

Purpose of use	Manual											
	Basic information					NJ/NX-series Instructions Reference Manual	NJ/NX-series CPU Unit Motion Control User's Manual	NJ/NX-series Motion Control Instructions Reference Manual	NJ/NX-series CPU Unit Built-in EtherCAT Port User's Manual	NJ/NX-series CPU Unit Built-in EtherNet/IP Port User's Manual	NJ-series CPU Unit OPC UA User's Manual	NJ/NX-series Troubleshooting Manual
	NX-series CPU Unit Hardware User's Manual	NX-series NX502 CPU Unit Hardware User's Manual	NX-series NX102 CPU Unit Hardware User's Manual	NJ-series CPU Unit Hardware User's Manual	NJ/NX-series CPU Unit Software User's Manual							
Learning about error management and corrections*1	△	△	△	△	△		△		△	△		○
Maintenance												
Using motion control	○	○	○	○			○					
Using EtherCAT								○				
Using EtherNet/IP									○			

*1. Refer to the *NJ/NX-series Troubleshooting Manual (Cat. No. W503)* for the error management concepts and an overview of the error items. Refer to the manuals that are indicated with triangles for details on errors for the corresponding Units.

Manual Structure

Page Structure

The following page structure is used in this manual.

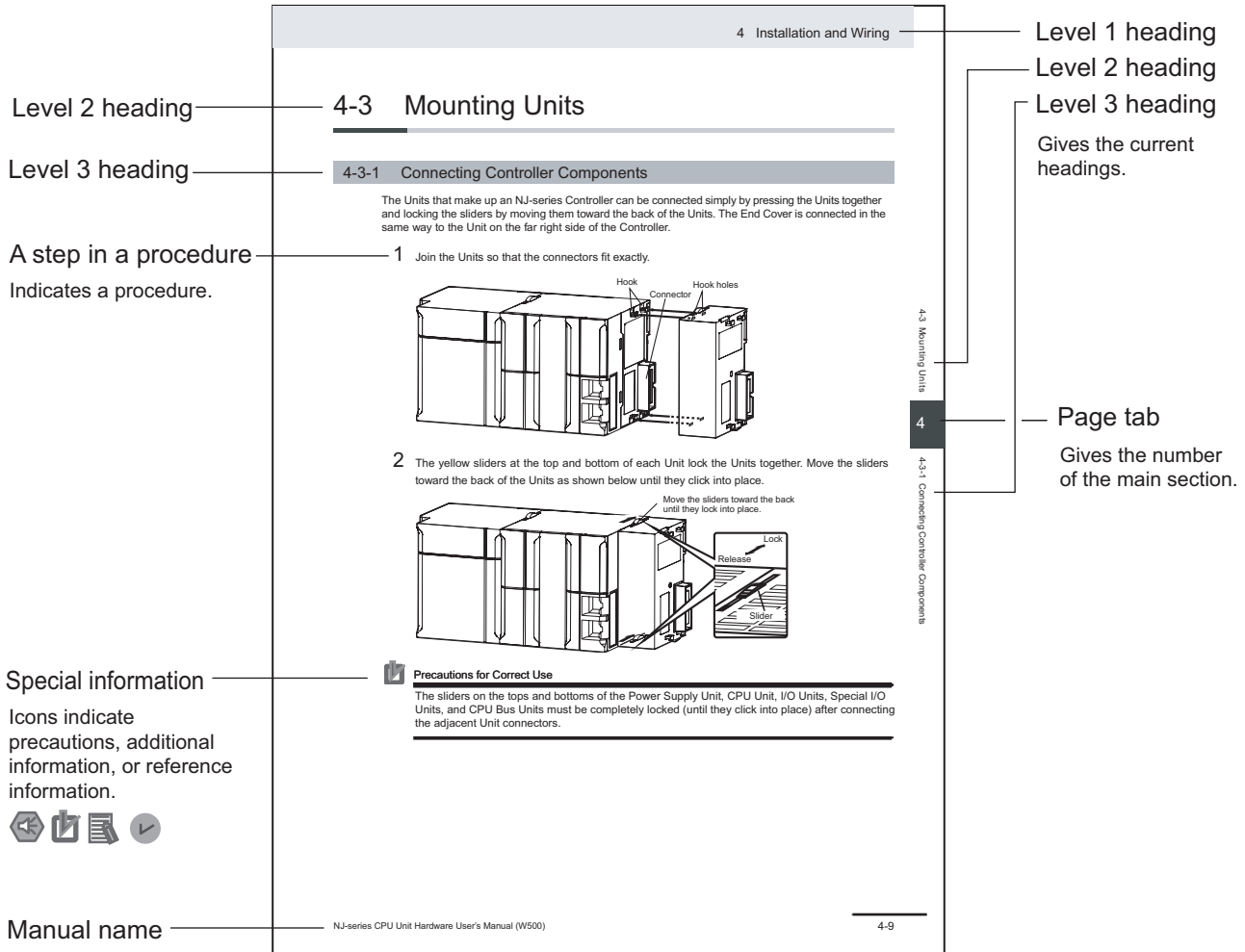

This illustration is provided only as a sample. It may not literally appear in this manual.

Special Information

Special information in this manual is classified as follows:



Precautions for Safe Use

Precautions on what to do and what not to do to ensure safe usage of the product.



Precautions for Correct Use

Precautions on what to do and what not to do to ensure proper operation and performance.



Additional Information

Additional information to read as required.

This information is provided to increase understanding or make operation easier.



Version Information

Information on differences in specifications and functionality for Controller with different unit versions and for different versions of the Sysmac Studio is given.

Precaution on Terminology

- In this manual, *built-in EtherNet/IP port* refers to the following port.
 - Built-in EtherNet/IP port (PORT 1) of the NX-series CPU Units NX701-1□□□
 - Built-in EtherNet/IP port (PORT 1) of the NX-series CPU Units NX502-1□00
 - Built-in EtherNet/IP port (PORT 1) of the NX-series CPU Units NX102-□□□□
 - Built-in EtherNet/IP port of the NJ-series CPU Units NJ501-1□00
- In this manual, *download* refers to transferring data from the Sysmac Studio to the physical Controller and *upload* refers to transferring data from the physical Controller to the Sysmac Studio. For the Sysmac Studio, *synchronization* is used to both *upload* and *download* data. Here, *synchronize* means to automatically compare the data for the Sysmac Studio on the computer with the data in the physical Controller and transfer the data in the direction that is specified by the user.

Sections in this Manual

1	Overview of OPC UA Server Function	A	Appendices	1	A
2	Structure of the OPC UA Server	I	Index	2	I
3	Settings of the OPC UA Server			3	
4	Starting and Checking the Status of the OPC UA Server			4	
5	Security Function of OPC UA Server			5	
6	Connecting from the OPC UA Client and Reading/Writing Variables			6	
7	Execution Log Functions			7	
8	Other Functions			8	
9	Troubleshooting			9	

CONTENTS

Introduction	1
Intended Audience	1
Applicable Products	1
Relevant Manuals	2
Manual Structure	4
Page Structure	4
Special Information	4
Precaution on Terminology	5
Sections in this Manual	7
Terms and Conditions Agreement	12
Warranty, Limitations of Liability	12
Application Considerations	13
Disclaimers	13
Statement of security responsibilities for assumed use cases and against threats	14
Safety Precaution	15
Precautions for Safe Use	16
Precautions for Correct Use	17
Regulations and Standards	18
Software Licenses and Copyrights	18
Versions	19
Unit Versions of CPU Units and the Sysmac Studio Versions	19
Related Manuals	20
Terminology	22
Revision History	24

Section 1 Overview of OPC UA Server Function

1-1 Overview and Features	1-2
1-1-1 Overview	1-2
1-1-2 System Configuration	1-2
1-1-3 Features	1-2
1-2 Specifications	1-4
1-2-1 List of Supported CPU Units	1-4
1-2-2 Function Specifications	1-4
1-3 OPC UA Server Procedures	1-8
1-3-1 Overall Procedure	1-8
1-3-2 Procedure Details	1-9

Section 2 Structure of the OPC UA Server

2-1	Internal Structure of the Overall OPC UA Communications System	2-2
2-1-1	Overview	2-2
2-1-2	Details	2-2
2-2	Overview of the Security Function of the OPC UA Server	2-5

Section 3 Settings of the OPC UA Server

3-1	Controller Setup	3-2
3-1-1	IP Address Settings of the Built-in EtherNet/IP Port	3-2
3-2	OPC UA Settings	3-3
3-2-1	Overview of OPC UA Settings	3-3
3-2-2	OPC UA Server Settings	3-5
3-2-3	When Necessary to Cycle the Power Supply to the Controller or Reset the Controller	3-11
3-2-4	Automatic Generation of the Server Certificate	3-12
3-2-5	Setting and Displaying the Certificate	3-12
3-2-6	Security Settings	3-24
3-2-7	Server Status	3-31
3-2-8	Displaying the Operation Logs	3-31
3-2-9	Operations for the OPC UA Settings	3-32
3-3	Creating Variables for OPC UA Communications	3-33
3-3-1	Global Variables Published to OPC UA Communications	3-33
3-3-2	Variables in User-defined Function Blocks Published to OPC UA Communications	3-34
3-3-3	Variables Based on Companion Specifications Published to OPC UA Communications	3-36
3-3-4	Differences in Method to Publish Variables between User-defined and Companion Specifications	3-38
3-3-5	Adding or Deleting Network-published Variables	3-39

Section 4 Starting and Checking the Status of the OPC UA Server

4-1	Starting or Stopping the OPC UA Server	4-2
4-1-1	How to Start or Stop the OPC UA Server	4-2
4-1-2	Conditions under Which the OPC UA Server Cannot be Started	4-3
4-1-3	Conditions under Which the OPC UA Server Stops	4-3
4-1-4	Operation of the OPC UA Service Function in each State of the CPU Unit	4-4
4-2	Checking the Status of the OPC UA Server	4-5
4-2-1	Checking Based on OPC UA Server Status of the Sysmac Studio	4-5
4-2-2	Checking Based on the Event Log	4-7
4-2-3	Checking Based on the Execution Log	4-7
4-2-4	Operating Status of the OPC UA Server	4-7
4-2-5	Conditions for Reconfiguring the OPC UA Server	4-9

Section 5 Security Function of OPC UA Server

5-1	Details of the Connection Authentication Function of the OPC UA Server	5-2
5-1-1	Application Authentication	5-2
5-1-2	User Authentication	5-5
5-1-3	Role Function	5-6
5-2	Details of the Message Security Function	5-9
5-2-1	Signature and Encryption	5-9
5-2-2	OPC UA Security Mode and Policy	5-9

Section 6 Connecting from the OPC UA Client and Reading/Writing Variables

6-1	Connecting from the OPC UA Client.....	6-2
6-1-1	Specifying the URL of the Target OPC UA Server	6-2
6-1-2	Connecting to the Target OPC UA Server.....	6-2
6-2	Reading/Writing Variables from the OPC UA Client	6-3
6-2-1	Address Space of the NJ/NX-series Controller	6-3
6-2-2	Reading/Writing the Variables of the CPU Unit	6-5

Section 7 Execution Log Functions

7-1	Execution Logs	7-2
7-1-1	Overview	7-2
7-1-2	How to Use the Execution Log.....	7-3
7-1-3	Setting the Execution Log	7-4
7-1-4	Checking the Execution Log	7-4
7-1-5	Execution Log File Specifications	7-4
7-1-6	Format of Records	7-5
7-1-7	Examples of Records in Execution Log File.....	7-13
7-2	Checking the Execution Log.....	7-15
7-2-1	How to Check the Execution Log	7-15
7-2-2	Checking Logs in the Operation Log Window in the Sysmac Studio	7-15
7-2-3	Checking Logs with the SD Memory Card	7-18
7-2-4	Checking Logs by Using FTP Client Software	7-18
7-3	OPC UA Server Shutdown Function	7-20
7-3-1	Overview	7-20
7-3-2	Shutdown System	7-20
7-3-3	How to Execute the Shutdown Function	7-21
7-3-4	How to Check the Shutdown of the OPC UA Server	7-21
7-4	SD Memory Card Operations	7-22
7-4-1	Conditions for Saving Execution Log Files to the SD Memory Card.....	7-22
7-4-2	Directories Used for the OPC UA Server	7-22
7-4-3	Execution Log Operation When Replacing the SD Memory Card	7-22
7-4-4	Approximate Work Time for SD Memory Card Replacement.....	7-23
7-4-5	Replacement Timing of SD Memory Card.....	7-23

Section 8 Other Functions

8-1	The Sysmac Studio Operation Authority Verification Related to the OPC UA Server	8-2
8-2	Backup and Restore Functions Related to the OPC UA Server.....	8-4
8-2-1	Backup Function	8-4
8-2-2	Restoration and Verification	8-5
8-2-3	Compatibility between Backup-related Files	8-7
8-2-4	How to Replace the CPU Unit in Relation to the OPC UA Server	8-7
8-3	Clear All Memory Function Related to the OPC UA Server	8-9

Section 9 Troubleshooting

9-1	Overview of Troubleshooting	9-2
------------	--	------------

Appendices

A-1	Task Design Procedure	A-2
A-1-1	Startup Time of the OPC UA Server (Reference Values).....	A-2
A-1-2	Guidelines for System Service Execution Time Ratio	A-6
A-1-3	Checking the System Service Execution Time Ratio	A-7
A-2	OPC UA Instructions	A-9
A-2-1	OPCUA_Shutdown (Shutdown OPC UA Function)	A-9
A-2-2	Variables.....	A-9
A-2-3	Related System-defined Variables	A-10
A-2-4	Related Error Codes	A-10
A-2-5	Function	A-10
A-2-6	Precautions for Correct Use	A-10
A-2-7	Additional Information	A-11
A-2-8	Sample Programming	A-11
A-3	When CA-signed Client Certificates Supported	A-14
A-3-1	Overview	A-14
A-3-2	Setting	A-15
A-3-3	Related Operations Performed from OPC UA Settings in the Sysmac Studio.....	A-15
A-4	List of Related System-defined Variables	A-20
A-4-1	System-defined Variables for the Overall NJ/NX-series Controller (No Category).....	A-20
A-5	Support for OPC UA for PackML Specifications	A-21
A-5-1	Range of Compatible OPC UA for PackML Specifications	A-21
A-5-2	What You Need When Using OPC UA for PackML.....	A-21
A-5-3	OPC UA for PackML Information Model	A-21
A-6	Version Information	A-27
A-6-1	Relationship between Unit Versions and OPC UA Standard Versions	A-27
A-6-2	Relationship between Unit Versions and the Sysmac Studio Versions.....	A-27

Index

Terms and Conditions Agreement

Warranty, Limitations of Liability

Warranties

● Exclusive Warranty

Omron's exclusive warranty is that the Products will be free from defects in materials and workmanship for a period of twelve months from the date of sale by Omron (or such other period expressed in writing by Omron). Omron disclaims all other warranties, express or implied.

● Limitations

OMRON MAKES NO WARRANTY OR REPRESENTATION, EXPRESS OR IMPLIED, ABOUT NON-INFRINGEMENT, MERCHANTABILITY OR FITNESS FOR A PARTICULAR PURPOSE OF THE PRODUCTS. BUYER ACKNOWLEDGES THAT IT ALONE HAS DETERMINED THAT THE PRODUCTS WILL SUITABLY MEET THE REQUIREMENTS OF THEIR INTENDED USE.

Omron further disclaims all warranties and responsibility of any type for claims or expenses based on infringement by the Products or otherwise of any intellectual property right.

● Buyer Remedy

Omron's sole obligation hereunder shall be, at Omron's election, to (i) replace (in the form originally shipped with Buyer responsible for labor charges for removal or replacement thereof) the non-complying Product, (ii) repair the non-complying Product, or (iii) repay or credit Buyer an amount equal to the purchase price of the non-complying Product; provided that in no event shall Omron be responsible for warranty, repair, indemnity or any other claims or expenses regarding the Products unless Omron's analysis confirms that the Products were properly handled, stored, installed and maintained and not subject to contamination, abuse, misuse or inappropriate modification. Return of any Products by Buyer must be approved in writing by Omron before shipment. Omron Companies shall not be liable for the suitability or unsuitability or the results from the use of Products in combination with any electrical or electronic components, circuits, system assemblies or any other materials or substances or environments. Any advice, recommendations or information given orally or in writing, are not to be construed as an amendment or addition to the above warranty.

See <https://www.omron.com/global/> or contact your Omron representative for published information.

Limitation on Liability; Etc

OMRON COMPANIES SHALL NOT BE LIABLE FOR SPECIAL, INDIRECT, INCIDENTAL, OR CONSEQUENTIAL DAMAGES, LOSS OF PROFITS OR PRODUCTION OR COMMERCIAL LOSS IN ANY

WAY CONNECTED WITH THE PRODUCTS, WHETHER SUCH CLAIM IS BASED IN CONTRACT, WARRANTY, NEGLIGENCE OR STRICT LIABILITY.

Further, in no event shall liability of Omron Companies exceed the individual price of the Product on which liability is asserted.

Application Considerations

Suitability of Use

Omron Companies shall not be responsible for conformity with any standards, codes or regulations which apply to the combination of the Product in the Buyer's application or use of the Product. At Buyer's request, Omron will provide applicable third party certification documents identifying ratings and limitations of use which apply to the Product. This information by itself is not sufficient for a complete determination of the suitability of the Product in combination with the end product, machine, system, or other application or use. Buyer shall be solely responsible for determining appropriateness of the particular Product with respect to Buyer's application, product or system. Buyer shall take application responsibility in all cases.

NEVER USE THE PRODUCT FOR AN APPLICATION INVOLVING SERIOUS RISK TO LIFE OR PROPERTY OR IN LARGE QUANTITIES WITHOUT ENSURING THAT THE SYSTEM AS A WHOLE HAS BEEN DESIGNED TO ADDRESS THE RISKS, AND THAT THE OMRON PRODUCT(S) IS PROPERLY RATED AND INSTALLED FOR THE INTENDED USE WITHIN THE OVERALL EQUIPMENT OR SYSTEM.

Programmable Products

Omron Companies shall not be responsible for the user's programming of a programmable Product, or any consequence thereof.

Disclaimers

Performance Data

Data presented in Omron Company websites, catalogs and other materials is provided as a guide for the user in determining suitability and does not constitute a warranty. It may represent the result of Omron's test conditions, and the user must correlate it to actual application requirements. Actual performance is subject to the Omron's Warranty and Limitations of Liability.

Change in Specifications

Product specifications and accessories may be changed at any time based on improvements and other reasons. It is our practice to change part numbers when published ratings or features are changed, or when significant construction changes are made. However, some specifications of the Product may

be changed without any notice. When in doubt, special part numbers may be assigned to fix or establish key specifications for your application. Please consult with your Omron's representative at any time to confirm actual specifications of purchased Product.

Errors and Omissions

Information presented by Omron Companies has been checked and is believed to be accurate; however, no responsibility is assumed for clerical, typographical or proofreading errors or omissions.

Statement of security responsibilities for assumed use cases and against threats

OMRON SHALL NOT BE RESPONSIBLE AND/OR LIABLE FOR ANY LOSS, DAMAGE, OR EXPENSES DIRECTLY OR INDIRECTLY RESULTING FROM THE INFECTION OF OMRON PRODUCTS, ANY SOFTWARE INSTALLED THEREON OR ANY COMPUTER EQUIPMENT, COMPUTER PROGRAMS, NETWORKS, DATABASES OR OTHER PROPRIETARY MATERIAL CONNECTED THERETO BY DISTRIBUTED DENIAL OF SERVICE ATTACK, COMPUTER VIRUSES, OTHER TECHNOLOGICALLY HARMFUL MATERIAL AND/OR UNAUTHORIZED ACCESS.

It shall be the users sole responsibility to determine and use adequate measures and checkpoints to satisfy the users particular requirements for (i) antivirus protection, (ii) data input and output, (iii) maintaining a means for reconstruction of lost data, (iv) preventing Omron Products and/or software installed thereon from being infected with computer viruses and (v) protecting Omron Products from unauthorized access.

Safety Precaution

Refer to the following manuals for safety precautions.

- *NX-series CPU Unit Hardware User's Manual (Cat. No. W535)*
- *NX-series NX502 CPU Unit Hardware User's Manual (Cat. No. W629)*
- *NX-series NX102 CPU Unit Hardware User's Manual (Cat. No. W593)*
- *NJ-series CPU Unit Hardware User's Manual (Cat. No. W500)*
- *Sysmac Studio Version 1 Operation Manual (Cat. No. W504)*

Precautions for Safe Use

This section describes the precautions for the safe use of the OPC UA Server.

- Even if you accidentally add the client certificate of a client for which you do not want to permit connection in the *Trusted Certificate List*, the OPC UA Server of the NJ/NX-series Controller will permit connections from that client.

As a result, confidential information on the server side may be leaked or unintended operation may be performed. Therefore, when you add a certificate to the *Trusted Certificate List* from the Sysmac Studio, make sure that all the certificates that you will register in the Trusted Certificate List are trusted client certificates.

- Even if a variable is set to Network Publish in the Sysmac Studio, the OPC UA client may not be able to refer to or read/write the variable in some cases depending on the limits set on variables that can be published to the OPC UA client of the OPC UA Server function.

Refer to the event log or Execution Log, and review the variables to be published to the network depending on the cause of occurrence. For details on the restrictions on variables that can be published in the OPC UA client, refer to *Restrictions on Publishing to the OPC UA Client* on page 6-12 in *6-2-2 Reading/Writing the Variables of the CPU Unit* on page 6-5.

Refer to the following manuals for other precautions for safe use that are not described above.

- *NX-series CPU Unit Hardware User's Manual (Cat. No. W535)*
- *NX-series NX502 CPU Unit Hardware User's Manual (Cat. No. W629)*
- *NX-series NX102 CPU Unit Hardware User's Manual (Cat. No. W593)*
- *NJ-series CPU Unit Hardware User's Manual (Cat. No. W500)*
- *Sysmac Studio Version 1 Operation Manual (Cat. No. W504)*

Precautions for Correct Use

This section describes the precautions for the correct use of the OPC UA Server.

- If the IP address of the built-in EtherNet/IP port is changed after starting the use of the OPC UA Server, the OPC UA server certificate in the CPU Unit will be disabled, and it will not be possible to communicate with the OPC UA client. In that case, manually regenerate the server certificate, or set the IP address back to the original address.
- The server certificate is not applied for backup and restore because it is information belonging to individual CPU Units. If you replace the CPU Unit hardware, you cannot use the same server certificate for the new CPU Unit after the replacement.
Even if you set the IP address of the built-in EtherNet IP port to the same value as the one for the previous CPU Unit, be sure to export the server certificate of the new CPU Unit and then perform installation again on the OPC UA clients.
- Even in cases where you recreate the server certificate by changing the IP address in the same CPU Unit, make sure to export the server certificate of the CPU Unit and install it at the OPC UA client side.
- The OPC UA Server is executed as a system service.
Accordingly, if other system services are executed while the OPC UA Server is starting up, they may take longer.
Moreover, if the system service execution time ratio is less (if it is below approx. 20%, as a reference), the response to the requests from the OPC UA client will be delayed. In such a case, design the task so that the system service execution time ratio increases.
- If you use the role function, check the operation for each role that you set for proper execution before you use it for actual operation. If it is incorrect, it may not be possible to change the variables related to the status of the devices, and it may be an unintended operation by the user.

Refer to the following manuals for other precautions for correct use that are not described above.

- *NX-series CPU Unit Hardware User's Manual (Cat. No. W535)*
- *NX-series NX502 CPU Unit Hardware User's Manual (Cat. No. W629)*
- *NX-series NX102 CPU Unit Hardware User's Manual (Cat. No. W593)*
- *NJ-series CPU Unit Hardware User's Manual (Cat. No. W500)*
- *Sysmac Studio Version 1 Operation Manual (Cat. No. W504)*

Regulations and Standards

Refer to the following manuals for regulations and standards.

- *NX-series CPU Unit Hardware User's Manual (Cat. No. W535)*
- *NX-series NX502 CPU Unit Hardware User's Manual (Cat. No. W629)*
- *NX-series NX102 CPU Unit Hardware User's Manual (Cat. No. W593)*
- *NJ-series CPU Unit Hardware User's Manual (Cat. No. W500)*

Software Licenses and Copyrights

This product incorporates the following third party software. The license and copyright information associated with this software is available at http://www.fa.omron.co.jp/nj_info_j/.

OpenSSL

This product includes software developed by the OpenSSL Project for use in the OpenSSL Toolkit (<http://www.openssl.org/>).

Copyright (C) 1998-2019 The OpenSSL Project. All rights reserved.

Copyright (C) 1995-1998 Eric Young (eay@cryptsoft.com). All rights reserved.

This product includes cryptographic software written by Eric Young (eay@cryptsoft.com).

This product includes software written by Tim Hudson (tjh@cryptsoft.com).

LibXML2

This product includes code that was developed for the XML toolkit from the GNOME project (<http://xmlsoft.org/>).

Copyright (C) 1998-2003 Daniel Veillard. All Rights Reserved.

OPC UA

This product includes code that was developed by Unified Automation GmbH for the OPC UA SDK (<http://www.unifiedautomation.com/>).

Copyright (C) 2008-2017 Unified Automation GmbH. All Rights Reserved.

The OPC UA SDK is based in part on <OPC UA Ansi C Stack> of the OPC Foundation.

Initial version of <OPC UA Ansi C Stack> was founded and copyrighted by OPC

Foundation, Inc. Copyright (C) 2008, 2014 OPC Foundation, Inc., All Rights Reserved.

Versions

Hardware revisions and unit versions are used to manage the hardware and software in the NJ/NX-series Units and EtherCAT slaves. The hardware revision or unit version is updated each time there is a change in hardware or software specifications. Even when two Units or EtherCAT slaves have the same model number, they will have functional or performance differences if they have different hardware revisions or unit versions.

Refer to the following manuals for versions.

- *NX-series CPU Unit Hardware User's Manual (Cat. No. W535)*
- *NX-series NX502 CPU Unit Hardware User's Manual (Cat. No. W629)*
- *NX-series NX102 CPU Unit Hardware User's Manual (Cat. No. W593)*
- *NJ-series CPU Unit Hardware User's Manual (Cat. No. W500)*

Unit Versions of CPU Units and the Sysmac Studio Versions

The functions that are supported depend on the unit version of the NJ/NX-series CPU Unit. The version of the Sysmac Studio that supports the functions that were added for an upgrade is also required to use those functions.

Refer to *A-6 Version Information* on page A-27 for the relationship between the unit versions of the CPU Units and the Sysmac Studio versions, and for the functions that are supported by each unit version.

Related Manuals

The followings are the manuals related to this manual. Use these manuals for reference.

Manual name	Cat. No.	Model numbers	Application	Description
NJ/NX-series CPU Unit OPC UA User's Manual	W588	NX701-□□□□ NX502-□□□□ NX102-□□□□ NJ501-1□00	Using the OPC UA.	Describes the OPC UA.
NJ/NX-series CPU Unit Built-in EtherNet/IP™ Port User's Manual	W506	NX701-□□□□ NX502-□□□□ NX102-□□□□ NX1P2-□□□□ NJ501-□□□□ NJ301-□□□□ NJ101-□□□□	Using the built-in EtherNet/IP port on an NJ/NX-series CPU Unit.	Information on the built-in EtherNet/IP port is provided. Information is provided on the basic setup, tag data links, and other features.
NX-series CPU Unit Hardware User's Manual	W535	NX701-□□□□	Learning the basic specifications of the NX701 CPU Units, including introductory information, designing, installation, and maintenance. Mainly hardware information is provided.	An introduction to the entire NX701 system is provided along with the following information on the CPU Unit. <ul style="list-style-type: none"> • Features and system configuration • Introduction • Part names and functions • General specifications • Installation and wiring • Maintenance and inspection
NX-series NX502 CPU Unit Hardware User's Manual	W629	NX502-□□□□	Learning the basic specifications of the NX502 CPU Units, including introductory information, designing, installation, and maintenance. Mainly hardware information is provided.	An introduction to the entire NX502 system is provided along with the following information on the CPU Unit. <ul style="list-style-type: none"> • Features and system configuration • Introduction • Part names and functions • General specifications • Installation and wiring • Maintenance and inspection
NJ-series CPU Unit Hardware User's Manual	W500	NJ501-□□□□ NJ301-□□□□ NJ101-□□□□	Learning the basic specifications of the NJ-series CPU Units, including introductory information, designing, installation, and maintenance. Mainly hardware information is provided.	An introduction to the entire NJ-series system is provided along with the following information on the CPU Unit. <ul style="list-style-type: none"> • Features and system configuration • Introduction • Part names and functions • General specifications • Installation and wiring • Maintenance and inspection
NX-series NX102 CPU Unit Hardware User's Manual	W593	NX102-□□□□	Learning the basic specifications of the NX102 CPU Units, including introductory information, designing, installation, and maintenance. Mainly hardware information is provided.	An introduction to the entire NX102 system is provided along with the following information on the CPU Unit. <ul style="list-style-type: none"> • Features and system configuration • Introduction • Part names and functions • General specifications • Installation and wiring • Maintenance and inspection

Manual name	Cat. No.	Model numbers	Application	Description
NJ/NX-series CPU Unit Software User's Manual	W501	NX701-□□□□ NX502-□□□□ NX102-□□□□ NX1P2-□□□□ NJ501-□□□□ NJ301-□□□□ NJ101-□□□□	Learning how to program and set up an NJ/NX-series CPU Unit. Mainly software information is provided.	The following information is provided on a Controller built with an NJ/NX-series CPU Unit. <ul style="list-style-type: none"> • CPU Unit operation • CPU Unit features • Initial settings • Programming based on IEC 61131-3 language specifications
NJ/NX-series Instructions Reference Manual	W502	NX701-□□□□ NX502-□□□□ NX102-□□□□ NX1P2-□□□□ NJ501-□□□□ NJ301-□□□□ NJ101-□□□□	Learning detailed specifications on the basic instructions of an NJ/NX-series CPU Unit.	The instructions in the instruction set (IEC 61131-3 specifications) are described.
NJ/NX-series Troubleshooting Manual	W503	NX701-□□□□ NX502-□□□□ NX102-□□□□ NX1P2-□□□□ NJ501-□□□□ NJ301-□□□□ NJ101-□□□□	Learning about the errors that may be detected in an NJ/NX-series Controller.	Concepts on managing errors that may be detected in an NJ/NX-series Controller and information on individual errors are described.
Sysmac Studio Version 1 Operation Manual	W504	SYSMAC -SE2□□□	Learning about the operating procedures and functions of the Sysmac Studio.	Describes the operating procedures of the Sysmac Studio.

Terminology

Term	Description
OPC UA	A protocol for communications between industrial devices that is independent of the manufacturer and platform, and is safe with a high reliability. It has an architecture in which the conventional OPC (Object Linking and Embedding for Process Control) has been generalized and widened in scope.
OPC UA Server	A communications service that provides the function of connecting to the OPC UA client in the NJ/NX-series. It is executed in a <i>system service</i> within the processing of the CPU Unit.
OPC UA server	Main entity of communications, such as an application, computer, or controller that supports the OPC UA, executes a service in response to a service request from the OPC UA client, and also sends a response.
OPC UA client	An application or computer that supports the OPC UA and issues a service request to the OPC UA server. Specifically, the main entity of communications, such as the SCADA and MES.
End point	The physical address that can be used on the OPC UA communications network used by the OPC UA client to access the OPC UA server. Specifically, the following address: <i>opc.tcp://[IPAddress]:[Port]</i> In the case of the OPC UA Server, the default address is: <i>opc.tcp://192.168.250.1:4840/</i>
Message	The data unit that expresses the requests or responses of the OPC UA server transmitted between the OPC UA client and the server.
Application authentication	The authentication of each other's identity by the server and the OPC UA client through the exchange of the mutual X.509 digital certificates during the establishment of a connection from the OPC UA client to the server.
User authentication	The authentication of the identity of the user operating the OPC UA client by the server during the establishment of a connection from the OPC UA client to the server.
Server certificate	An X.509 digital certificate that certifies the OPC UA server. It is generated and managed by the OPC UA server in combination with the private key of the certificate. In the NJ/NX-series, it indicates the self-certificate that certifies an individual CPU Unit as an OPC UA server. It is different for each serial number of the CPU Unit.
Client certificate	An X.509 digital certificate that certifies the OPC UA client. It is generated and managed by the OPC UA client in combination with the private key of the certificate. In the NJ/NX-series, it is necessary to register the client certificate in the CPU Unit by the Sysmac Studio.
Trusted certificate list	A list of certificates of the communications partner that must be trusted in application authentication. There are the following two types of trusted certificate lists at the server side and the OPC UA client side: <ul style="list-style-type: none"> Trusted certificate list at the server side: A list of client certificates that have been set to trust the OPC UA client. Trusted certificate list at the OPC UA client side: A list of server certificates that have been set to trust the server.
Rejected certificate list	A list of client certificates that have been rejected at the server side in application authentication.
Client authentication	Indicates the direct authentication of client certificates. <ul style="list-style-type: none"> Authentication of a self-signed client certificate is performed depending on whether it is present in the trusted certificate list. Authentication of a CA-signed client certificate is performed by checking the trust and revocation of the signed CA certificate.

Term	Description
Issuer authentication	Indicates the authentication by the certificate authority itself that has signed the client certificate. Authentication of a CA-signed client certificate is performed by checking the trust and revocation of the certificate of the certificate authority itself.
Certificate Authority	Organization that issues certificates.
OPC UA security profile	A common name for the client certificate, CA certificate, certificate revocation list, and security settings.
Security settings	A common name for user authentication settings, anonymous login, and security policy.
Security policy	A common name for the OPC UA security mode and OPC UA security policy.
OPC UA security mode	Setting the encryption and signature of messages in the security-related settings of messages in the OPC UA.
OPC UA security policy	Specification of algorithms such as signatures and encryption in the security-related settings of messages in the OPC UA.
Address space	A collection of information that visualizes the OPC UA server with respect to the OPC UA client. By referencing this information, the OPC UA client can use the objects of the OPC UA server and their related information.
Node	The basic component of the address space.
Event	A phenomenon that occurs in an unplanned and irregular manner in the NJ/NX-series Controllers.
Event log	A log for recognizing and recording the events that have occurred in the entire Controller. It is recorded in the CPU Unit. In the OPC UA Server, it indicates the errors and various states of the OPC UA Server.
Execution log	A log for recording the execution state of the OPC UA Server. It is saved in an SD Memory Card (sold separately). As compared to the event log, the execution log has a higher capacity and includes the access results from the OPC UA client to the variables. In view of future functional expansion, this Execution Log is considered as one of the types in the leading concept of the <i>Operation log</i> in the Sysmac Studio.
OPC UA instruction	Indicates instructions related to the OPC UA Server.

Revision History

A manual revision code appears as a suffix to the catalog number on the front and back covers of the manual.



Revision code	Date	Revised content
01	January 2018	Original production
02	April 2018	Made changes accompanying addition of NX102-□□□□.
03	July 2019	Corrected mistakes.
04	January 2021	Made changes accompanying addition of NX701-1□□□.
05	July 2021	Added information of the SD Memory Card.
06	April 2022	Added information of the function to expand nodes for structure members.
07	April 2022	Added information to Terms and Conditions Agreement.
08	November 2022	Changed character restrictions in client certificates.
09	April 2023	Made changes accompanying addition of NX502-1□□□.
10	April 2023	<ul style="list-style-type: none"> Added information on the functions supported by unit version 1.34 of the NX701-1□□□. Added information on the functions supported by unit version 1.62 of the NJ501-1□00.
11	October 2023	<ul style="list-style-type: none"> Added information on the functions supported by unit version 1.64 of the NX502-1□00. Added information on the functions supported by unit version 1.64 of NX102-□□□□.

1

Overview of OPC UA Server Function

This section describes an overview of the OPC UA Server function.

1-1	Overview and Features	1-2
1-1-1	Overview	1-2
1-1-2	System Configuration	1-2
1-1-3	Features	1-2
1-2	Specifications	1-4
1-2-1	List of Supported CPU Units	1-4
1-2-2	Function Specifications	1-4
1-3	OPC UA Server Procedures	1-8
1-3-1	Overall Procedure	1-8
1-3-2	Procedure Details	1-9

1-1 Overview and Features

This section describes an overview and features of the OPC UA Server function.

1-1-1 Overview

The OPC UA Server function enables the NJ/NX-series CPU Unit to operate as an *OPC UA server*. With this function, OPC UA clients can connect via Ethernet to the built-in EtherNet/IP port of the NJ/NX-series CPU Unit using the OPC UA communications, and then read and write variables in the CPU Unit.

The OPC UA communications can simultaneously achieve both addressing security risks and connecting with general-purpose methods. Therefore, the OPC UA Server function enables secure data exchanges between the CPU Unit and host systems such as SCADA or MES compatible OPC UA so that the host systems can collect manufacturing progress information or issue manufacturing instructions.

1-1-2 System Configuration

The OPC UA Server function supports the following system configuration.

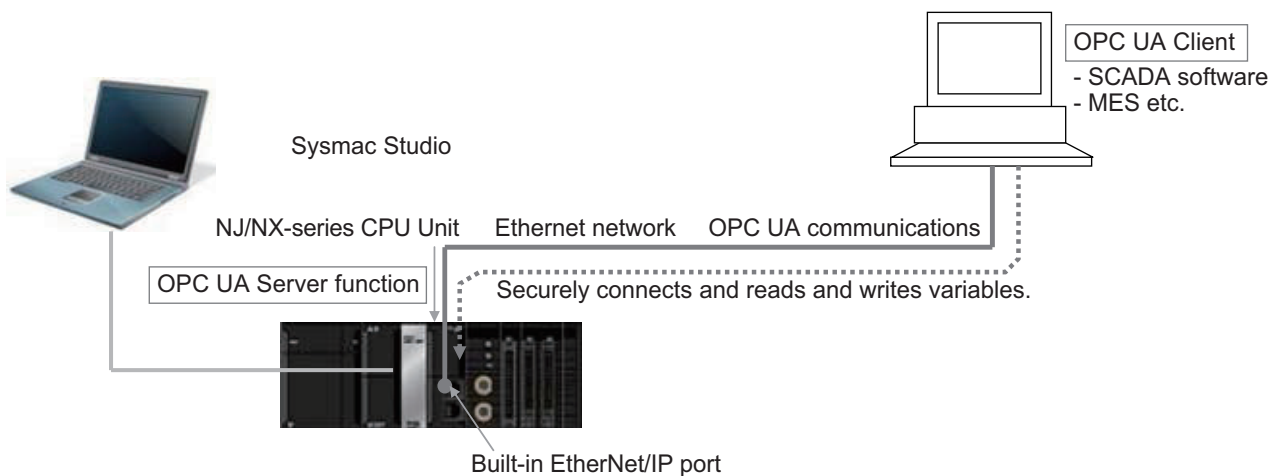

Refer to *A-6 Version Information* on page A-27 for the unit version of the CPU Unit and the version of the Sysmac Studio that can be supported.

1-1-3 Features

The OPC UA Server function has the following features.

Supporting OPC UA Communications as Secure Industrial Standard Communications

OPC UA communications have the following features.

- A versatile global standard network from discrete control to process control, and from the sensor or controller level to the host monitoring and management level.

- Also defined as a recommended communications standard of Industrie 4.0 to connect the control networks in factories to the IT networks.
- Allows full-scale secure information exchange in the industrial system consisting of different devices.
- Allows to expand the visualization of information adapting to the system in the object-based Address Space.

Providing the Server Function of OPC UA Communications in the NJ/NX-series Controller

1

The NJ/NX-series OPC UA Server function has the following features.

- It allows the Controller to connect directly to the OPC UA client via Ethernet without relaying the computer.
- Since the NJ/NX-series CPU Unit has EtherCAT communications as the lower level network, it makes it easy to gather sensor and actuator level information on EtherCAT into OPC UA communications as a higher network.
- You can check the operation results of the OPC UA Server function from the event log in the Controller and the Execution Log.

1-2 Specifications

This section describes the specifications of the OPC UA Server function.

1-2-1 List of Supported CPU Units

The OPC UA Server is supported by the following CPU Unit models.

CPU Unit model	Unit version
NX701-1600	Ver.1.24 or later
NX701-1700	
NX701-1620	
NX701-1720	
NX502-1500	Ver.1.60 or later
NX502-1400	
NX502-1300	
NJ501-1300	Ver.1.17 or later
NJ501-1400	
NJ501-1500	
NX102-9000	Ver.1.30 or later
NX102-1000	
NX102-1100	
NX102-1200	
NX102-9020	
NX102-1020	
NX102-1120	
NX102-1220	

1-2-2 Function Specifications

Specifications of the OPC UA Server

Item	NJ501-1□□□	NX502-1□□□	NX701-1□□□	NX102-□□□□
Connection ports	Built-in EtherNet/IP port on the CPU Unit	Built-in EtherNet/IP port (port 1) on the CPU Unit		
	Note The OPC UA Server function can be used simultaneously with EtherNet/IP communications.			
OPC UA function	Server function			
Transport and data encoding	UA TCP binary			
Support profile and model	Embedded 2017 UA Server Profile PLCopen Information Model 1.00			
Endpoint URL (server URL)	opc.tcp://[IP address]: [port No.]/ By default, the following URL is used. opc.tcp://192.168.250.1:4840/			
Maximum number of sessions (user)	5			
Maximum number of monitor items for the entire server	2,000		20,000*2	2,000

Item		NJ501-1□□00	NX502-1□□00	NX701-1□□□□	NX102-□□□□□
Maximum number of subscriptions for the entire server		100			
Variable type		Network variable			
Conditions across network-published variables*1	Maximum number of variables that can be published	10,000		100,000*3	10,000
	Maximum number of value attributes for a variable that can be published	No restriction*4			
	Number of structure definitions that can be published	100			
Conditions that cannot be published for each network-published variable		<p>Refer to <i>Restrictions on Publishing to the OPC UA Client</i> on page 6-12 for details.</p> <p>In the following cases, structures, arrays, and entire variables cannot be published.</p> <ul style="list-style-type: none"> Structures <ul style="list-style-type: none"> A multidimensional array is specified*5*6 Containing a multidimensional array as a member*6 Containing a multidimensional array specified structure as a member*7 Containing two-dimensional or higher structure arrays for global variables and two-dimensional or higher arrays Nesting number exceeds three levels*8 The number of members exceeds 100 Containing a union as a structure member Arrays <ul style="list-style-type: none"> Containing a variable whose starting number is not 0; e.g., Array [2.. 5] The number of elements exceeds 2,048*9*10 Entire variables <ul style="list-style-type: none"> A variable whose size exceeds 60 KB*11*12 Global variables, program names, and user-defined data type names with reserved words for node names that cannot be published in the OPC UA address space Unions 			
OPC UA Security Mode and Policy		<p>Allowable security methods can be specified from the following (multiple specifications possible)*13</p> <ul style="list-style-type: none"> Both signature and encryption required: SignAndEncrypt Signature and encryption algorithm: Aes256Sha256PsaPss/Aes128Sha256RsaOaep/Basic256Sha256/Basic256/Basic128Rsa15 (multiple specifications possible) Only signature required: Sign Signature algorithm: Aes256Sha256PsaPss/Aes128Sha256RsaOaep/Basic256Sha256/Basic256/Basic128Rsa15 (multiple specifications possible) Neither signature nor encryption required 			
Application Authentication	Authentication	X.509			
	Number of certificates that can be stored	<ul style="list-style-type: none"> Trusted certificates: 32 CA certificates: 32 Rejected certificates: 32 			

Item		NJ501-1□□00	NX502-1□□00	NX701-1□□□□	NX102-□□□□□
User Au- thentication	Method of user au- thentication	The following can be set: <ul style="list-style-type: none"> • User name/Password/Role*¹⁴ • Anonymous 			

- *1. Refer to *Restrictions on Publishing to the OPC UA Client* on page 6-12 for details.
- *2. For the unit versions of the following CPU Units, the maximum number is 2,000.
NX701-1 □□□: Version earlier than 1.34
- *3. For the unit versions of the following CPU Units, the maximum number is 10,000.
NX701-1 □□□: Version earlier than 1.34
- *4. For the unit versions of the following CPU Units, the maximum value is 10,000.
NJ501-1□□00: Version earlier than 1.62
NX102-□□□□□: Version earlier than 1.63
NX502-1□□00: Version earlier than 1.63
NX701-1 □□□: Version earlier than 1.34
- *5. The *multidimensional array specified structure* indicates two-dimensional or higher array specifications in which the elements are structures.
- *6. The condition is applied for the unit versions of the following CPU Units.
NJ501-1□□00: Version earlier than 1.62
NX102-□□□□□: Version earlier than 1.63
NX502-1□□00: Version earlier than 1.63
NX701-1□□□: Version earlier than 1.34
- *7. The *structure containing a multidimensional array specified structure as a member* indicates a structure type containing two or higher dimensional structure array specifications as a member.
- *8. Refer to *Nesting Levels* in the *NJ/NX-series CPU Unit Software User's Manual (Cat. No. W501)* for levels.
- *9. For the unit versions of the following CPU Units, the maximum value is 1,024.
NJ501-1□□00: Version earlier than 1.48
NX102-□□□□□: Version earlier than 1.48
NX701-1□□□: Version earlier than 1.28
- *10. It is applied in the following cases.
 - For the unit versions of the following CPU Units
NJ501-1□□00: Version earlier than 1.62
NX102-□□□□□: Version earlier than 1.63
NX502-1□□00: Version earlier than 1.63
NX701-1□□□: Version earlier than 1.34
 - For the unit versions of the following CPU Units and for global variables
NJ501-1□□00: Version 1.62 or later
NX102-□□□□□: Version 1.64 or later
NX502-1□□00: Version 1.64 or later
NX701-1□□□: Version 1.34 or later
- *11. The total request/reply size of one message by the OPC UA service must be 60 KB or less, even when handling multiple variables.
- *12. For the unit versions of the following CPU Units, the maximum value is 1,024 bytes.
NJ501-1□□00: Version earlier than 1.48
NX102-□□□□□: Version earlier than 1.48
NX701-1 □□□: Version earlier than 1.28
- *13. There are precautions for security. Refer to *5-2-2 OPC UA Security Mode and Policy* on page 5-9 for details.
- *14. Roles can be set for the unit versions of the following CPU Units.
NJ501-1□□00: Version 1.62 or later
NX102-□□□□□: Version 1.64 or later
NX502-1□□00: Version 1.64 or later
NX701-1□□□: Version 1.34 or later



Precautions for Correct Use

For the NX701-1□□□ CPU Unit, NX502-1□□0 CPU Unit, and NX102-□□□□ CPU Unit, there are two built-in EtherNet/IP ports, PORT 1 and PORT 2. Note that only PORT 1 is the port that supports the OPC UA Server.

1-3 OPC UA Server Procedures

This section describes the OPC UA Server Procedures.

1-3-1 Overall Procedure

The overall procedure for using the OPC UA Server is as follows. For details, refer to *1-3-2 Procedure Details* on page 1-9.

	Step	Description	Reference
STEP 1. Settings	1-1. IP address setting of the built-in EtherNet/IP port		<i>Section 3 Settings of the OPC UA Server</i> on page 3-1
	1-2. OPC UA Settings (offline)	<ul style="list-style-type: none"> Offline: Whether OPC UA server is used or not 	
	1-3. Settings for publishing variables to the OPC UA client	<ul style="list-style-type: none"> Public settings of variables 	
	1-4. Downloading (synchronization)		
	(When using for the first time) 1-5. Cycling the power supply to the Controller (or re-setting the Controller)		
	1-6. Confirming the start of OPC UA Server function (online)		
	1-7. OPC UA Settings (online)	<ul style="list-style-type: none"> Online: server certificate, client certificates, security settings 	



STEP 2. Operation	2-1. Connecting from an OPC UA client		<i>Section 6 Connecting from the OPC UA Client and Reading/Writing Variables</i> on page 6-1
	2-2. Checking communications from the OPC UA Client	<ul style="list-style-type: none"> Refer to the address space of the OPC UA Server function from the OPC UA client Design the variable designation 	
	2-3. Reading and writing variable from the OPC UA client		



STEP 3. Shut-down	3-1. Stopping the Controller	<ul style="list-style-type: none"> • Disconnect from the client • Shut down the OPC UA Server function. • Turn OFF the power supply to the Controller. 	4-2-1 <i>Checking Based on OPC UA Server Status of the Sysmac Studio</i> on page 4-5
--------------------------	------------------------------	---	--



STEP 4. Troubleshooting	4-1. Client error check		
	4-2. Status Monitor	<ul style="list-style-type: none"> • Check the operating status of the OPC UA Server function, etc. 	4-2-1 <i>Checking Based on OPC UA Server Status of the Sysmac Studio</i> on page 4-5
	4-3. Checking the event log	<ul style="list-style-type: none"> • Check the status log 	<i>Section 9 Troubleshooting</i> on page 9-1

1-3-2 Procedure Details

The procedure for using the OPC UA Server is shown separately for the OPC UA Server side and the OPC UA client side as follows.

Step	OPC UA Server	OPC UA client*1	Reference
STEP 1. Settings	1-1. IP address setting of the built-in EtherNet/IP port		3-1-1 <i>IP Address Settings of the Built-in EtherNet/IP Port</i> on page 3-2
	1-2. OPC UA Settings (off-line)	<ul style="list-style-type: none"> • Create client certificates • Other settings of OPC UA client side 	3-2-2 <i>OPC UA Server Settings</i> on page 3-5
	1-3. Settings for publishing variables to the OPC UA client	In the Global Variable Editor of the Sysmac Studio, register the global variables for OPC UA communications with <i>Network Publish Attribute</i> set to <i>Publish Only, Input, or Output</i> . Or register in Server Settings.	

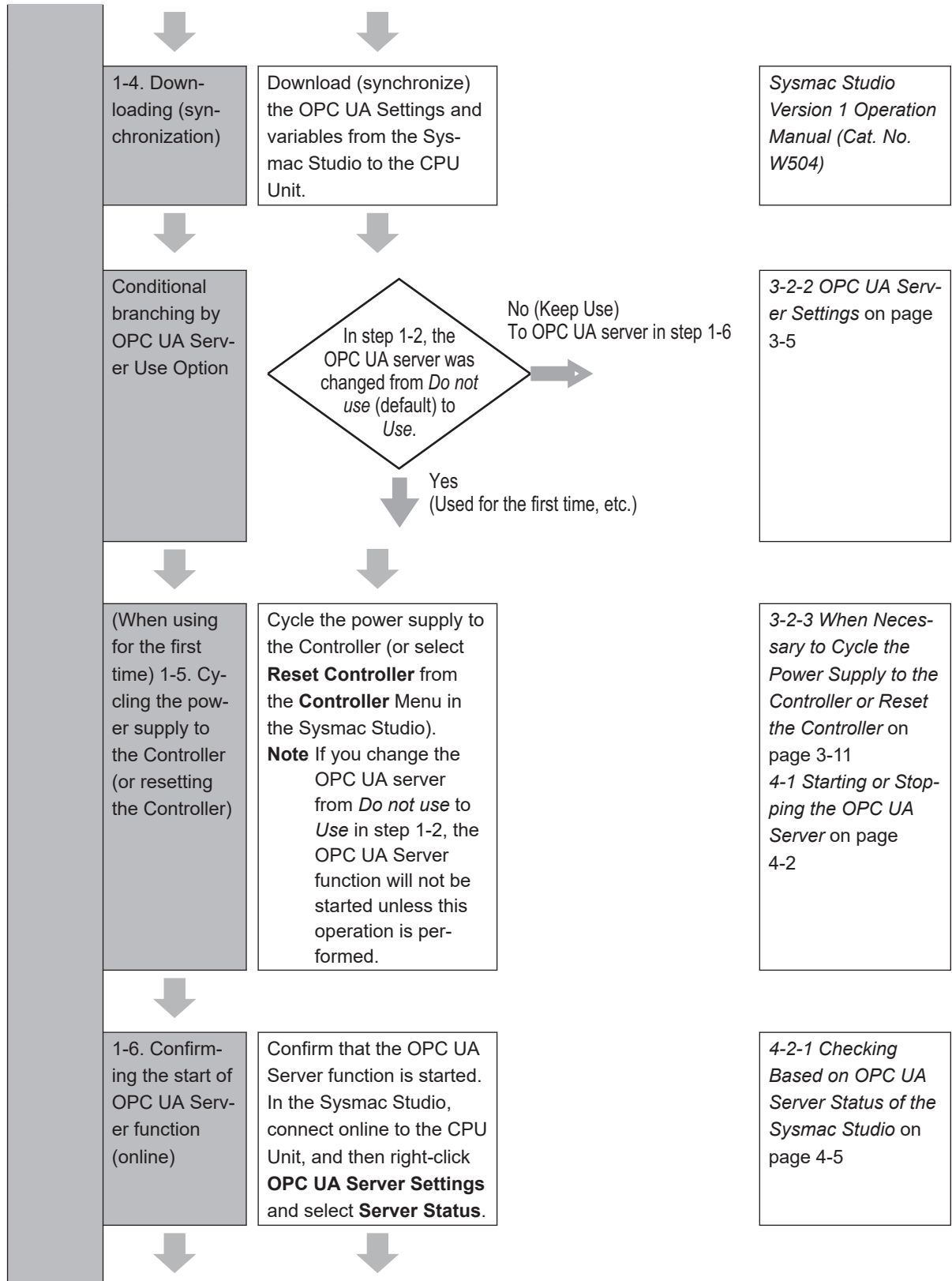

1-7. OPC UA Settings (online)	Use the following procedure from Configurations and Setup – OPC UA Settings in the Sysmac Studio.	<i>Section 5 Security Function of OPC UA Server</i> on page 5-1
	Server certificate operations: Right-click OPC UA Server Settings and select Server Certificate . Click the Regenerate certificate Button to set the detailed information of the server certificate and perform the regenerate operation of the server certificate*2*3.	<i>Regenerating the Server Certificate</i> on page 3-15
	Export the server certificate.	<i>Exporting Server Certificate</i> on page 3-15
	Client certificates operations: Right-click OPC UA Server Settings and select Client Authentication . <ul style="list-style-type: none"> • Operations such as adding the client certificates created on the client side in step 1-2. 	<i>Client Authentication</i> on page 3-17
	Security Settings operations: Right-click OPC UA Server Settings and select Security Settings . <ul style="list-style-type: none"> • User Authentication Settings • Anonymous login Security Policy 	<i>3-2-6 Security Settings</i> on page 3-24
	Note In order to support the CA-signed client certificates, the CA certificate and certificate revocation list must be registered.	<i>A-3 When CA-signed Client Certificates Supported</i> on page A-14



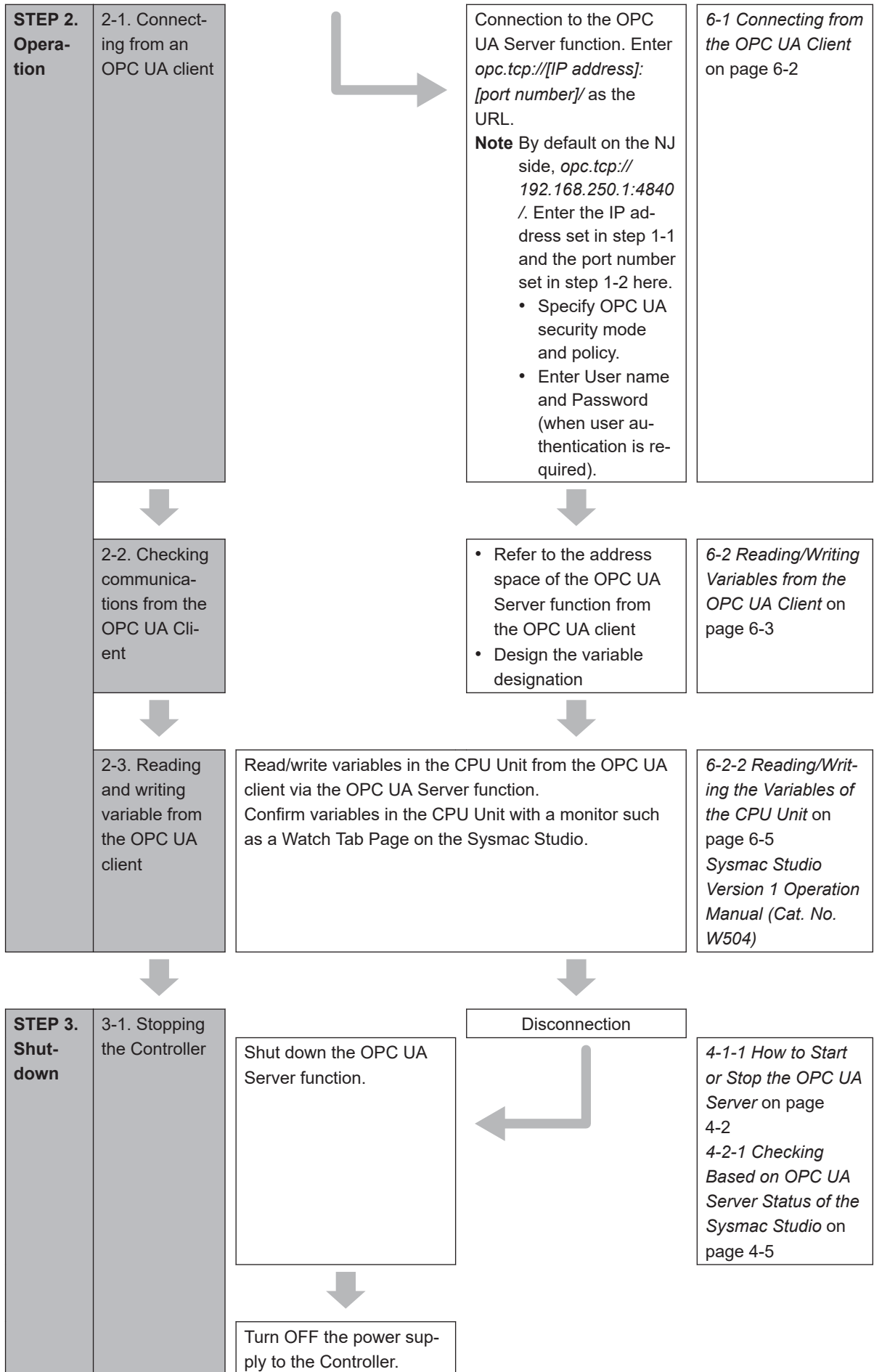

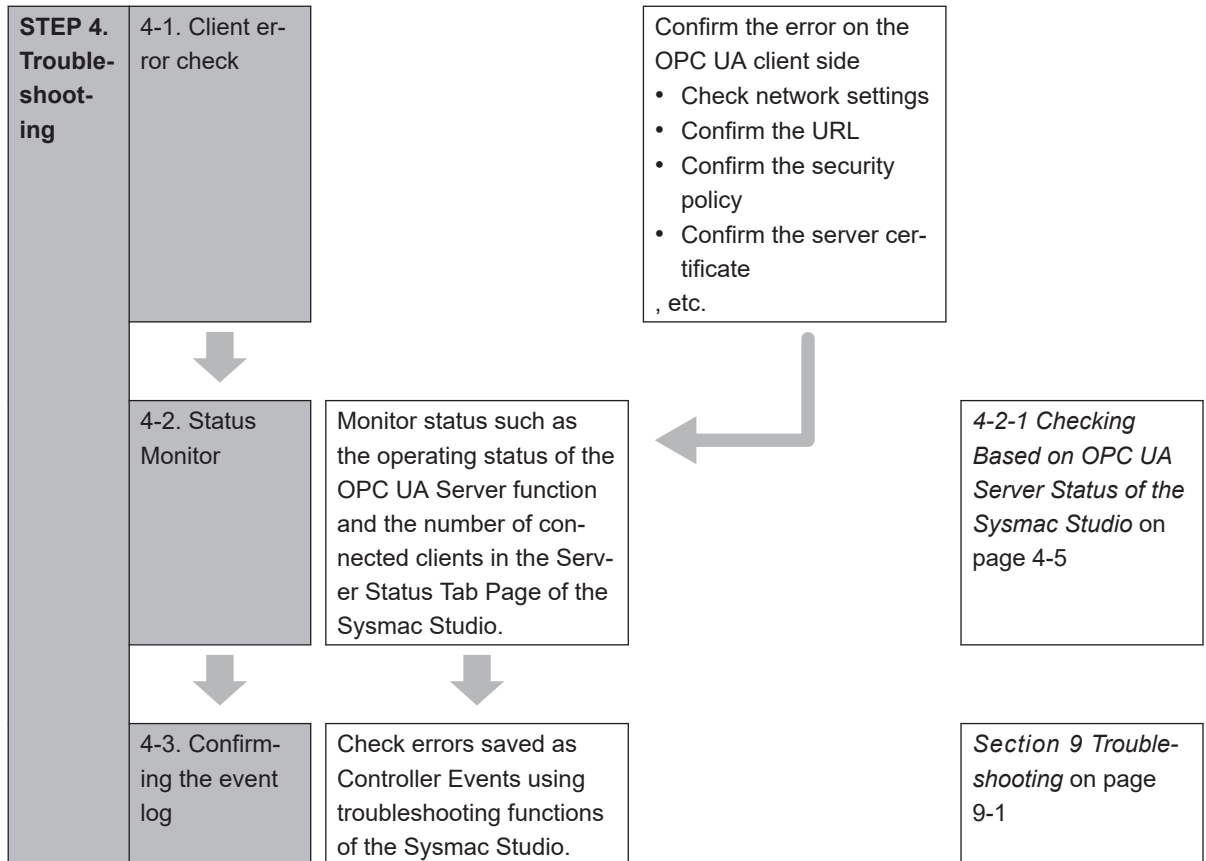

- *1. For operation of the OPC UA client, refer to the manual of each OPC UA client.
- *2. The server certificate is generated with the IP address that is set.
After that, when you change the IP address by setting operation or instruction execution, be sure to regenerate the server certificate. If the server certificate is not regenerated, the IP address of the built-in EtherNet/IP port will not match the IP address of the server certificate. In that case, note that the OPC UA client cannot connect to the OPC UA Server function.
- *3. If the OPC UA Server remains *Use* before and after the downloading (synchronization function) in step 1-4, this operation of regenerating the server certificate is not necessary.

2

Structure of the OPC UA Server

This section describes the structure of the OPC UA Server.

2-1	Internal Structure of the Overall OPC UA Communications System	2-2
2-1-1	Overview	2-2
2-1-2	Details	2-2
2-2	Overview of the Security Function of the OPC UA Server	2-5

2-1 Internal Structure of the Overall OPC UA Communications System

This section describes the internal structure of the overall OPC UA communications system with the NJ/NX-series CPU Unit as an OPC UA server.

2-1-1 Overview

An overview of the overall OPC UA communications system is provided below.

The description is given separately for the NJ/NX-series CPU Unit side as a server and the OPC UA client side.

OPC UA Server Side (CPU Unit Side)

- Set in advance the parameters for communications with the OPC UA client to the CPU Unit from the Sysmac Studio. There are settings that can be done offline and ones that are only available online.
- Start a communications service that is called *OPC UA Server* and execute the OPC UA communications.

OPC UA Client Side

- Connect from the OPC UA client to the CPU Unit as a server.
- From the OPC UA client, read and write variables in the CPU Unit as a server.

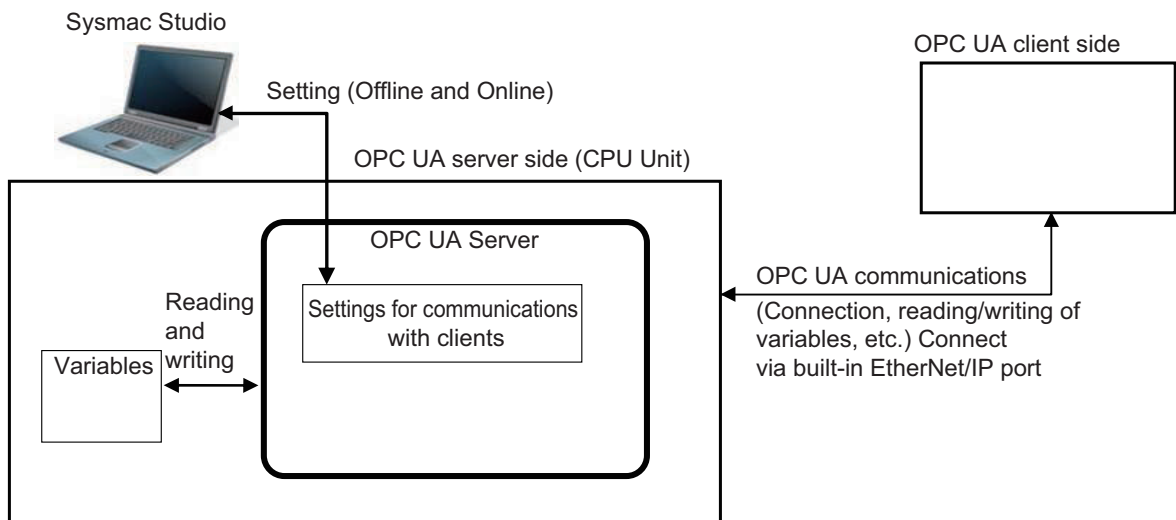

2-1-2 Details

The details of the structure of the overall OPC UA communications system are described by using the following figure.

Note that the (Figure a) to (Figure e) in the table shown below correspond to the (a) to (e) in the following figure.

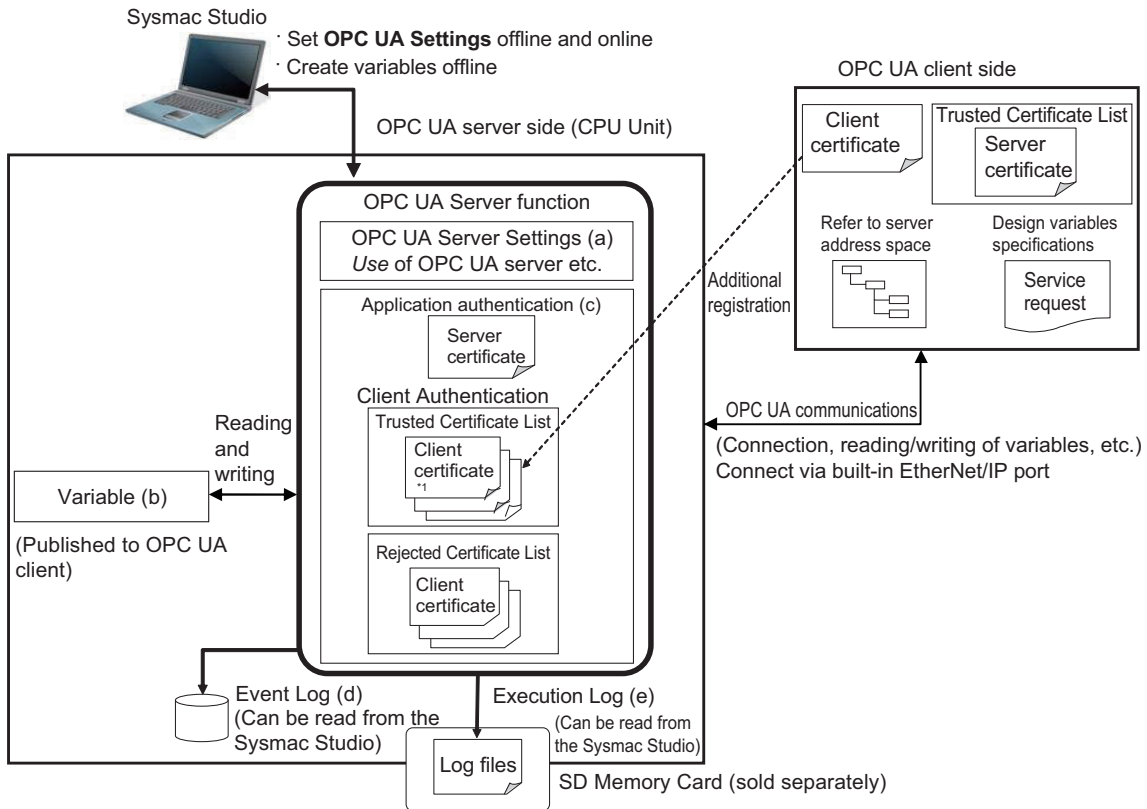

Note The above figure shows the case of a self-signed client certificate. You can also support a CA-signed client certificate. To use the CA-signed client certificate, refer to A-3 When CA-signed Client Certificates Supported on page A-14.

Basic Mechanism

The basic mechanism from the start for using the OPC UA Server to reading and writing variables is as follows. The basic mechanism is shown in accordance with the usage procedure.

Basic mechanism (the number indicates the order of procedure)	Reference
1. In the Sysmac Studio, set OPC UA Server Settings from Configurations and Setup - OPC UA Settings in Multiview Explorer by an offline operation (Figure a).	3-1 <i>Controller Setup</i> on page 3-2 3-2-2 <i>OPC UA Server Settings</i> on page 3-5
2. Create variables to be published for OPC UA communications (Figure b).	3-3 <i>Creating Variables for OPC UA Communications</i> on page 3-33
3. Transfer OPC UA server settings and variables to the CPU Unit using synchronization function from the Sysmac Studio.	<i>Sysmac Studio Version 1 Operation Manual (Cat. No. W504)</i>
4. In the Sysmac Studio, connect online to the CPU Unit, and perform operations of the application authentications and security settings (Figure c).	<i>Sysmac Studio Version 1 Operation Manual (Cat. No. W504)</i> 3-2-5 <i>Setting and Displaying the Certificate</i> on page 3-12 3-2-6 <i>Security Settings</i> on page 3-24

Basic mechanism (the number indicates the order of procedure)	Reference
5. Turn ON the power supply to the Controller and start using the OPC UA Server function. Note The OPC UA server in OPC UA Server Settings must be set to <i>Use</i> .	4-1 <i>Starting or Stopping the OPC UA Server</i> on page 4-2
6. Connect from the OPC UA client to the OPC UA Server function. Connect to the server by specifying <i>opc.tcp://[IP address]:[port No.]</i> as the URL. Enter the User name/Password from the OPC UA client.	6-1 <i>Connecting from the OPC UA Client</i> on page 6-2
7. Read and write from the OPC UA client From the OPC UA client, refer to the address space of the OPC UA Server function and design variables specifications. Request service from the OPC UA client, read and write variables of the CPU Unit published to OPC UA communications.	6-2 <i>Reading/Writing Variables from the OPC UA Client</i> on page 6-3

Status Confirmation

The following table shows how to confirm the status of the OPC UA Server.

Means of confirmation	Status confirmation mechanism	Reference
OPC UA server status	The server operating status and the number of currently connected OPC UA clients can be checked with the OPC UA server status in the Sysmac Studio.	4-2 <i>Checking the Status of the OPC UA Server</i> on page 4-5
Event Log	Failure of OPC UA Server and status are stored as event logs (Figure d) of the NJ/NX-series Controllers. You can confirm with troubleshooting functions of the Sysmac Studio.	Section 9 <i>Troubleshooting</i> on page 9-1
Execution Log	Logs (Figure e) for recording the execution status of the OPC UA Server, variable published-status, authentication processing, and operation of certificates are saved as a log file in the SD Memory Card (sold separately) in the CPU Unit. You can confirm in Operation Logs Display on the Sysmac Studio.	Section 7 <i>Execution Log Functions</i> on page 7-1

2-2 Overview of the Security Function of the OPC UA Server

This section describes the overview of the security function of the OPC UA Server.

The OPC UA Server of the NJ/NX-series CPU Unit supports the server function of the OPC UA. There are the following two security functions as a server in the OPC UA Server.

Function	Description
Connection authentication function of the OPC UA Server	The OPC UA Server permits connections from only authenticated OPC UA clients and users.
Message security function	Upon receiving requests from OPC UA clients and sending responses to OPC UA clients, the OPC UA Server signs and encrypts the messages.

Set the following contents, in advance, to use the security functions as a server.

Function	Setting	Reference
Connection authentication function of the OPC UA Server	Certificate settings <ul style="list-style-type: none"> Regeneration of the server certificate (only when necessary) Self-signed client certificates: Additional registration of client certificates, and trust or reject settings of each client complete certificates at client authentication CA-signed client certificates: Additional registration of CA certificates and certificate revocation list at client authentication and issuer authentication 	3-2-5 <i>Setting and Displaying the Certificate</i> on page 3-12
	User Authentication Settings <ul style="list-style-type: none"> User name, Password, and Role to authenticate *1 Prohibition or permission for anonymous login 	3-2-6 <i>Security Settings</i> on page 3-24
Message security function	OPC UA security mode and policy that are allowed for the OPC UA client as a server	3-2-6 <i>Security Settings</i> on page 3-24

*1. Roles can be set for the unit versions of the following CPU Units.

- NJ501-1□□00: Version 1.62 or later
- NX102-□□□□: Version 1.64 or later
- NX502-1□□00: Version 1.64 or later
- NX701-1□□□: Version 1.34 or later

For details on the security functions, refer to *Section 5 Security Function of OPC UA Server* on page 5-1.

3

Settings of the OPC UA Server

This section describes the settings required to use the OPC UA Server.

3-1	Controller Setup	3-2
3-1-1	IP Address Settings of the Built-in EtherNet/IP Port.....	3-2
3-2	OPC UA Settings	3-3
3-2-1	Overview of OPC UA Settings.....	3-3
3-2-2	OPC UA Server Settings	3-5
3-2-3	When Necessary to Cycle the Power Supply to the Controller or Re-set the Controller	3-11
3-2-4	Automatic Generation of the Server Certificate.....	3-12
3-2-5	Setting and Displaying the Certificate	3-12
3-2-6	Security Settings	3-24
3-2-7	Server Status.....	3-31
3-2-8	Displaying the Operation Logs	3-31
3-2-9	Operations for the OPC UA Settings.....	3-32
3-3	Creating Variables for OPC UA Communications	3-33
3-3-1	Global Variables Published to OPC UA Communications.....	3-33
3-3-2	Variables in User-defined Function Blocks Published to OPC UA Communications.....	3-34
3-3-3	Variables Based on Companion Specifications Published to OPC UA Communications.....	3-36
3-3-4	Differences in Method to Publish Variables between User-defined and Companion Specifications.....	3-38
3-3-5	Adding or Deleting Network-published Variables	3-39

3-1 Controller Setup

This section describes the following Controller Setup related to the OPC UA function.

- Setting the IP address of the built-in EtherNet/IP port

For general settings of the built-in EtherNet/IP port, refer to the *NJ/NX-series CPU Unit Built-in EtherNet/IP Port User's Manual (Cat. No. W506)*.

For details on the operation, refer to the *Sysmac Studio Version 1 Operation Manual (Cat. No. W504)*.

3-1-1 IP Address Settings of the Built-in EtherNet/IP Port

Select one of the following settings in the *IP address* of **TCP/IP Settings** in **Configurations and Setup - Controller Setup - Built-in EtherNet/IP Port Settings** in the Multiview Explorer in the Sysmac Studio:

Fixed Setting, or *Fix at the IP address obtained from BOOTP server*

For details on the settings, refer to the *NJ/NX-series CPU Unit Built-in EtherNet/IP Port User's Manual (Cat. No. W506)*.

The server certificate is automatically or manually generated with the IP address that is set in the Controller Setup. For information on automatic generation of server certificates, refer to *3-2-4 Automatic Generation of the Server Certificate* on page 3-12. For information on the manual regeneration of server certificates, refer to *3-2-5 Setting and Displaying the Certificate* on page 3-12 in *Regenerating the Server Certificate* on page 3-15.



Precautions for Correct Use

- If you change the IP address by downloading the settings or executing the instruction after the server certificate is generated automatically or manually, the IP address of the built-in EtherNet/IP port will not match that of the Server certificate. As a result, the OPC UA client cannot connect to the OPC UA Server. Then, a *Server Certificate Mismatch* event (event code: 15020000 hex) occurs. In this case, manually regenerate the server certificate or set the IP address back to the original address.
- Dynamic IP address setting by DHCP is not recommended when using the OPC UA function. If the OPC UA function is used, the user needs to update the server certificate and reconnect the client each time the IP address is changed.
When the IP address of the device is changed by the DHCP function, a mismatch with the IP address of the server certificate is registered in the event log and recorded in the execution log.

3-2 OPC UA Settings

You must set the OPC UA Settings before the OPC UA Server runs.
This section describes how to set the OPC UA Settings.

3-2-1 Overview of OPC UA Settings

The following is an overview of the OPC UA Settings.

The OPC UA Settings are located in **Configurations and Setup** in Multiview Explorer in the Sysmac Studio as follows.

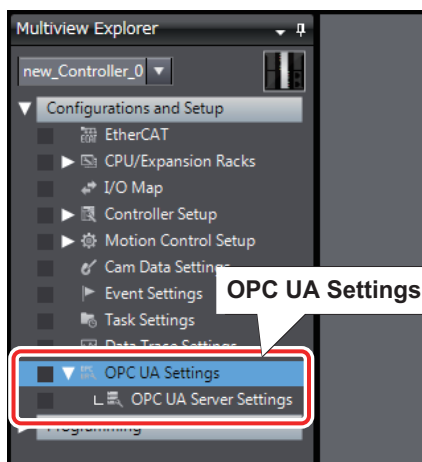

There are three types of **OPC UA Settings**; items that are recorded in the project file in the Sysmac Studio, items that are not recorded in the project file in the Sysmac Studio and required to be set for each CPU Unit, and items that are only displayed or operated without any setting. The differences of each are described in the table below.

Item	Description	Backup
Items that are recorded in the project file	The settings are recorded in the project file in the Sysmac Studio. Download the project file to the CPU Unit after setting on the Sysmac Studio.	Applicable
Items that are not recorded in the project file and required to be set for each CPU Unit	The settings are not recorded in the project file in the Sysmac Studio. You must make the settings online for each CPU Unit.	Applicable
Items that are only displayed or operated	There is no setting to make, the data in the CPU Unit is only displayed or operated.	Not applicable

Items That Are Recorded in the Project File

The following table gives the the items that are recorded in the project file.

Items of OPC UA Settings	Contents	Procedure	Reference
OPC UA Server Settings	Set the following items in the OPC UA Server Settings Tab Page.	Double-click OPC UA Server Settings or right-click it and select Edit from menu	3-2-2 <i>OPC UA Server Settings</i> on page 3-5
	<ul style="list-style-type: none"> • Use of the OPC UA Server: Set whether to use. 		
	<ul style="list-style-type: none"> • End Point Settings: Display the End point and set the port number. 		
	<ul style="list-style-type: none"> • Execution Log Settings: Set whether to record, set the number of log files, and set the number of records. 		

Items That Are Not Recorded in the Project File

The following table gives the items that are not recorded in the project file and required to be set for each CPU Unit.

For some of these items, there are restrictions on the operation authority from the Sysmac Studio. For details on the operation authority of the OPC UA Server in the Sysmac Studio, refer to *8-1 The Sysmac Studio Operation Authority Verification Related to the OPC UA Server* on page 8-2.

Items of OPC UA Settings	Contents	Procedure	Reference
Server Certificate	Display and operate the server certificate in the Server Certificate Tab Page.	Right-click OPC UA Server Settings and select from the menu.	3-2-3 <i>When Necessary to Cycle the Power Supply to the Controller or Reset the Controller</i> on page 3-11
Client Authentication	<ul style="list-style-type: none"> • For a self-signed client certificate: Display and operate the Trusted Certificate List and the Client Rejected Certificate List in the Client Authentication Tab Page. 		
	<ul style="list-style-type: none"> • For a CA-signed client certificate: Display and operate the Trusted Certificate List of the CA certificate that is signed and the Certificate Revocation List in the Client Authentication Tab Page. 		
Issuer Authentication	For a CA-signed client certificate only: Display and operate the Trust List of the CA's own Certificate and the Certificate Revocation List in the Issuer Authentication Tab Page.		<i>Issuer Authentication</i> on page A-17
Security Settings	The following settings are made in the Security Setting Tab Page. <ul style="list-style-type: none"> • User name, Password, and Role to authenticate*1 • Prohibition or permission for anonymous login • Security mode policy 		3-2-6 <i>Security Settings</i> on page 3-24

*1. Roles can be set for the unit versions of the following CPU Units.

NJ501-1□□00: Version 1.62 or later
 NX102-□□□□: Version 1.64 or later
 NX502-1□□00: Version 1.64 or later
 NX701-1□□□: Version 1.34 or later

Items That Are Only Displayed or Operated

The following table gives the items that are only displayed or operated.

Items of OPC UA Settings	Contents	Procedure	Reference
Server Status	Display the operating status of the OPC UA Server and shutdown the OPC UA Server in the Server Status Tab Page.	Right-click OPC UA Server Settings and select from the menu.	4-2-1 <i>Checking Based on OPC UA Server Status of the Sysmac Studio</i> on page 4-5
Operation Log Display	List and operate the Execution Logs in the Show Operation Log Tab Page.	Right-click OPC UA Settings and select from the menu.	7-2 <i>Checking the Execution Log</i> on page 7-15

3-2-2 OPC UA Server Settings

The following shows how to make the *OPC UA Server Settings* and its contents.

The OPC UA Server Settings consist of the following.

- OPC UA Server Use Option setting
- End Point Settings
- Execution Log Settings
- Node Setting
- Network Publishing Settings



Additional Information

When you click the **Reset all to default**. Button, return set values for all items in the *OPC UA Server Settings* to the default.

- 1 Double-click **OPC UA Server Settings** under **Configurations and Setup - OPC UA Settings** in Multiview Explore in the Sysmac Studio. Alternatively, right-click OPC UA Server Settings and select **Edit** from the menu.

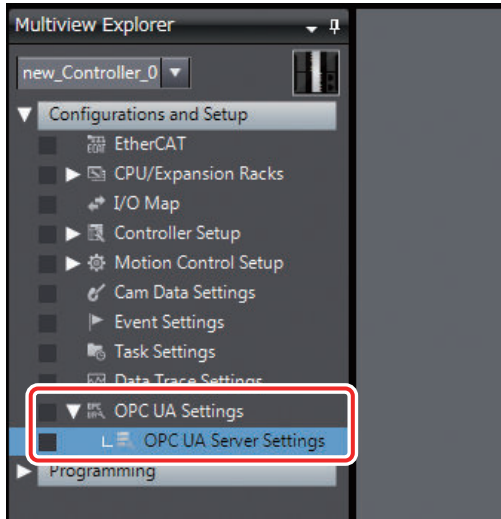

The following **OPC UA Server Settings** Tab Page is displayed.

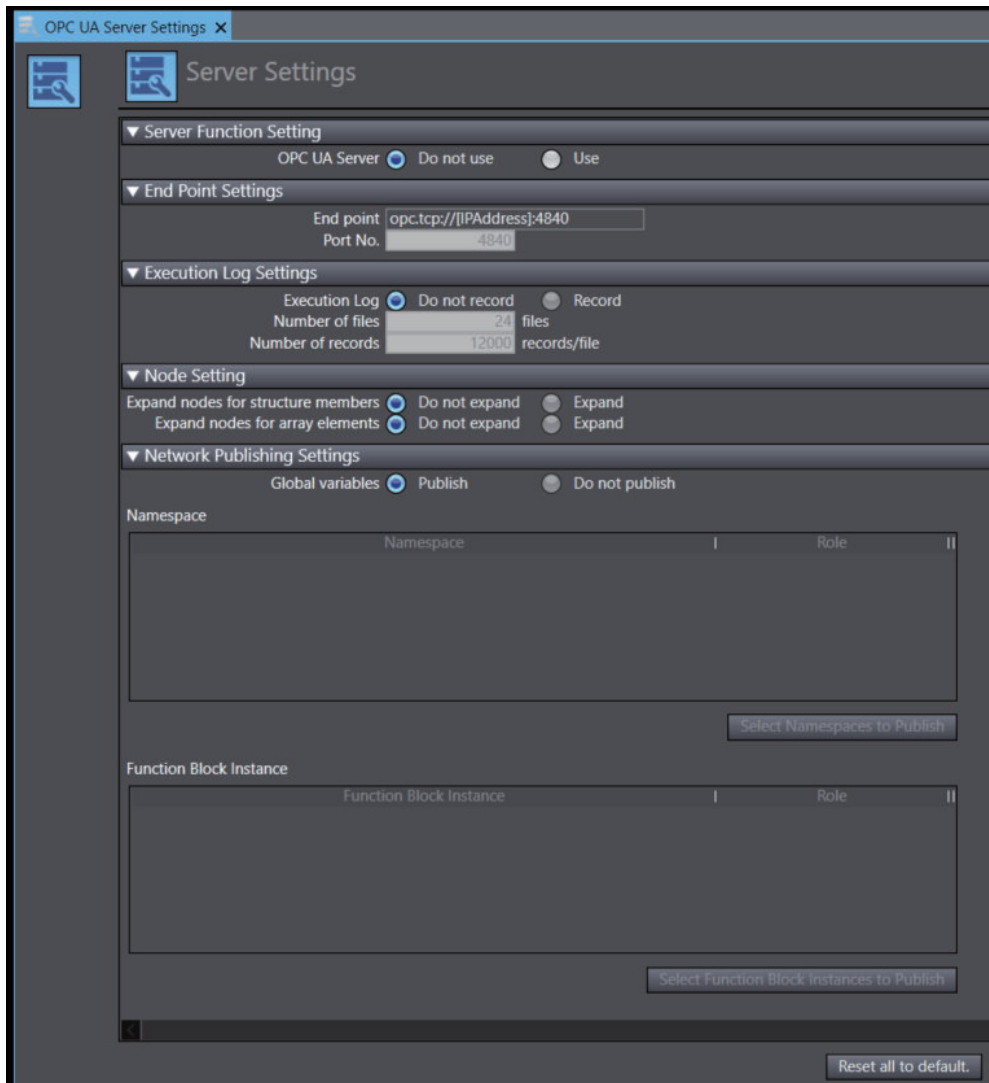

Use of the OPC UA Server

You can set whether to use the OPC UA Server in **Server Function Setting**.

Set the following items.

Parameter	Setting group	Description	Set value	Default	Update Timing	Changes in RUN mode
Server Settings	Server Function Setting	Set whether to use the OPC UA Server	<ul style="list-style-type: none"> Do not use Use 	Do not use	When downloaded to CPU Unit	Not allowed

After you download the project whose **OPC UA Server** in the OPC UA Settings was changed from *Do not use* to *Use* to the CPU Unit, and then cycle the power supply to the Controller or reset the Controller, the OPC UA Server will start automatically at that time.

For details on how to start the OPC UA, refer to *4-1 Starting or Stopping the OPC UA Server* on page 4-2.

End Point Settings

In the **End Point Settings**, display the end point and set the port number.

Set and display the following items.

Parameter	Setting group	Description	Set value or display value	Default	Update Timing	Changes in RUN mode
End Point Settings	End point	The End point notation of the OPC UA Server is displayed. <ul style="list-style-type: none"> The [IPAddress] section on the right column shows the IP address of the built-in EtherNet/IP port in the NJ/NX-series CPU Unit. The [Port] section on the right column automatically shows the value of the set Port No. shown below. 	opc.tcp:// [IPAddress]: [Port] Note Not allowed to set. Display only.	opc.tcp:// 192.168.250.1: 4840	---	---
	Port No.	Set the port number to be used for the OPC UA Server*1.	1025 to 65535	4840	When downloaded to CPU Unit	Not allowed

*1. It can be set only when OPC UA server is set to *Use*.



Precautions for Correct Use

- **The IP Address Displayed at the End Point**
The IP address that is displayed at the **End point** is the IP address of the built-in EtherNet/IP port.
For details on how to set the IP address from the Sysmac Studio, refer to the *NJ/NX-series CPU Unit Built-in EtherNet/IP Port User's Manual (Cat. No. W506)*.
The IP address of the built-in EtherNet/IP port can also be changed with the `ChangeIPAdr` (Change IP Address) instruction.
However, if you change the IP address by downloading the settings or executing the instruction after server certificate is generated automatically or manually, the IP address of the built-in EtherNet/IP port will not match that of the server certificate. As a result, the OPC UA client can not connect to the OPC UA Server. Then, a *Server Certificate Mismatch* event (event code: 15020000 hex) occurs. In that case, manually regenerate the server certificate or set the IP address back to the original address.
- **Duplication of Used Port Number with Other Communications Services**
Make sure that the port number set in **End point - Port No.** does not use the same port number used for other communications service (such as FTP server, HTTP server, CIP message, FINS/TCP, and system). For the port number used for the built-in EtherNet/IP port, refer to the *NJ/NX-series CPU Unit Built-in EtherNet/IP Port User's Manual (Cat. No. W506)*.
- A host name cannot be set for the IP address of the built-in EtherNet/IP port.

Execution Log Settings

Specify whether or not to record Execution Logs, and set each specification related to the logs in the **Execution Log Settings**.

Set the following items.

Parameter	Setting group	Description	Set value	Default
Execution Log Settings	Execution Log	Sets whether to record Execution Logs.	Do not record Record	Do not record
	Number of files	Sets the maximum number of files of the Execution Logs. When the maximum number of files is reached, the oldest file is deleted and a new file is created*1.	2 to 100	24
	Number of records	Sets the number of log records that can be contained in each Execution Log file*1.	100 to 65,536	12,000

*1. It can be set only when OPC UA server is set to *Use* and *Execution Log* is set to *Record*.
For details on the Execution Log, refer to *Section 7 Execution Log Functions* on page 7-1.



Precautions for Correct Use

The values of the Execution Log Settings are reflected in the CPU Unit when a project is downloaded (synchronized) from the Sysmac Studio.

Node Setting

In the **Node Setting**, set whether or not to expand and publish the node.

Set the following items.

Parameter	Setting group	Description	Set value	Default	Update Timing	Changes in RUN mode
Node Setting	Expand nodes for structure members*1	Set the node expansion of structure members.	<ul style="list-style-type: none"> Do not expand Expand*2 	Do not expand	When downloaded to CPU Unit	Not allowed
	Expand nodes for array elements*3	Set the node expansion of array elements.	<ul style="list-style-type: none"> Do not expand Expand*4 	Do not expand	When downloaded to CPU Unit	Not allowed

*1. This function can be set for the unit versions of the following CPU Units.

NJ501-1□□00: Version 1.48 or later

NX102-□□□□: Version 1.48 or later

NX502-1□□00: Version 1.64 or later

NX701-1□□□: Version 1.28 or later

*2. If you set it to **Expand**, you can publish members of a structure variable as one node. If members of a structure variable are published as one node, the number of members of the structure variable is counted as the number of public variables.

*3. This function can be set for the unit versions of the following CPU Units.

NJ501-1□□00: Version 1.62 or later

NX102-□□□□: Version 1.64 or later

NX502-1□□00: Version 1.64 or later

NX701-1□□□: Version 1.34 or later

*4. If you set it to **Expand**, you can publish array elements as one node. If array elements are published as one node, the number of array elements is counted as the number of public variables.

Relationship between Expand Nodes for Structure Members and Expand Nodes for Array Elements

The relationship of the settings for **Expand nodes for structure members** and **Expand nodes for array elements** in **Node Setting** is as follows.

Setting for Expand nodes for structure members	Setting for Expand nodes for array elements	One-dimensional structure array for global variables	One-dimensional structure array for variables other than global variables
Expand	Expand	Expand structures Expand arrays	Expand structures Expand arrays
Expand	Do not expand	Expand structures Expand arrays	Do not expand structures*1 Do not expand arrays
Do not expand	Expand	Do not expand structures Expand arrays	Do not expand structures Expand arrays
Do not expand	Do not expand	Do not expand structures Do not expand arrays	Do not expand structures Do not expand arrays

*1. Since array expansion is required to perform structure expansion, it becomes "Do not expand structures".

Network Publishing Settings

In the **Network Publishing Settings**, set whether or not to publish to network.

Set the following items.

Parameter	Setting group	Setting	Description	Set value	Default	Update Timing	Changes in RUN mode	
Network Publishing Settings	Global variables* ²	---	Set whether to publish variables according to the settings of the Network Publish attributes of global variables.	<ul style="list-style-type: none"> • Publish*¹ • Do not publish*² 	Publish	When downloaded to CPU Unit	Not allowed	
		Namespace* ^{2*3}	Namespace	Set the namespaces to be published to the OPC UA network.	Available namespaces	None	When downloaded to CPU Unit	Not allowed
			Role	Specify the OPC UA role that applies to the set namespace.	For the roles that can be set, refer to <i>Types of Role</i> on page 5-7.	None	When downloaded to CPU Unit	Not allowed
	Function Block Instance* ^{2*3*4}	Function Block Instance	---	Set the namespaces that you want to publish.	---	---	When downloaded to CPU Unit	Not allowed
			Function Block Instance	Set user-defined function block instance to be published to the OPC UA network.	Available function block instances	None	When downloaded to CPU Unit	Not allowed
	Function Block Instance* ^{2*3*4}	Function Block Instance	Role	Specify the OPC UA role that applies to the set user-defined function block instance.	For the roles that can be set, refer to <i>Types of Role</i> on page 5-7.	None	When downloaded to CPU Unit	Not allowed
			Function Block Instance	Set user-defined function block instance to be published to the OPC UA network.	Available function block instances	None	When downloaded to CPU Unit	Not allowed

Parameter	Setting group	Setting	Description	Set value	Default	Update Timing	Changes in RUN mode
		Select Function Block Instances to Publish Button	Set the function block instances that you want to publish.	---	---	When downloaded to CPU Unit	Not allowed

*1. You must set it for the unit versions of the following CPU Units.

- NJ501-1□□00: Version earlier than 1.62
- NX102-□□□□: Version earlier than 1.63
- NX502-1□□00: Version earlier than 1.63
- NX701-1□□□: Version earlier than 1.34

*2. You can set it for the unit versions of the following CPU Units.

- NJ501-1□□00: Version 1.62 or later
- NX102-□□□□: Version 1.64 or later
- NX502-1□□00: Version 1.64 or later
- NX701-1□□□: Version 1.34 or later

*3. You can specify whether or not to publish, regardless of the public settings of the global variables.

*4. There are the following conditions to publish the function block instances to the network.

- The function block instances you want to publish are registered in the variable table.
- A program with the assigned function block instances you want to publish is assigned to the task.

Note You can use the function block instances in level structure.

If you use them in level structure, the program to which the top function block instances are assigned must be assigned to the task.

3-2-3 When Necessary to Cycle the Power Supply to the Controller or Reset the Controller

You need to cycle the power supply to the Controller or reset the Controller in the following cases:

- Changing OPC UA Server Use Option*¹ under **OPC UA Settings** before downloading or restoring the setting to the CPU Unit, and to enable the changes

*1. That means either case of *Do not use to Use* or *Use to Do not use*.

- When the Clear All Memory is executed with *Use* that is set in OPC UA Server Use Option

When Data Is Downloaded or Restored after OPC UA Server Use Option Is Changed

If the OPC UA Server Use Option is changed, the following dialog box is displayed after the data is downloaded or restored.

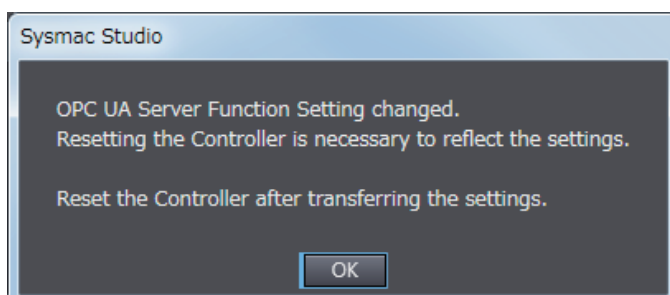

- 1 Click the **OK** Button.
- 2 Then, cycle the power supply to the Controller or reset the Controller.

After the Execution of Clear All Memory While the OPC UA Server Use Option Set to Use

When Clear All Memory is executed with the OPC UA Server Use Option set to *Use*, a similar dialog box is displayed. For details on how to perform Clear All Memory operation, refer to *8-3 Clear All Memory Function Related to the OPC UA Server* on page 8-9.

3-2-4 Automatic Generation of the Server Certificate

The server certificate is automatically generated in the following case:

- When you cycle the power supply to the Controller or reset the Controller after downloading the project whose **OPC UA Server** in the OPC UA Settings was changed from *Do not use* to *Use* to the CPU Unit
And
- When there is no server certificate in the CPU Unit

The value of the IP address of the automatically generated server certificate is generated from the IP address of the built-in EtherNet/IP port at the time.

If you change the IP address after the server certificate is generated automatically or manually, be sure to regenerate the server certificate manually. For details on how to operate, refer to *Regenerating the Server Certificate* on page 3-15 in *Server Certificate* on page 3-12 in *3-2-5 Setting and Displaying the Certificate* on page 3-12. If the IP address of the server certificate does not match the IP address of the built-in EtherNet/IP port, OPC UA clients can not connect to the OPC UA Server.

3-2-5 Setting and Displaying the Certificate

The following shows how to set and display the certificate and their contents.

The certificate setting can be operated only when online, and only by the *Administrator* in the operation authority verification settings.

The certificate can be displayed only when online, and only by the person other than *Observer* in the operation authority verification settings.

The certificate setting and display consists of the following contents:

- Server Certificate
- Client Authentication
- Issuer Authentication

Server Certificate

You can display and operate the server certificate in the CPU Unit connected online.

- 1 In the Sysmac Studio, connect online to the CPU Unit, right-click **OPC UA Server Settings** under **Configurations and Setup - OPC UA Settings** in Multiview Explorer and select **Server Certificate** from the menu.

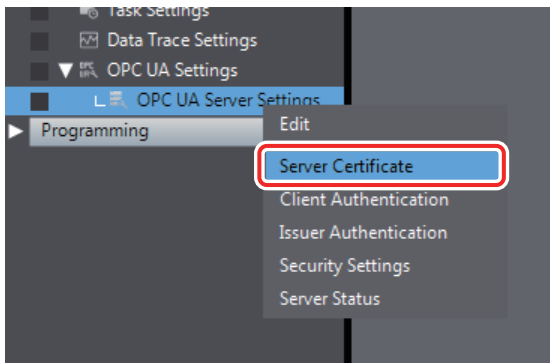

The current server certificate in the CPU Unit is acquired and displayed on the following **Server Certificate** Tab Page.

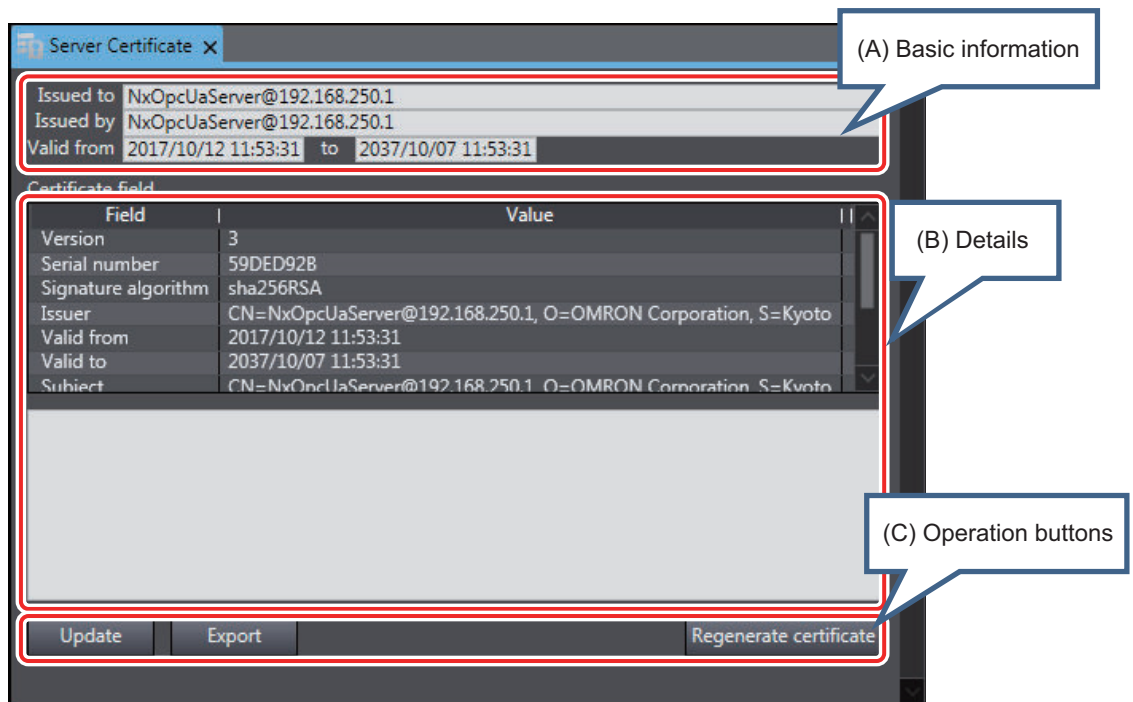

The following contents are displayed.

Classification	Item*1	Description	
(A) Basic information	Issued to	The common name of the subject is displayed.	Set to NxOpcUaServer@[IPAddress] in the case of server certificate. The [IPAddress] part is the IP address of the server certificate. Example) NxOpcUaServer@192.168.250.1
	Issued by	The issuer's common name is displayed.	
	Valid from	The start date and time and the end date and time of the validity period are displayed.	
(B) Details	Version	Version information of the certificate.	

Classification	Item*1	Description
	Serial number	Identification number of the certificate.
	Signature algorithm	Signature algorithm attached to the certificate.
	Issuer	Name of the issued CA. In the case of a server certificate, it is self-signed and is as follows: CN=NxOpcUaServer@[IPAddress]., O=Omron Corporation, L=Kyoto, S=Kyoto, C=JP Example: CN=NxOpcUaServer@192.168.250.1, O=Omron Corporation, L=Kyoto, S=Kyoto, C=JP
	Valid from	Start date and time of certificate validity period. Example: 2017/02/13 19:37:23
	Valid to	End date and time of certificate validity period. Example: 2027/02/13 19:37:23
	Subject	Owner of the public key. It is the same as the issuer. Example: CN=NxOpcUaServer@192.168.250.1, O=Omron Corporation, L=Kyoto, S=Kyoto, C=JP
	Type	---
	Public key	Public key of the applicant and its types.
	Thumbprint	Message digest of the CA.
	Detailed Text Box	Detailed information in the selected Certificate field is displayed. <ul style="list-style-type: none"> • Default status is empty. • Each element of the issuer is displayed in a new line. The IP address of the server certificate is displayed after the first line <i>CN=NxOpcUaServer@</i> . This is the IP address of the built-in EtherNet/IP port at the time when the server certificate was generated.
(C) Operation buttons	Update Button	The Server Certificate Setting Tab Page display is updated with the data in the CPU Unit. For details, refer to <i>Updating Server Certificate Tab Page</i> on page 3-14 below.
	Export Button	Export the Server certificate being displayed as an X.509 certificate file. For details, refer to <i>Exporting Server Certificate</i> on page 3-15 below.
	Regenerate certificate Button	Regenerate the secret key and the server certificate in CPU Unit on online connection. For details, refer to <i>Regenerating the Server Certificate</i> on page 3-15 below.

*1. For the meaning of each item, refer to X.509.



Precautions for Correct Use

The IP address after *CN=NxOpcUaServer@* displayed in the first line of the above **Detailed Text Box** must match that of the built-in EtherNet/IP port.
If it does not match, the OPC UA client can not connect to the OPC UA Server. Then, a *Server Certificate Mismatch* event (event code: 15020000 hex) will occur. In that case, manually regenerate the server certificate.

● Updating Server Certificate Tab Page

The display on the **Server Certificate** Tab Page is updated with the data in the CPU Unit connected online.

- 1 Click the **Update** Button to reacquire the Server Certificate in the CPU Unit and update the **Server Certificate** Tab Page display.

● Exporting Server Certificate

The server certificate is exported as X.509 certificate file.

- 1 When you click the **Export** Button, the following **Export server certificate** Dialog Box is displayed.

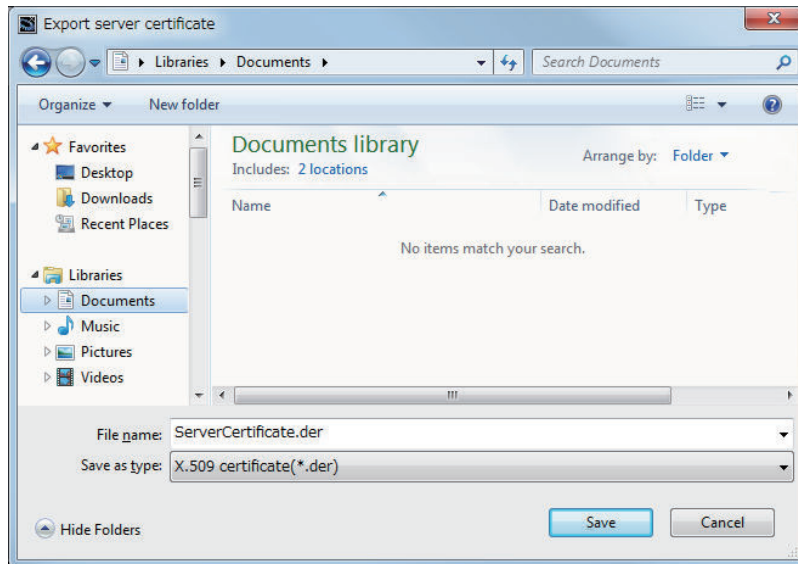

- The file type is *X.509 certificate*, and the identifier is **.der*.
- The default file name is *ServerCertificate.der*.

- 2 Click the **Save** Button to save the Server certificate file in the specified path.

Precautions for Correct Use

If you replace the CPU Unit or change the IP address of the CPU Unit and regenerate the Server certificate, export the Server certificate by the above operation and import it to the OPC UA client.

● Regenerating the Server Certificate

If you set the DN (Distinguished Name) information of the Server certificate and the validity period, you can regenerate the Server certificate in the CPU Unit manually.

The value of the IP address of the server certificate is generated from the IP address of the built-in EtherNet/IP port at the time of regeneration.

If you change the IP address after the server certificate is generated automatically, be sure to regenerate the server certificate manually. If the IP address of the server certificate does not match the IP address of the built-in EtherNet/IP port, OPC UA clients can not connect to the OPC UA Server.

- 1 When you click the **Regenerate certificate** Button, the following **Regenerate certificate** Dialog Box is displayed.

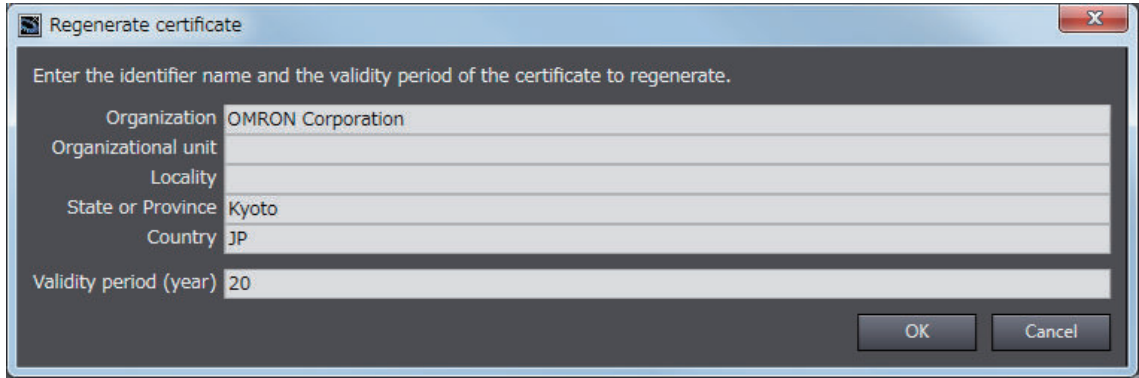

2 Set the following items.

Item	Effective character/range	Default value displayed on the Sysmac Studio	OPC UA Server is set to <i>Use</i> , and default value when the Controller power is turned ON	Omission
Organization name	0 to 9, a to z, A to Z, halfwidth space [], hyphen [-], dot [.], Underscore [_], comma [,], slash [/], parenthesis [(), closing parenthesis [)]	Value stored in the subject of the Certificate being displayed	OMRON Corporation	Cannot be omitted
Organizational unit name	Within 64 characters.		---	Can be omitted
Municipality			Kyoto	Cannot be omitted
Prefecture			Kyoto	Cannot be omitted
Country	Two half-width alphabetic characters		JP	Cannot be omitted
Validity period (years)	An integer from 1 to 20	20	20	Cannot be omitted

3 When you click the **OK** Button, the following confirmation dialog box is displayed.

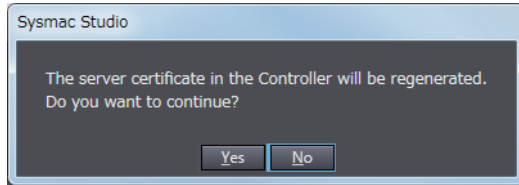

- 4 Click the **Yes** Button to regenerate the server certificate in the CPU Unit in the entered DN information and valid period. Click the **No** Button to close the confirmation dialog box and return to the state before execution.
After the server certificate is regenerated, communications with OPC UA clients cannot be performed as it is. To communicate with the OPC UA clients, export the server certificate and install it on the OPC UA client side. For information on how to export server certificates, refer to *Exporting Server Certificate* on page 3-15.

Client Authentication

You can display and operate self-signed client certificates in the CPU Unit connected online.



Additional Information

For the CA-signed client certificate, refer to *A-3 When CA-signed Client Certificates Supported* on page A-14.

- 1 In the Sysmac Studio, connect online to the CPU Unit, right-click **OPC UA Server Settings** under **Configurations and Setup - OPC UA Settings** in Multiview Explorer and select **Client Authentication**.

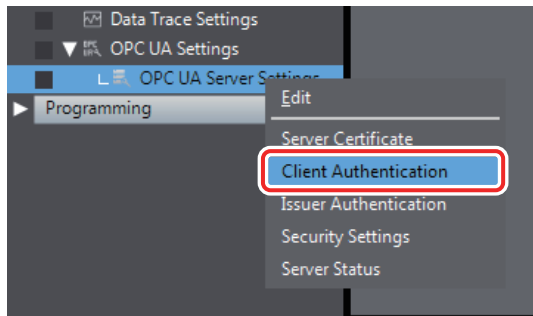

The following **Client Authentication** Tab Page is displayed.

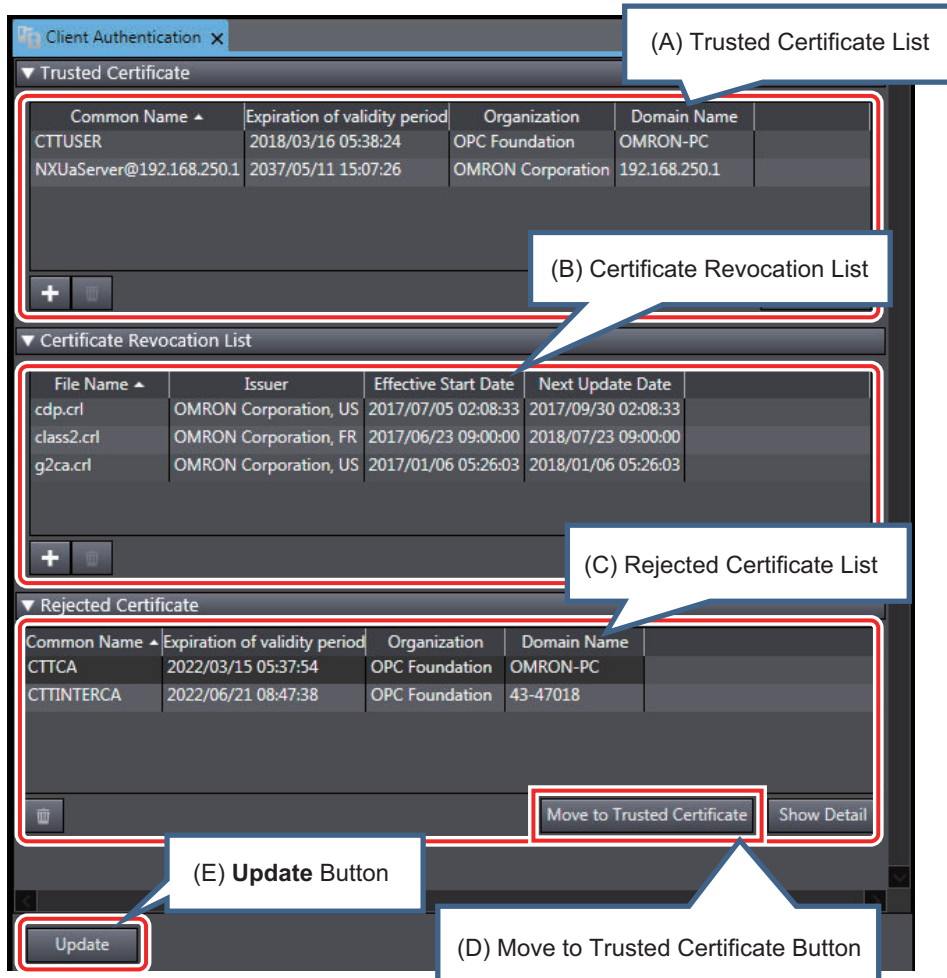

The following contents are displayed.

Parameter	Description
(A) Trusted Certificate List	<p>The Trusted Client Certificate List in the CPU Unit is displayed.</p> <ul style="list-style-type: none"> • Common name, expiration of validity period, organization, domain name are displayed. • The default display order is ascending order of common names. You can sort the list by the name of each item by clicking each column header. Ascending and descending order are switched each time you click.
(B) Certificate Revocation List	<ul style="list-style-type: none"> • Add Button (): Adds the certificate selected in the Add Certificate Dialog Box to the Trusted Certificate List in the CPU Unit. For details, refer to <i>Adding a Client Certificate (Transfer to the CPU Unit)</i> on page 3-19 below. • Delete Button (): Deletes the selected certificate from the Trusted Certificate List in the CPU Unit. For details, refer to <i>Deleting a Client Certificate</i> on page 3-21 below. • Show Detail Button: Display details of the selected certificate.

Parameter	Description
(C) Rejected Certificate List	<p>The rejected client certificate list in the CPU Unit is displayed.</p> <ul style="list-style-type: none"> • Delete Button (): Deletes the selected certificate from the Rejected Certificate List in the CPU Unit. • Show Detail Button: Display details of the selected certificate.
(D) Move to Trusted Certificate Button	<p>The Rejected Certificate List in the CPU Unit is moved to the Trusted certificate.</p> <ul style="list-style-type: none"> • Move to Trusted Certificate Button: Move the certificate selected in the Rejected Certificate List to the Trusted Certificate. For details, refer to <i>Permitting a Rejected Client Certificate</i> on page 3-22 below.
(E) Update Button	<p>The display in the Client Authentication Tab Page is updated with the data in the CPU Unit. For details, refer to <i>Updating the Client Authentication Tab Page</i> on page 3-23 below.</p>

● Client Certificate Constraints

The unit versions of CPU Units and character restrictions for common names in client certificates are as follows:

CPU unit model	Unit version of CPU Unit	Valid character	Number of characters
NJ501-1□□□	Version earlier than 1.60	0-9, A-Z, a-z, @,.,, -, \, /, :, *, ?, ", <, >,	44 characters max.
NX102-□□□□			
NX701-1□□□	Version earlier than 1.32		
NJ501-1□□□	Version 1.60 or later	No restrictions	
NX102-□□□□			
NX502-1□□□	Version 1.64 or later		
NX701-1□□□	Version 1.32 or later		

● Adding a Client Certificate (Transfer to the CPU Unit)

The client certificate file (extension.der) in the computer is added to the *Trusted Certificate List* in the CPU Unit.

- 1 Click the **Add Button** (). The following **Add Certificate** Dialog Box is displayed.

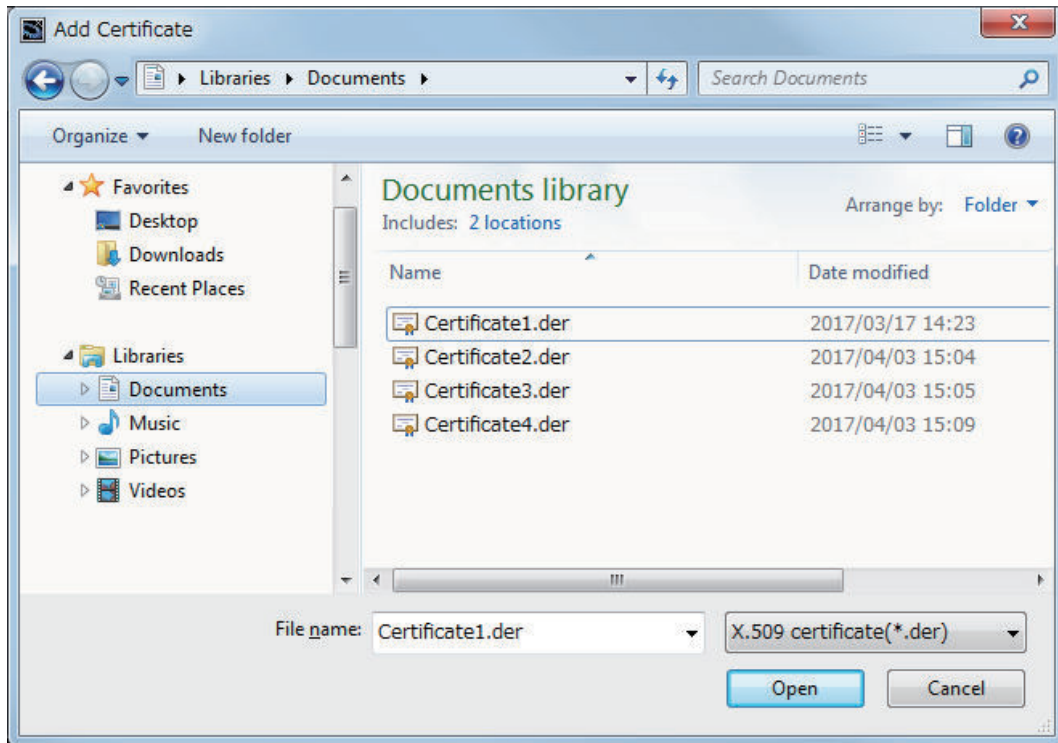

- 2 Select one or more client certificate files (extension.der) to be added, and click the **Open** Button.

The following dialog box to confirm the execution is displayed.

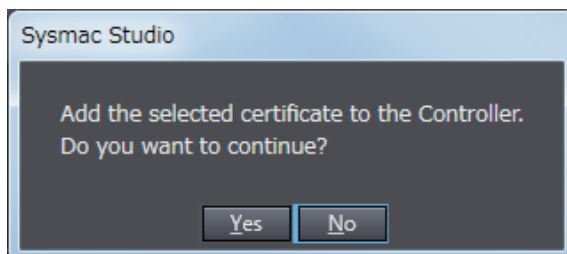

- 3 If you click the **Yes** Button, the selected client certificate is added to the Trusted Certificate List in the CPU Unit.

When the addition is successful, the following confirmation dialog box is displayed.

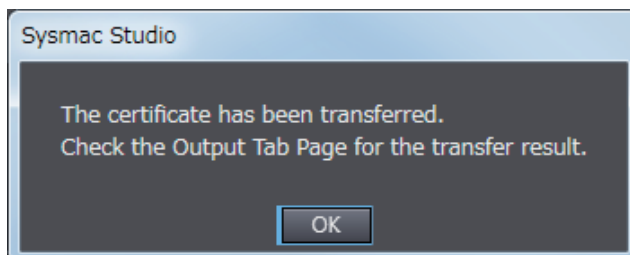

If the addition fails, the following confirmation dialog box is displayed.

- When the client certificate already exists in the Rejected Certificate List
If the client certificate to be added already exists in the *Rejected Certificate List* in the CPU Unit, the following confirmation dialog box is displayed.

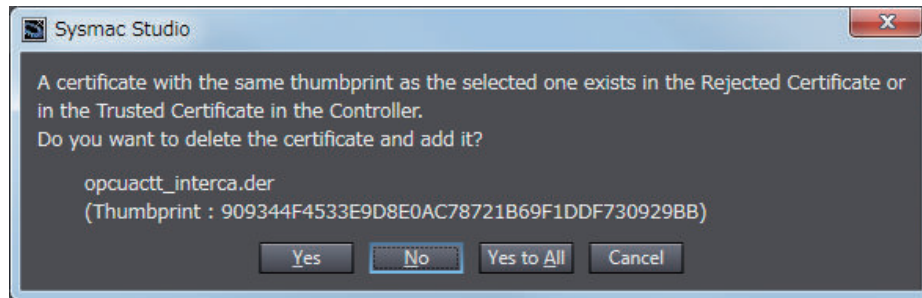

- When the client certificate already exists in the Trusted Certificate List
If the client certificate to be added already exists in the *Trusted Certificate List* in the CPU Unit, the following confirmation dialog box is displayed.

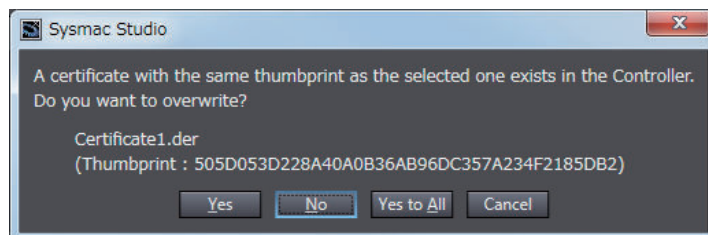

- When the transfer fails
If the client certificate cannot transfer when you cannot open a client certificate file to be added, the following confirmation dialog box is displayed.

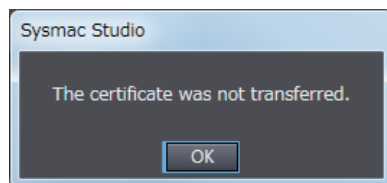

Precautions for Safe Use

Even if you accidentally add the client certificate of a client for which you do not want to permit connection in the *Trusted Certificate List*, the OPC UA Server of the NJ/NX-series Controller will permit connections from that client.

As a result, confidential information on the server side may be leaked or unintended operation may be performed. Therefore, when you add a certificate to the Trusted Certificate List from the Sysmac Studio, make sure that all the certificates that you will register in the *Trusted Certificate List* are trusted client certificates.

● Deleting a Client Certificate

You can delete the selected client certificate in the CPU Unit.

You can delete a certificate in the Trusted Certificate List and the Rejected Certificate List.

- 1 Select the client certificate you want to delete and click the **Delete** Button (). The following confirmation dialog box is displayed.

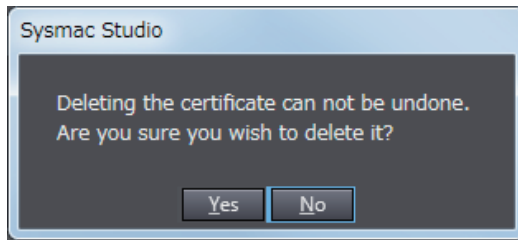

- 2 Click the **Yes** Button to delete the client certificate in the CPU Unit.

● Permitting a Rejected Client Certificate

You can move the selected client certificate from the Rejected Certificate List to the Trusted Certificate List in the CPU Unit.

- 1 Select the client certificate you want to move, and click the **Move to Trusted Certificate** Button.

The following **Processing** Dialog Box is displayed.

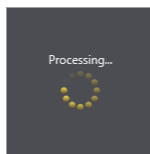

- 2 After a while, the client certificate in the CPU Unit is moved and the **Client Authentication** Tab Page display is updated to the latest information.

If the move fails, the following confirmation dialog box is displayed.

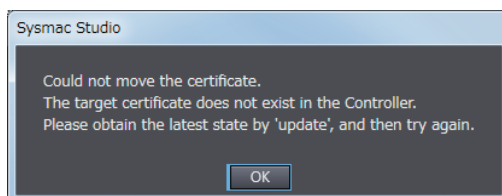

Additional Information

Automatic Addition of Client Certificates to the Rejected Certificate List

When an OPC UA client connects to the OPC UA Server and the client does not exist in the Trusted Certificate List, the client's certificate is automatically added to the Rejected Certificate List.

● Displaying the Detailed View of Certificates

If you want to display the detailed contents of the selected client certificate, perform the following operations.

- 1 Click the **Show Detail** Button.
The **Processing** Dialog Box is displayed.

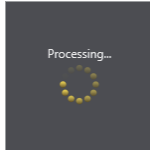

- 2** After a while, the detailed contents of the client certificate in the CPU Unit are displayed.

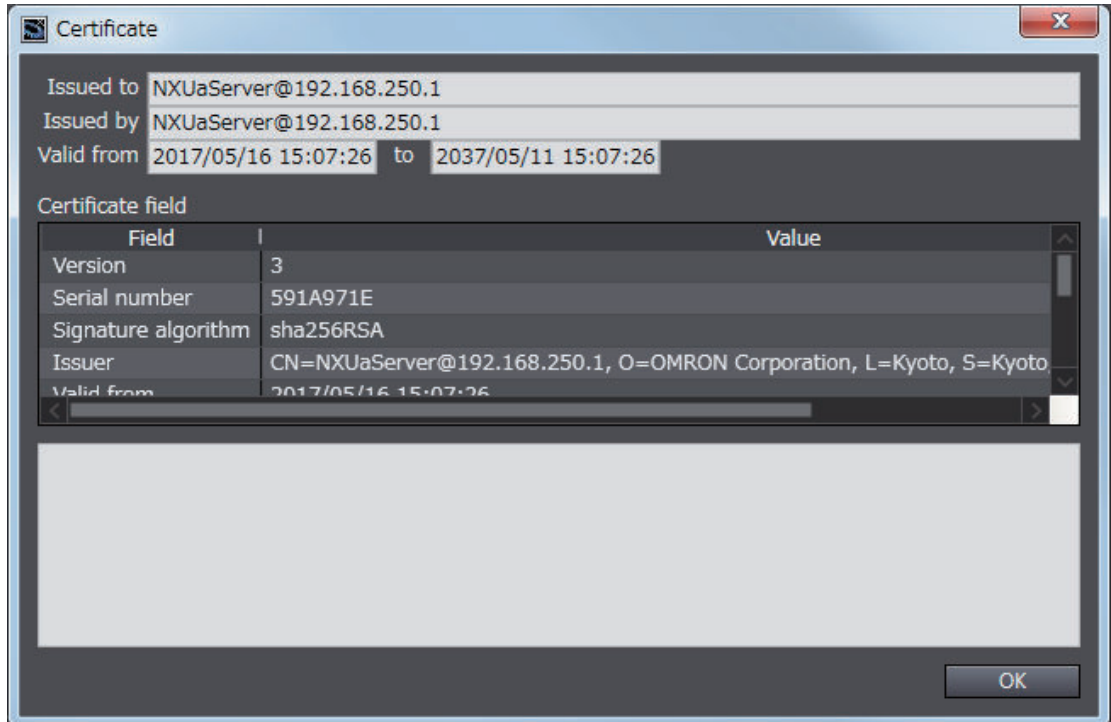

If the certificate details display fails, the following confirmation dialog box is displayed.

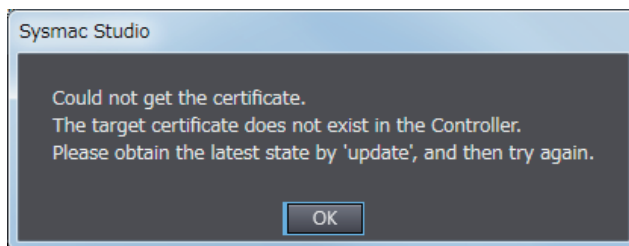

● Updating the Client Authentication Tab Page

The display on the **Client Authentication** Tab Page is updated with the data in the CPU Unit connected online.

- 1** Click the **Update** Button to reacquire the Client Certificate List in the CPU Unit and update the **Client Authentication** Tab Page display.



Additional Information

When a new OPC UA client connects to the server while a client certificate is displayed and operated, and the client does not exist in the Trusted Certificate List, the client's certificate will be automatically added to the Rejected Certificate List. In such a case, it is necessary to update the **Client Authentication** Tab Page.

Issuer Authentication

You can display and operate the certificate authority itself that signed the client certificate in the CPU Unit connected online. For details, refer to *A-3 When CA-signed Client Certificates Supported* on page A-14.

3-2-6 Security Settings

The following shows how to make the security settings and their contents.

The Security settings consist of the following contents.

- User Authentication Settings
- Anonymous login
- Security policy

The Security settings can be operated only when online, and only by the *Administrator* in the operation authority verification settings.

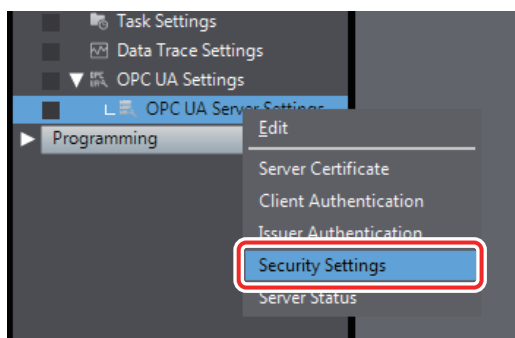

- 1 In the Sysmac Studio, connect online to the CPU Unit, right-click **OPC UA Server Settings** under **Configurations and Setup - OPC UA Settings** in Multiview Explorer and select **Security Settings** from the menu.

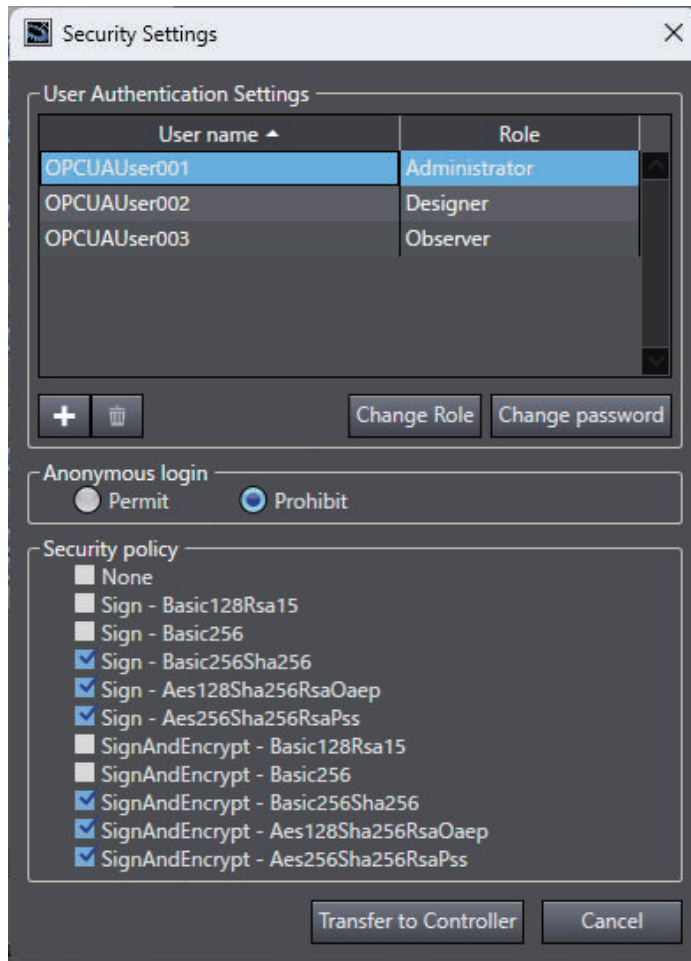

The following **Security Settings** Dialog Box is displayed.



Set the following items.

Parameter	Description	Set value	Default	Update Timing	Changes in RUN mode
User Authentication Settings	<p>The list of configured user names is displayed.</p> <ul style="list-style-type: none"> The default display order is the order stored in the user name settings file. You can sort by clicking the header of the user name. Ascending and descending order are switched each time you click. <ul style="list-style-type: none"> Add Button (): Adds the user name. For details, refer to <i>Adding a User Name</i> on page 3-28. Delete Button (): Deletes the selected user name. Change password Button: Changes the password of the currently selected user name. For details, refer to <i>Changing the Password</i> on page 3-29 below. Change Role Button: Selects the role to assign to the user name. 	User name* ¹ , password (up to 20 people), and role* ²	None	When clicking the Transfer to Controller Button	Not allowed.
Anonymous login	Sets whether to prohibit or permit anonymous logins.	<ul style="list-style-type: none"> Prohibit Permit 	Prohibit* ³		
Security policy	<p>Set the allowable range as the server of the Security Mode and Policy in the OPC UA specifications. Multiple checks are possible. For details on the specified items, refer to <i>5-2-2 OPC UA Security Mode and Policy</i> on page 5-9.</p>	<ul style="list-style-type: none"> None Sign - Basic128Rsa15 Sign - Basic256 Sign - Basic256Sha256 Sign - Aes128Sha256RsaOaep*⁴ Sign - Aes256Sha256RsaPss*⁴ SignAndEncrypt - Basic128Rsa15 SignAndEncrypt - Basic256 SignAndEncrypt - Basic256Sha256 SignAndEncrypt - Aes128Sha256RsaOaep*⁴ SignAndEncrypt - Aes256Sha256RsaPss*⁴ 	<p>Sign - Basic256Sha256, Sign - Aes128Sha256RsaOaep, Sign - Aes256Sha256RsaPss, SignAndEncrypt - Basic256Sha256, SignAndEncrypt - Aes128Sha256RsaOaep and SignAndEncrypt - Aes256Sha256RsaPss are selected. Others are not selected. *^{5*6}</p>		

Parameter	Description	Set value	Default	Update Timing	Changes in RUN mode
Transfer to Controller Button	Transfer the Security Settings (User authentication settings, anonymous login, and security policy) to the CPU Unit. For details, refer to <i>Transferring the Security Settings</i> on page 3-30 below for details.	---	---	---	---

*1. The restrictions on each entry of user name and password are as follows.

Item	Valid character	Range of characters	Default
User name	0 to 9, a to z, A to Z (case sensitive) Note The following are reserved words and cannot be set (not case insensitive). Administrator Designer Maintainer Operator Observer Anonymous	4 to 32 characters	Blank
Password	0 to 9, a to z, A to Z (case sensitive)	8 to 32 characters	Blank
Confirm Password	Same as password	Same as password	Blank

*2. Roles can be set for the unit versions of the following CPU Units.

NJ501-1□00: Version 1.62 or later
 NX102-□□□□: Version 1.64 or later
 NX502-1□00: Version 1.64 or later
 NX701-1□□□: Version 1.34 or later

*3. For the unit versions of the following CPU Units, the default setting is *Permit*.

NJ501-1□00: Version earlier than 1.43
 NX102-□□00: Version earlier than 1.43
 NX102-□□20: Version earlier than Ver.1.36

*4. You can select it for the unit versions of the following CPU Units.

NJ501-1□00: Version 1.64 or later
 NX102-□□□□: Version 1.64 or later
 NX502-1□00: Version 1.64 or later
 NX701-1□□□: Version 1.35 or later

*5. For the unit versions of the following CPU Units, the default setting for *None* is selected.

NJ501-1□00: Version earlier than 1.43
 NX102-□□00: Version earlier than 1.43
 NX102-□□20: Version earlier than Ver.1.36

*6. For the unit versions of the following CPU Units, *Sign - Basic128Rsa15*, *Sign - Basic256*, *SignAndEncrypt - Basic128Rsa15*, and *SignAndEncrypt - Basic256* are not selected.

NJ501-1□00: Version 1.62 or later
 NX102-□□□□: Version 1.64 or later
 NX502-1□00: Version 1.64 or later
 NX701-1□□□: Version 1.34 or later



Precautions for Correct Use

When you take security into consideration, be sure to clear *None*, *Sign - Basic128Rsa15*, *Sign - Basic256*, *SignAndEncrypt - Basic128Rsa15*, and *SignAndEncrypt - Basic256* under **Security Policy**.



Additional Information

If the OPC UA communications cannot be performed normally, check the consistency of anonymous login setting and security policy setting between the Controller and OPC UA client.

● Adding a User Name

Add a user name.

- 1 When you click the **Add Button** (), the following **Add a User** Dialog Box is displayed.

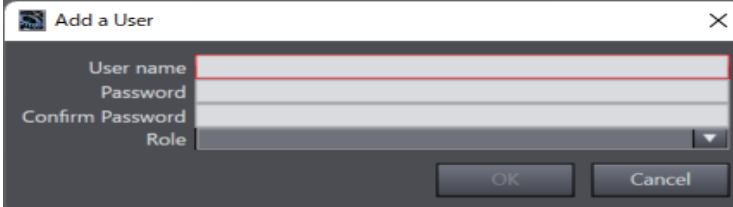

- 2 In the **User name** field, enter the user name, and enter the password in the **Password** and **Confirm Password** fields, and then click the **OK** Button.

● Setting Roles to User Names

If necessary, set a role for the user name.



Version Information

Roles can be set for the unit versions of the following CPU Units.

NJ501-1□□00: Version 1.62 or later
NX102-□□□□: Version 1.64 or later
NX502-1□□00: Version 1.64 or later
NX701-1□□□: Version 1.34 or later

- 1 Select the user name for which you set the role in the **User Authentication Settings**.

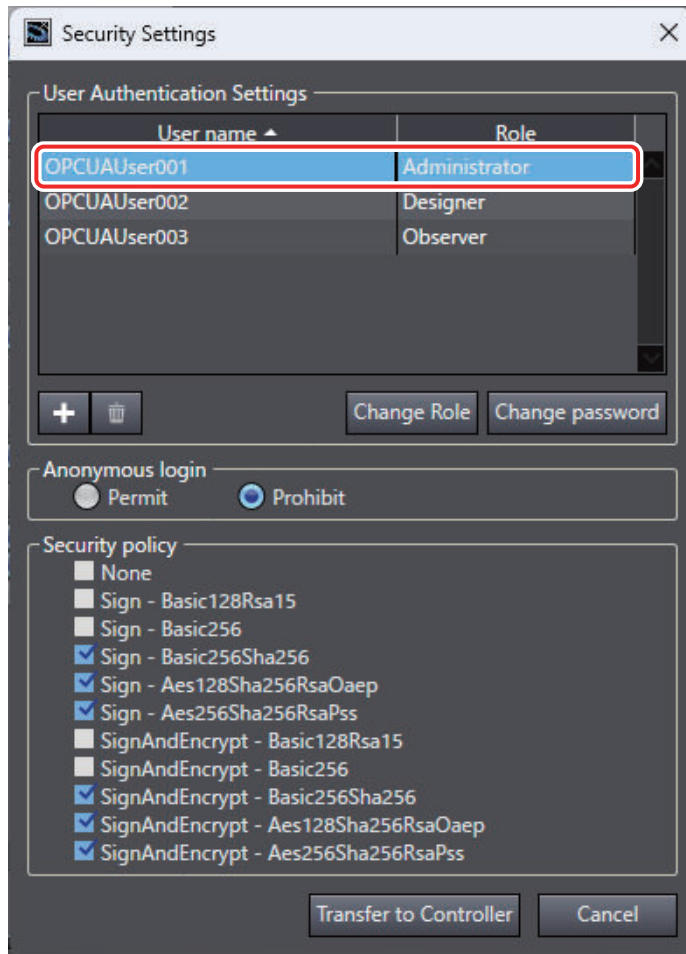

- 2** When you click the **Change Role** Button, the following dialog box is displayed.

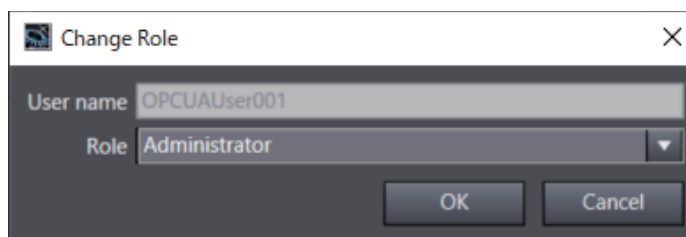

Refer to *5-1-3 Role Function* on page 5-6 for details on the role function.

- 3** Select the role from the drop-down list and click the **OK** Button.

● Changing the Password

Change the password of the currently selected user name.

- 1** Click the **Change password** Button, the following **Change Password** Dialog Box is displayed.

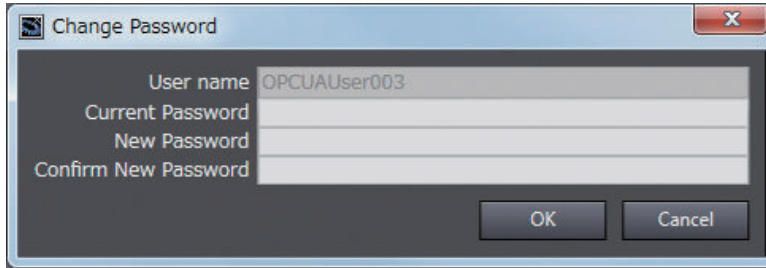

- 2 Enter the password in the fields of **Current Password**, **New Password**, and **Confirm New Password**, and click the **OK** Button.

● Transferring the Security Settings

The **Security Settings** (user authentication setting, anonymous login, and security policy) displayed in the Security Settings Tab Page are transferred to the CPU Unit.

- 1 Click the Transfer to Controller Button. The following dialog box is displayed.

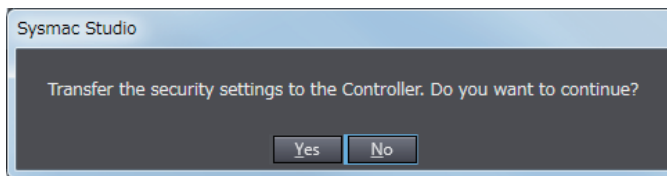

- 2 Click the **Yes** Button to transfer the User name, Password, and Role*¹ displayed in the User Authentication Settings to the CPU Unit.

*1. Roles can be used for the unit versions of the following CPU Units.

- NJ501-1□□00: Version 1.62 or later
- NX102-□□□□: Version 1.64 or later
- NX502-1□□00: Version 1.64 or later
- NX701-1□□□: Version 1.34 or later

When the transfer is successful, the following confirmation dialog box is displayed.

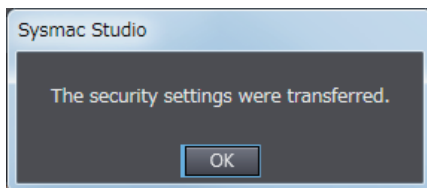

● Setting Roles for Nodes

Set roles for namespaces or instances in the user-defined function blocks.



Version Information

Roles can be set for the unit versions of the following CPU Units.

- NJ501-1□□00: Version 1.62 or later
- NX102-□□□□: Version 1.64 or later
- NX502-1□□00: Version 1.64 or later
- NX701-1□□□: Version 1.34 or later

- 1 Open the **Network Publishing Settings** in the **OPC UA Server Settings**.

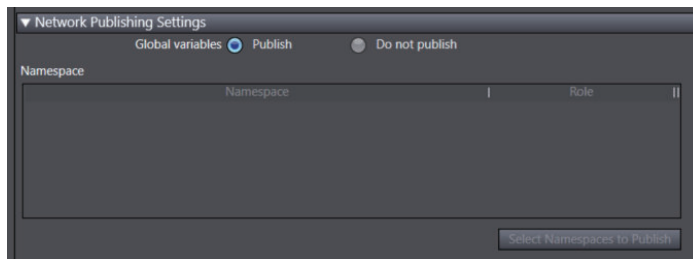

- 2 When you click the **Select Namespaces to Publish** Button, the **Select Namespaces to Publish** Dialog Box is displayed.
- 3 Select the check box of the namespace for which you want to set the role.
- 4 If necessary, select the role from the drop-down list and click the **OK** Button.

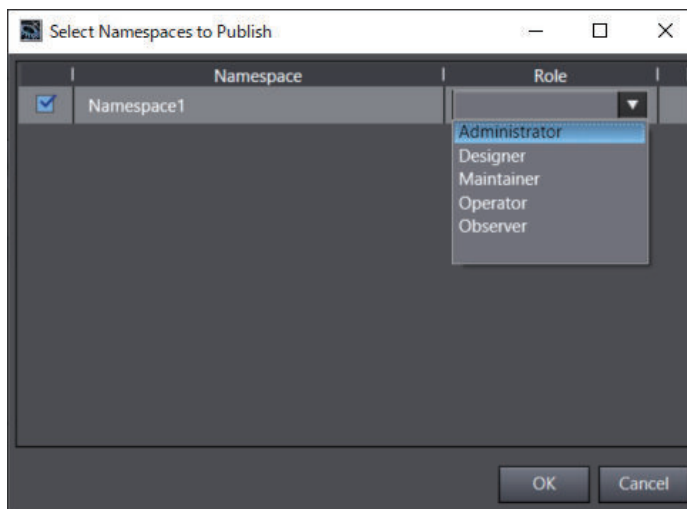

3-2-7 Server Status

You can check the status of the OPC UA Server such as the operating status of the OPC UA Server and the number of connected clients.

You can also instruct the shutdown of the OPC UA Server from the Sysmac Studio.

For details, refer to *4-2-1 Checking Based on OPC UA Server Status of the Sysmac Studio* on page 4-5.

3-2-8 Displaying the Operation Logs

You can display a list of the Execution Logs in the SD Memory Card mounted in the CPU Unit and operate the list.

For details, refer to *7-2-2 Checking Logs in the Operation Log Window in the Sysmac Studio* on page 7-15.



Additional Information

In view of future expansion of functions, in the Sysmac Studio, the display of the Execution Logs is placed under the *Operation Log Display* as the lower level of the upper concept *Operation Log*.

3-2-9 Operations for the OPC UA Settings

The following table shows whether the setting data of the OPC UA Settings is applied for each operation of synchronization (transfer), backup or restore, or Clear All Memory.

OK: Applicable, AS: Applicable by selection, NA: Not applicable

Setting data of OPC UA Settings		Operations				Clear All Memory operation from the Sysmac Studio
		Synchronization (transfer) from the Sysmac Studio	Backup	Restore		
			One of the following cases: • SD Memory Card Backup functions • Sysmac Studio Controller backup functions	When one of the following methods is used: • SD Memory Card Backup function • Sysmac Studio Controller Backup function	When one of the following methods is used: • Automatic transfer from SD Memory Card • Program transfer from SD Memory Card	
OPC UA Server settings		OK	OK	OK	OK	Clear
Server certificate		NA	NA	NA	NA	Select whether to clear or not.
OPC UA security profile	Client certificate	NA	OK*1	AS*2	NA	
	CA certificate					
	Certificate Revocation List					
	Security settings (User authentication settings, anonymous login, and security policy)					
Execution Log		NA	NA	NA	NA	Do not clear

*1. Client certificates, CA certificates, Certificate Revocation Lists, and Security Settings are not applicable when exporting and importing backup files in the Sysmac Studio.

*2. Whether to restore or not can be selected below.

- When the SD Memory Card backup function is used: Depends on the restore command file (Restore-Command.ini).
- When the Sysmac Studio Controller backup function is used: Depends on selecting the *data to restore* in the **Restore** Dialog Box.

3-3 Creating Variables for OPC UA Communications

This section describes how to create variables for OPC UA communications.

The following variables can be used as variables for OPC UA communications.

Type	Reference
Global variables*1	3-3-1 Global Variables Published to OPC UA Communications on page 3-33
Variables in user-defined function blocks	3-3-2 Variables in User-defined Function Blocks Published to OPC UA Communications on page 3-34
Variables based on companion specifications	3-3-3 Variables Based on Companion Specifications Published to OPC UA Communications on page 3-36

*1. System-defined variables cannot be published to OPC UA communications.

Refer to 6-2 Reading/Writing Variables from the OPC UA Client on page 6-3 for details on the variables that can be published and restrictions.

3-3-1 Global Variables Published to OPC UA Communications

To publish global variables to the OPC UA communications, the attributes of variables are set to *Network Publish Attribute*.

- 1 In the Global Variable Editor of the Sysmac Studio, set the *Network Publish* attribute of the global variable to *Publish Only*, *Input*, or *Output*.

Variables in which these attributes are set are called *variables published to the network*.

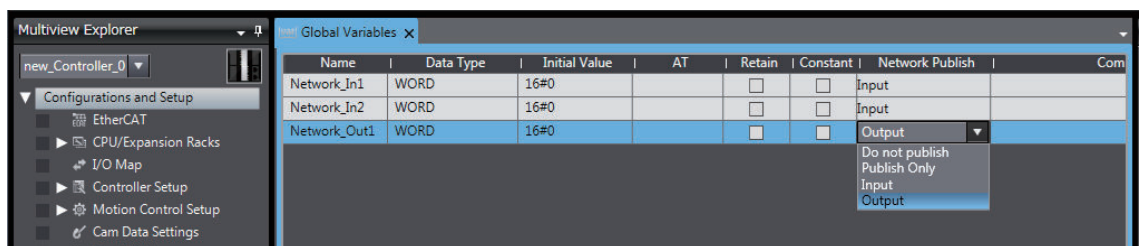

If a variable is published to the network, it can be read and written from the OPC UA client. The possibility of reading from or writing to the OPC UA client in accordance with the network publish attribute is as follows.

Attributes of Variables	Set value	Possibility of reading from or writing to the OPC UA client	
		Read	Write
Network Publish Attribute	Do not publish (default value in the Sysmac Studio).	No	No
	Publish Only	Yes	Yes
	Input	Yes	Yes
	Output	Yes	Yes



Additional Information

- *Publish Only*, *Input*, and *Output* in the *Network Publish* attribute are settings shared with EtherNet/IP communications. As for OPC UA communications, there is no difference between *Publish Only*, *Input*, and *Output*.
- If you do not publish the global variables, make the setting as follows.
Set **Global variables** to **Do not publish** from **OPC UA Server Settings – Network Publishing Settings** on the Sysmac Studio.

3-3-2 Variables in User-defined Function Blocks Published to OPC UA Communications

To publish variables in user-defined function blocks to the OPC UA communications, set the namespace or function block instance in **Network Publishing Settings**.

This function can be used together with the function described in 3-3-1 *Global Variables Published to OPC UA Communications* on page 3-33.

When you use only the function described in 3-3-2 *Variables in User-defined Function Blocks Published to OPC UA Communications* on page 3-34, without using functions described in 3-3-1 *Global Variables Published to OPC UA Communications* on page 3-33 and 3-3-3 *Variables Based on Companion Specifications Published to OPC UA Communications* on page 3-36, you can avoid duplication of global variables and variables to be published to the EtherNet/IP network.



Version Information

The variables in user-defined function blocks can be set to publish to OPC UA communications with the unit versions of the following CPU Units.

- NJ501-1□□00: Version 1.62 or later
- NX102-□□□□: Version 1.64 or later
- NX502-1□□00: Version 1.64 or later
- NX701-1□□□: Version 1.34 or later

1 If you specify namespaces and publish variables, make the following settings.

- 1) Open the **Network Publishing Settings** in the **OPC UA Server Settings**.

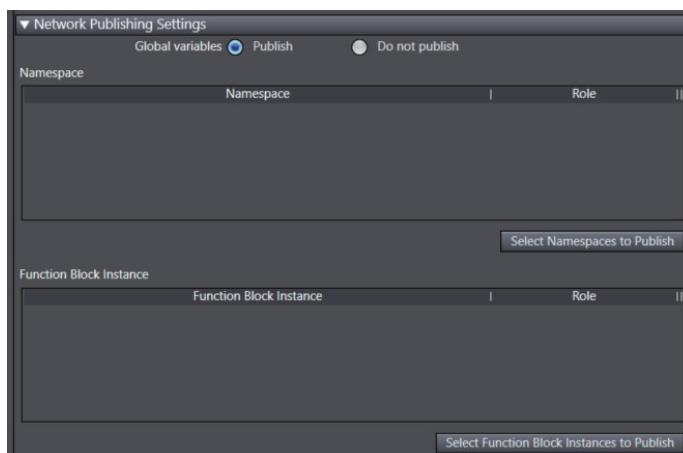

- 2) When you click the **Select Namespaces to Publish** Button, the **Select Namespaces to Publish** Dialog Box is displayed.
- 3) Select a namespace.

- 4) If necessary, select a role from the drop-down list and click the **OK** Button.

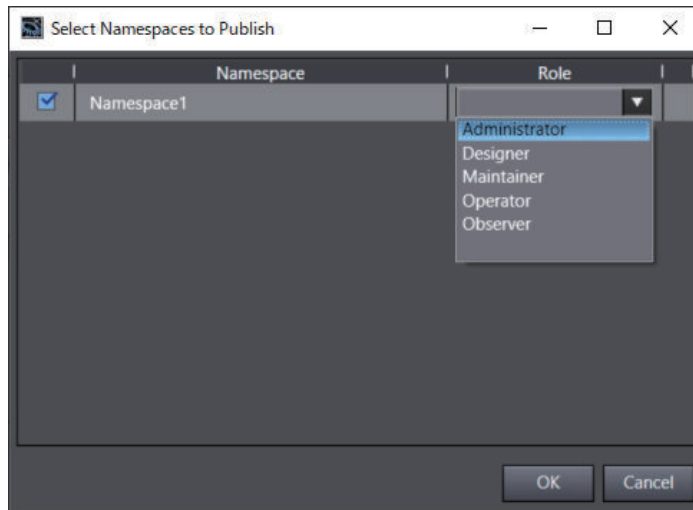

The namespace in which you set the role is displayed.

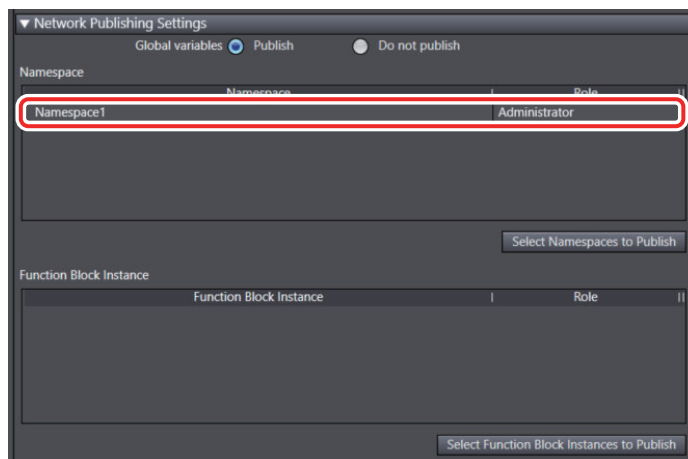

- 2** If you specify function block instances and publish variables, make the following settings.
- 1) Open the **Network Publishing Settings** in the **OPC UA Server Settings**.

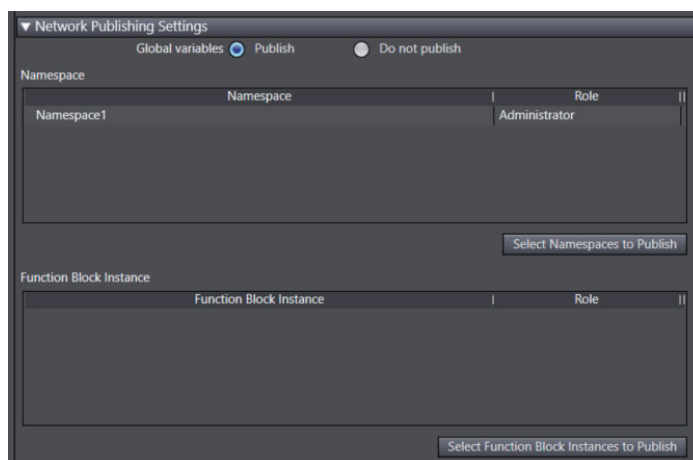

- 2) When you click the **Select Function Block Instances to Publish** Button, the **Select Function Block Instances to Publish** Dialog Box is displayed.
- 3) Select a function block instance.
- 4) If necessary, select a role from the drop-down list and click the **OK** Button.

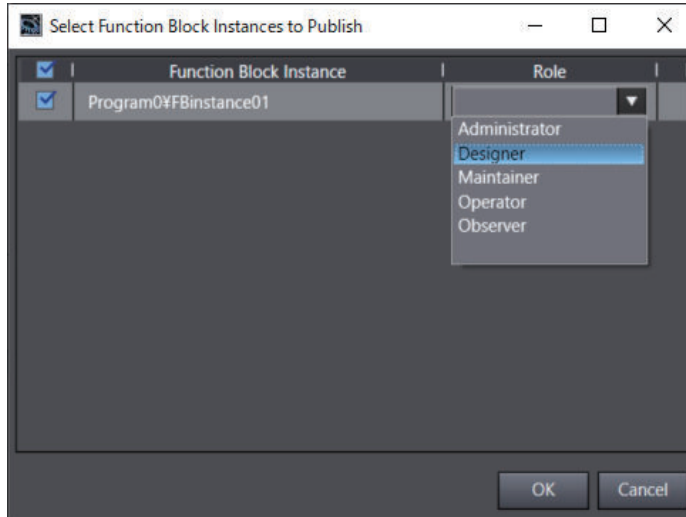

The function block instance for which the role was set is displayed.

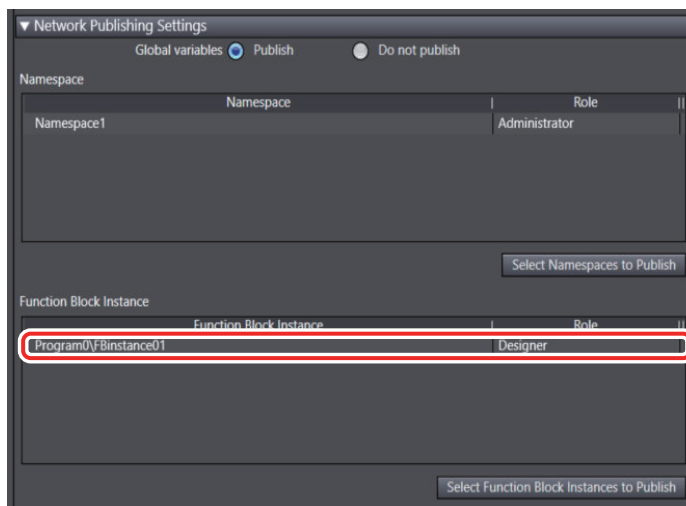

Additional Information

You can use the specifications of namespaces and function block instances at the same time.



Precautions for Correct Use

There are the following conditions to publish the function block instances to OPC UA communications.

- The function block instances you want to publish are registered in the variable table.
- A program with the assigned function block instances you want to publish is assigned to the task.

Note You can use the function block instances in level structure.

If you use them in level structure, the program to which the top function block instances are assigned must be assigned to the task.

3-3-3 Variables Based on Companion Specifications Published to OPC UA Communications

To publish variables in the function blocks associated with the companion specifications to OPC UA communications, set the namespace in **Network Publishing Settings**.

Version Information

If the variables in the function blocks associated with the companion specifications are published to OPC UA communications, you can make the settings with the unit versions of the following CPU Units.

NJ501-1□□00: Version 1.62 or later

NX102-□□□□: Version 1.64 or later

NX502-1□□00: Version 1.64 or later

NX701-1□□□□: Version 1.34 or later

- 1 Open the **Network Publishing Settings** in the **OPC UA Server Settings**.

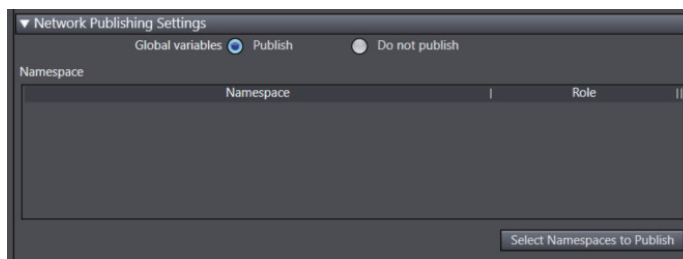

- 2 When you click the **Select Namespaces to Publish** Button, the **Select Namespaces to Publish** Dialog Box is displayed.

- 3 Select a namespace.

- 4 If necessary, select a role from the drop-down list and click the **OK** Button.

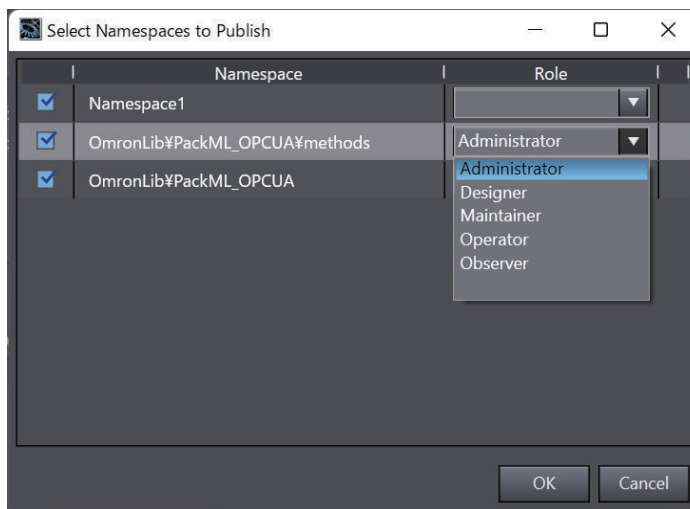

The namespace in which you set the role is displayed.

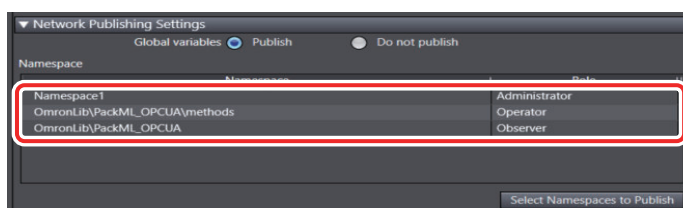



Precautions for Correct Use

- If the variables in the function blocks associated with the companion specifications are published to OPC UA communications, you cannot specify function block instances and publish variables.
 - There are the following conditions to publish the function block instances to OPC UA communications.
 - The function block instances you want to publish are registered in the variable table.
 - A program with the assigned function block instances you want to publish is assigned to the task.
- Note** You can use the function block instances in level structure.
 If you use them in level structure, the program to which the top function block instances are assigned must be assigned to the task.

3-3-4 Differences in Method to Publish Variables between User-defined and Companion Specifications

There is a difference in method to publish user-defined variables and companion specifications variables.

Specification method of variables to be published	Method to publish
Specify the user-defined namespace and instance	<p>According to the PLC Open OPC UA Information Model, programs, function blocks, and variables are published in level structure.</p> <pre style="border: 1px solid black; padding: 10px;"> ┆ Root ┆ Objects ┆ DeviceSet ┆ PackMLObjects ┆ Server ┆ new_Controller_0 ┆ DeviceStatus ┆ GlobalVars ┆ NumOfValues ┆ NumOfVars ┆ Programs ┆ MachinesPG ┆ Machine1 ┆ Admin_ModeCumulativeTime </pre>
Specify the namespace of companion specifications	<p>As defined in the companion specifications, nodes and variables are published.</p> <pre style="border: 1px solid black; padding: 10px;"> ┆ Root ┆ Objects ┆ DeviceSet ┆ PackMLObjects ┆ Machine1 ┆ Admin ┆ AccTimeSinceReset </pre>



Version Information

The user-defined variables and variables for companion specifications can be published to the OPC UA client for the unit versions of the following CPU Units.

NJ501-1□□00: Version 1.62 or later

NX102-□□□□: Version 1.64 or later

NX502-1□□00: Version 1.64 or later

NX701-1□□□: Version 1.34 or later

3-3-5 Adding or Deleting Network-published Variables

You can add or delete network-published variables by editing the settings and then downloading (synchronization) them.

4

Starting and Checking the Status of the OPC UA Server

This section describes how to start or stop the OPC UA Server, and also how to check the status of the OPC UA Server.

4

4-1	Starting or Stopping the OPC UA Server	4-2
4-1-1	How to Start or Stop the OPC UA Server	4-2
4-1-2	Conditions under Which the OPC UA Server Cannot be Started	4-3
4-1-3	Conditions under Which the OPC UA Server Stops	4-3
4-1-4	Operation of the OPC UA Service Function in each State of the CPU Unit	4-4
4-2	Checking the Status of the OPC UA Server	4-5
4-2-1	Checking Based on OPC UA Server Status of the Sysmac Studio	4-5
4-2-2	Checking Based on the Event Log	4-7
4-2-3	Checking Based on the Execution Log	4-7
4-2-4	Operating Status of the OPC UA Server	4-7
4-2-5	Conditions for Reconfiguring the OPC UA Server	4-9

4-1 Starting or Stopping the OPC UA Server

This section describes how to start or stop the OPC UA Server.

4-1-1 How to Start or Stop the OPC UA Server

The method of starting and stopping the OPC UA Server and the method of starting the OPC UA Server after stopping it are described below.

Starting the OPC UA Server

The method of starting the OPC UA Server is as below.

- 1** In the Multiview Explorer of the Sysmac Studio, double-click **OPC UA Server Settings** under **Configurations and Setup - OPC UA Settings**. Or, right-click OPC UA Server Settings and select **Edit** from the menu.
- 2** Select *Use* Option for **OPC UA Server** under **OPC UA Settings - OPC UA Server Settings**. The factory default setting is *Do not use* (Stop).
- 3** Place the Sysmac Studio online with the CPU Unit and download (synchronize) *OPC UA Settings*.
- 4** Cycle the power supply to the Controller or reset the Controller.
The OPC UA Server Use Option is enabled and the OPC UA Server starts.



Precautions for Correct Use

When you download (synchronize) or restore the *OPC UA Settings* by changing **OPC UA Server** to *Use* from *Do not use*, you must either cycle the power supply to the Controller or reset the Controller in order to start the OPC UA Server. The OPC UA Server will not start unless you cycle the power supply to the Controller or reset the Controller.

Stopping the OPC UA Server

Either of the following methods can be used to stop the OPC UA Server.

- **Method a) Executing the OPCUA_Shutdown (Shutdown OPC UA Function) instruction from the user program**

For the OPCUA_Shutdown (Shutdown OPC UA Function) instruction, refer to A-2-1 *OPCUA_Shutdown (Shutdown OPC UA Function)* on page A-9.

- **Method b) Shutting down from the Sysmac Studio**

- 1 Place the Sysmac Studio online with the CPU Unit, right-click **OPC UA Server Settings** under **Configurations and Setup - OPC UA Settings** in the Multiview Explorer, and then select **Server Status**.
- 2 Click the **Server shutdown** Button.

Starting the OPC UA Server after Stopping It

To start the OPC UA Server after shutting it down, either cycle the power supply to the Controller or reset the Controller.

4-1-2 Conditions under Which the OPC UA Server Cannot be Started

The OPC UA Server cannot be started in the following cases.

- When the OPC UA Server is in the *Halt error* state
- When the Controller power is not turned ON again, or the Controller is not reset after the OPC UA Server is in *Shutdown* state
- When the Controller power is not turned ON again or the Controller is not reset after the **OPC UA Server** is changed from *Use* to *Do not use* and the *OPC UA Settings* are downloaded (synchronized) or restored.

4-1-3 Conditions under Which the OPC UA Server Stops

The OPC UA Server stops in the following cases.

- When shutdown of the OPC UA Server is instructed from the Sysmac Studio or the OPCUA_Shutdown (Shutdown OPC UA Function) instruction is executed
- When the Controller power is turned ON again or the Controller is reset after the **OPC UA Server** is changed from *Use* to *Do not use* and the *OPC UA Settings* are downloaded (synchronized) or restored
- When the data is restored from the SD Memory Card or the Sysmac Studio
- When the Clear All Memory operation is executed from the Sysmac Studio



Additional Information

- The OPC UA Server continues to operate even when a major fault level Controller error occurs.
- When a Controller error occurs and you refer to the address space of the NJ/NX-series Controller from the OPC UA client, you can check the following from *ErrorStatus* under *DeviceStatus*.
 - a) NoError: Normal
 - b) MajorFault: Major fault
 - c) ContinuousError: Partial fault or minor fault

4-1-4 Operation of the OPC UA Service Function in each State of the CPU Unit

The execution state of the OPC UA service function changes depending on the state of the CPU Unit. The operation of the OPC UA service function in the *startup state*, *normal operation*, and *error state* is described below.

Process of CPU Unit		OPC UA Service function
Operation during startup state		Stopped.
Operation during normal operation	PROGRAM mode	Executed.
	RUN mode	Executed.
	Downloading	Stopped.
	During online editing	Executed.
	During backup	Executed.
	During restore operation, after restore operation	Stopped. The power supply must be cycled or the Controller must be reset after restoring data.
	During execution of Clear All Memory operation, after execution of Clear All Memory operation	Stopped. The power supply must be cycled or the Controller must be reset after the execution of Clear All Memory operation.
Error state	Major fault	Executed. However, stopped during a CPU error (WDT error).
	Partial fault	Executed. However, stopped during an OPC UA Server error.
	Minor fault	Executed. However, may be stopped during an OPC UA Server error.

4-2 Checking the Status of the OPC UA Server

This section describes how to check the status of the OPC UA Server.

You can use the following methods to check the status of the OPC UA Server.

- OPC UA server status of the Sysmac Studio
- Event log
- Execution Log

4-2-1 Checking Based on OPC UA Server Status of the Sysmac Studio

The method of checking the server status and its contents are described below.

The server status can be operated only in the online state.

- 1 Place the Sysmac Studio online with the CPU Unit, right-click **OPC UA Server Settings** under **Configurations and Setup - OPC UA Settings** in the Multiview Explorer, and then select **Server Status**.

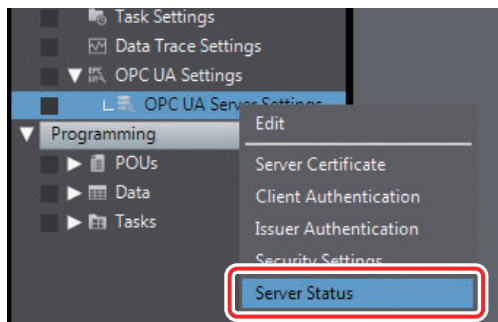

The following **Server Status** Tab Page is displayed.

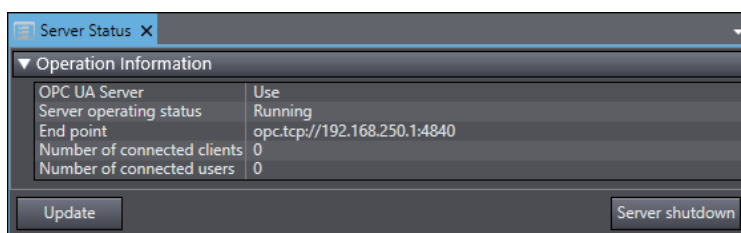

You can check the following states unless the operating status of the OPC UA Server is *Initializing* or *Shutdown*.

Category	Item	Description
Operation Information	OPC UA Server	Displays the setting status of the OPC UA Server. Any one of the following is displayed. <ul style="list-style-type: none"> • Use • Do not use

Category	Item	Description
	Server operating status	Displays the operating status of the OPC UA Server. Any one of the following is displayed. <ul style="list-style-type: none"> • Initializing • Preparing • Running • Halt error • Shutdown Refer to 4-2-5 <i>Conditions for Reconfiguring the OPC UA Server</i> on page 4-9 for details on the operating status.
	End point	Displays the end point of the OPC UA Server. <ul style="list-style-type: none"> • The end point is displayed only when the server operating status is <i>Running</i>. • When the server operating status is other than the above, “---” is displayed.
	Number of connected clients	Displays the number of currently connected OPC UA clients. <ul style="list-style-type: none"> • “---” is displayed only when the server operating status is <i>Initializing</i>. • When the server operating status is other than the above, the number of connected clients is displayed.
	Number of connected users	Displays the number of currently connected users.
Buttons	Update Button	Acquires the operation information from the server and updates the Server Status Tab Page.
	Server shutdown Button	Shuts down the server function. For details, refer to <i>Shutting Down the Server Function</i> on page 4-6 below.

● Shutting Down the Server Function

Shutdown the OPC UA Server.

- 1 When you click the **Server shutdown** Button, the following confirmation dialog box is displayed.

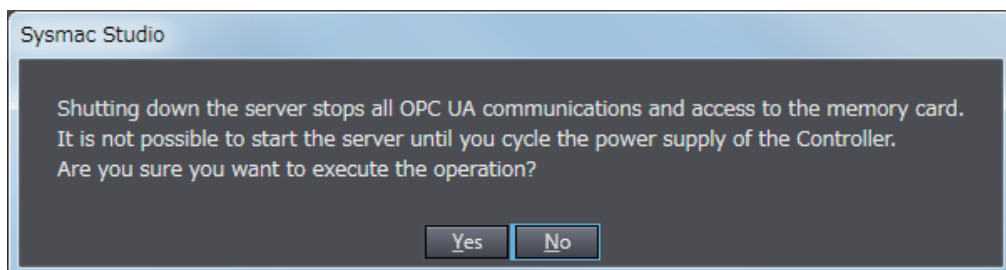

- 2 Click the **Yes** Button. The following dialog box is displayed.

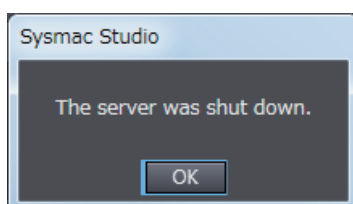

4-2-2 Checking Based on the Event Log

You can check the operating status of the OPC UA Server by the event log of the Controller. For details, refer to the *NJ/NX-series Troubleshooting Manual (Cat. No. W503)*.

4-2-3 Checking Based on the Execution Log

You can check the operating status of the OPC UA Server by the Execution Log function of the OPC UA Server.

For details, refer to *Section 7 Execution Log Functions* on page 7-1.

4-2-4 Operating Status of the OPC UA Server

This section describes the operating status of the OPC UA Server.

The OPC UA Server has five operation states, such as *Initializing*, *Preparing*, *Running*, *Halt error*, and *Shutdown*. The operating status transits as shown in the figure below.

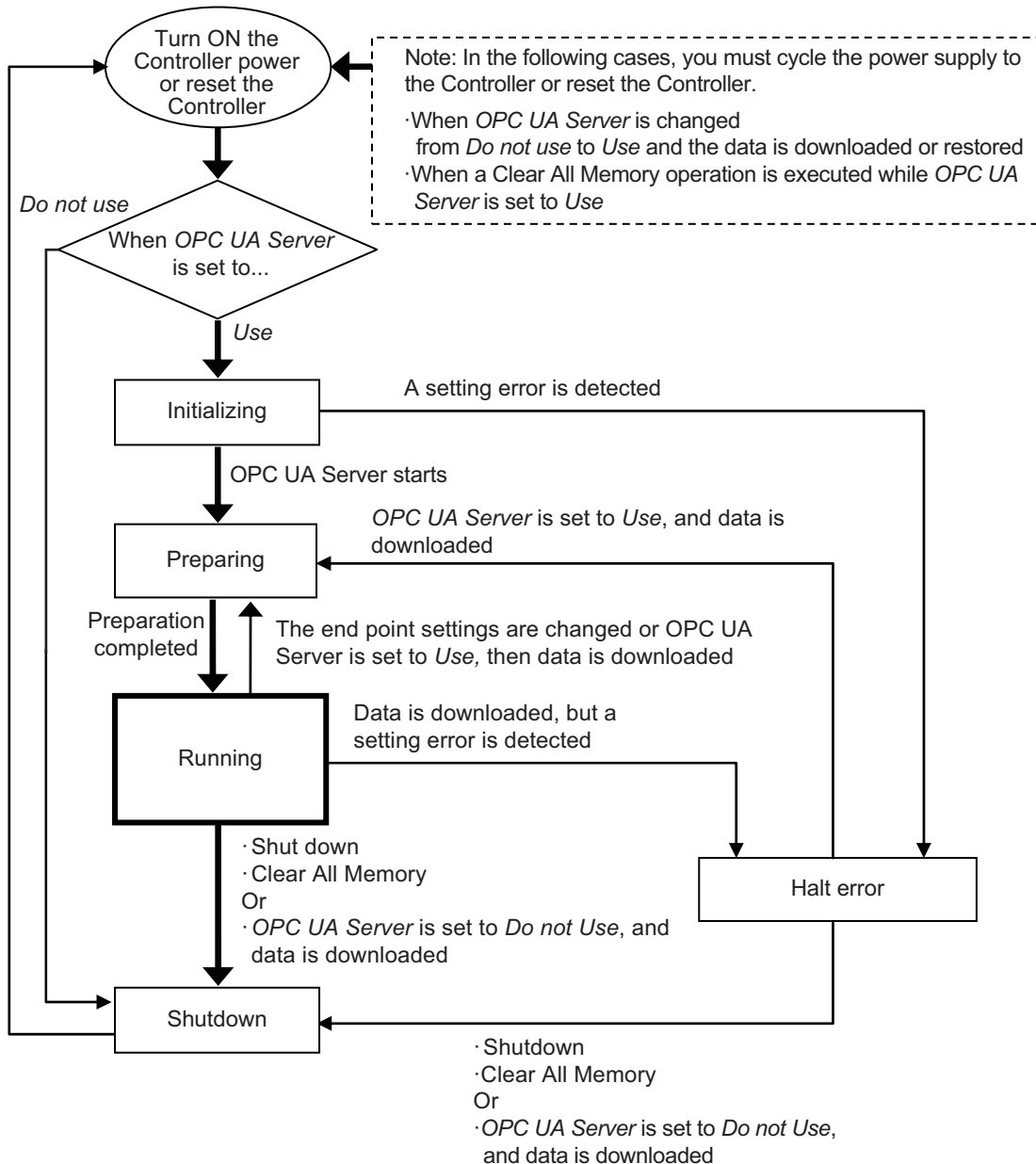

- If the OPC UA server is set to *Use* after the Controller power is turned ON^{*1}, the OPC UA Server enters the *Initializing* state. When the initialization process is complete, the OPC UA Server enters the *Preparing* state, then it shifts to the *Running* state after the completion of preparation.
- In the *Running* state, if the OPC UA Server is shutdown^{*2}, or if OPC UA server is set to *Do not Use* and data is downloaded, the OPC UA Server shifts to the *Shutdown* state.

*1. In the following cases, you must cycle the power supply to the Controller or reset the Controller.

- When OPC UA Server is changed from *Do not use* (setting in the CPU Unit) to *Use* and the data is downloaded or restored*
 - * It includes both the Restore operation executed from the SD Memory Card and the Restore operation executed from the Sysmac Studio.
- When a Clear All Memory operation is executed while OPC UA Server is set to *Use* (setting in the CPU Unit)

*2. When shutdown of the OPC UA Server is instructed from the Sysmac Studio, or when the OPCUA_Shutdown (Shutdown OPC UA Function) instruction is executed.

The details of each status are given below.

Status	Description	Remarks
Initializing	This is the status in which the initial processing of the OPC UA Server is executed.	The OPC UA server settings are read, and each function or monitor is initialized.
Preparing	This is the status in which the OPC UA Server is prepared.	The Controller shifts to this status when the OPC UA Server is used. Configuration of the end point and configuration of the address space (variables to be published) is performed in this status. This is the status in which requests from the OPC UA client cannot be accepted.
Running	This is the status in which the OPC UA Server is running.	The Controller shifts to this status when the configuration of the OPC UA Server is completed. This is the status in which requests from the OPC UA client can be accepted.
Halt error	This is the status in which the OPC UA Server is stopped due to a setting error.	The Controller shifts to this status when a setting error is detected during initialization, or when a download is executed during operation, and a setting error exists in the data.
Shutdown	This is the state while the OPC UA Server is processing to shut down, or when the OPC UA Server has shutdown.	The Controller shifts to this state in the following cases: <ul style="list-style-type: none"> • When shutdown of the OPC UA Server is instructed from the Sysmac Studio, or when the OPCUA_Shutdown (Shutdown OPC UA Function) instruction is executed • OPC UA Server is set to <i>Do not Use</i>, and data is downloaded After the shutdown processing of the OPC UA Server is completed, the user can safely turn OFF the power supply to the Controller. The OPC UA Server cannot be started until you cycle the power supply to the Controller or reset the Controller.

4-2-5 Conditions for Reconfiguring the OPC UA Server

The OPC UA Server is reconfigured if the following changes are made while the OPC UA Server is running.

- When synchronization (download) is executed
- When the restore operation is executed
- When the IP address of the built-in EtherNet/IP port is changed
- When the server certificate is regenerated
- When the security settings are updated



Additional Information

Even if a network-published variable is added by online editing while the OPC UA Server is running, the OPC UA Server is not reconfigured, and the network-published variable is added to the existing address space. In that case, OPC UA clients can access to the variable that you have added.

5

Security Function of OPC UA Server

This section describes the security function of the OPC UA Server.

5-1	Details of the Connection Authentication Function of the OPC UA Server	5-2
5-1-1	Application Authentication	5-2
5-1-2	User Authentication	5-5
5-1-3	Role Function	5-6
5-2	Details of the Message Security Function	5-9
5-2-1	Signature and Encryption	5-9
5-2-2	OPC UA Security Mode and Policy	5-9

5-1 Details of the Connection Authentication Function of the OPC UA Server

This section describes the following two stages of connection functions in detail with regard to the connection authentication function of the OPC UA Server.

Function	Description
Application authentication	Authentication of applications between the OPC UA server and OPC UA client
User authentication	Authentication of the user that operates the client applications of the OPC UA

5-1-1 Application Authentication

The OPC UA server and the OPC UA client authenticate each other's identity by exchanging mutual digital certificates (hereinafter, called *certificates*). This is called *Application authentication*.

In application authentication, the certificates supported by the OPC UA server and the OPC UA client are X.509-standard certificates.

The certificates supported by the OPC UA Server are of the following three types:

Certificate	Description
Server certificate	This is a certificate for certifying an OPC UA server. In the case of an OPC UA server, it is a self-signed certificate.
Client certificate	This is a certificate for certifying the OPC UA client. Both self-signed client certificates and CA-signed client certificates can be used.
CA certificate and Certificate Revocation List	In the case of a CA-signed client certificate, this certificate is used to authenticate the certificate chain.

In the OPC UA Server, the following functions are enabled for each certificate:

Certificate	Function
Server certificate	<ul style="list-style-type: none"> • Generation (automatic generation or manual regeneration^{*1}) of the server certificate (self-signed certificate) • Export of the server certificate from the CPU Unit^{*1} • Advance expiration notice of the server certificate, and notification of expiry
Client certificate	<ul style="list-style-type: none"> • Authentication of the client certificate during a connection^{*1} • Addition of the client certificate (transfer to the CPU Unit)^{*1} • Trust or reject setting of the client certificate^{*1} • Notification of expiry of client certificate
CA certificate and Certificate Revocation List	Used only in the case of a CA-signed client certificate. For details, refer to A-3 <i>When CA-signed Client Certificates Supported</i> on page A-14.

*1. This operation can be performed only by the *Administrator* in the operation authority verification settings of the Sysmac Studio.

For details on each operation method from the Sysmac Studio, refer to 3-2-5 *Setting and Displaying the Certificate* on page 3-12.

Server Certificate

In the OPC UA Server, the following functions are enabled for the server certificate.

● Generation of the Server Certificate (Self-signed Certificate)

The server certificate can be generated by any of the following methods. Each of these methods is for a self-signed certificate.

- Automatic generation

If a server certificate does not exist in the CPU Unit when the OPC UA Server is started, the server certificate is automatically generated.

The contents of the server certificate that is automatically generated are as follows:

Category	Item ^{*1}	Description
Basic information	Issued to	NxOpcUaServer@[IPAddress]
	Issued by	[IPAddress] is the IP address of the built-in EtherNet/IP port at the time of automatic generation.
	Valid from	The server certificate is valid from the date and time of automatic generation up to the date and time twenty years from the start date and time
Detailed information	Version	Version information of the certificate
	Serial number	Unique to each certificate
	Signature algorithm	Algorithm of the signature added to the certificate.
	Issuer	CN=NxOpcUaServer@[IPAddress];, O=Omron Corporation, L=Kyoto, S=Kyoto, C=JP [IPAddress] is the IP address of the built-in EtherNet/IP port at the time of automatic generation.
	Valid from	Date and time of automatic generation
	Valid to	Date and time twenty years from the date and time of automatic generation
	Subject	Same as the issuer
	Public key	Public key of the applicant and its types.
	Thumbprint	Message digest of the CA.
	Detailed Text Box	Each element of the issuer is displayed in a new line.

*1. For the meaning of each item, refer to X.509.

- Manual regeneration

By setting the DN (Distinguished Name) information and the valid period of the server certificate, the server certificate in the CPU Unit can also be manually regenerated.

This function is executed when it is necessary to recreate the server certificate, for example, when the following events occur:

Server Certificate Mismatch (event code: 15020000 hex)

Server Certificate Expired (event code: 35D10000 hex)

Server Certificate Expiration Notice (event code: 35D20000 hex)

Note that regeneration of the server certificate can be executed only by the *Administrator* set as the operation authority.



Precautions for Correct Use

When you download to the CPU Unit a project for which **OPC UA Server** is set to *Use* in the OPC UA Settings, and then cycle the power supply to the Controller, the server certificate is automatically generated by the IP address of the built-in EtherNet/IP port at that time. Thereafter, when you change the IP address of the built-in EtherNet/IP port, the IP address of the built-in EtherNet/IP port and the IP address of the server certificate do not match. Therefore, a *Server Certificate Mismatch* event (event code: 15020000 hex) occurs. In that case, manually regenerate the server certificate, or set the IP address back to the original address.

● Export of the Server Certificate from the CPU Unit

Export the server certificate in the CPU Unit.

This function is executed in cases where the OPC UA client side requires the server certificate before connecting to the OPC UA server.

Note that export of the server certificate can be executed only by the *Administrator* set as the operation authority.

● Advance Expiration Notice of the Server Certificate, and Notification of Expiry

The CPU Unit performs a notification 31 days before the expiry of the server certificate, and also when the server certificate expires.

The notification is recorded in the event log and the Execution Log.

Client Certificate

A self-signed client certificate is described below.

For details on using a CA-signed client certificate, refer to *A-3 When CA-signed Client Certificates Supported* on page A-14.

In the OPC UA Server, the following functions are enabled for the client certificate.

● Authentication of the Client Certificate during a Connection

The OPC UA Server compares the client certificate that is sent during a connection from the OPC UA client, and the client certificate in the Trusted Certificate List that is set from the Sysmac Studio, and allows the connection only if the client certificate is set in advance in the Trusted Certificate List.

If the client certificate does not exist, the OPC UA Server saves the client certificate in the Rejected Certificate List and rejects the connection.

The client certificate is saved in the following locations in the CPU Unit. Each of these locations is set from the Sysmac Studio.

Save location	Description
Trusted Certificate List	This is the location where the certificates of the OPC UA client that are allowed a connection are placed.
Rejected Certificate List	This is the location where the certificates of the OPC UA client that are rejected a connection are placed.

● Addition of the Client Certificate (Transfer to the CPU Unit)

This function is executed in cases where the OPC UA Server requires the client certificate before connecting to the OPC UA client.

Note that addition (transfer) of the client certificate to the CPU Unit can be executed only by the *Administrator* set as the operation authority.

● Automatic Addition of the Client Certificate to the Rejected Certificate List

In the following case, the CPU Unit automatically adds the client certificate of the OPC UA client to the Rejected Certificate List.

- When the OPC UA client establishes a connection with the OPC UA Server, and when the OPC UA client does not exist in the Trusted Certificate List in the CPU Unit

● Trust or Reject Setting of the Client Certificate

By placing the Sysmac Studio online with the CPU Unit, and moving the client certificate of the CPU Unit as described below, you can set whether to trust or reject a connection.

Note that the trust or reject settings of the client certificate can be made only by the *Administrator* set as the operation authority.

- Settings for allowing a connection

The client certificate is moved from the Rejected Certificate List to the Trusted Certificate.

● Notification of Expiry of Client Certificate

The CPU Unit performs a notification when the certificate in the Trusted Certificate List expires.

The notification is recorded in the event log and the Execution Log.

5-1-2 User Authentication

The OPC UA Server authenticates the identity of the user that operates the client applications of the OPC UA by either of the following methods.

- Authentication based on user name and password
- Authentication based on Anonymous

This is called *User authentication*.

The OPC UA Server supports *Allow access to all* in a fixed manner as the user access authority of the OPC UA.

For details on the operation method from the Sysmac Studio, refer to *Adding a User Name* on page 3-28 and *Changing the Password* on page 3-29 in 3-2-6 *Security Settings* on page 3-24.

Authentication Based on User Name and Password

Only users for whom the user name and password are matching can connect to the OPC UA Server. Note that registration, deletion, and change of the user name and password can be executed only by the *Administrator* set as the operation authority.

Authentication Based on Anonymous

It is also possible to not perform authentication of the identity of the user that operates the client applications of the OPC UA by the user name and password.

If you log in as Anonymous, your authority is equivalent to if you were assigned for the role of Observer.



Version Information

For the unit versions of the following CPU Units, if you log in as Anonymous, you have the same authority as the Administrator.

NJ501-1□□00: Version earlier than 1.62

NX102-□□□□: Version earlier than 1.63

NX502-1□□00: Version earlier than 1.63

NX701-1□□□: Version earlier than 1.34



Additional Information

If the OPC UA communications cannot be performed normally, check the consistency of anonymous login setting between the Controller and OPC UA client. For details on how to make the settings, refer to *3-2-6 Security Settings* on page 3-24.

5-1-3 Role Function

The role function can manage access permissions to nodes based on the role of user.

A user can access a node only if the role assigned to the node, such as a namespace or an instance in a user-defined function block, is also assigned to the user.

For example, if *Operator* is assigned to the roles of node Abort and node Clear, the nodes are as follows.

- If you connect with a username whose role is *Operator*

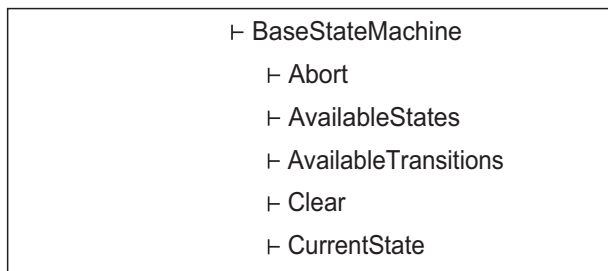

- If you connect with a username whose role is *Observer*

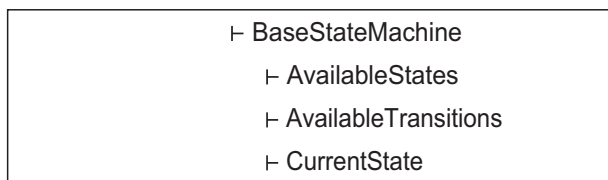

For details on the operation method from the Sysmac Studio, refer to *Setting Roles to User Names* on page 3-28 and *Setting Roles for Nodes* on page 3-30 in *3-2-6 Security Settings* on page 3-24.



Version Information

The role function can be set for the unit versions of the following CPU Units.

NJ501-1□□00: Version 1.62 or later

NX102-□□□□: Version 1.64 or later

NX502-1□□00: Version 1.64 or later

NX701-1□□□: Version 1.34 or later

Setting Target of Roles

Set roles for user name and nodes.

Setting target	Description
User name	Set which roles are assigned to the user name.
Nodes <ul style="list-style-type: none"> • Namespace • Instances in user-defined function blocks 	Set the user name to which the role is assigned to allow access to which node.



Precautions for Correct Use

Roles cannot be set for global variables. All users can access to published global variables, regardless of the role assigned to the username.

Types of Role

The following types of roles can be set.

Role	Well Known Role of the corresponding OPC UA
Observer	AuthenticatedUser Observe
Operator	Operator
Maintainer	Supervisor
Designer	Engineer
Administrator	ConfigureAdmin SecurityAdmin

The following table shows the accessible nodes for roles assigned to user names.

(Possible.: Accessible/Not Possible.: Not Accessible)

Roles assigned to user names	Roles assigned to nodes				
	Observer	Operator	Maintainer	Designer	Administrator
Observer	Possible.	Not possible.	Not possible.	Not possible.	Not possible.
Operator	Possible.	Possible.	Not possible.	Not possible.	Not possible.
Maintainer	Possible.	Possible.	Possible.	Not possible.	Not possible.
Designer	Possible.	Possible.	Possible.	Possible.	Not possible.
Administrator	Possible.	Possible.	Possible.	Possible.	Possible.

The following table shows the permissions that can be performed with the OPC UA specifications for roles assigned to user names.

(Possible.: Can be executed/Not possible.: Cannot be executed)

Roles assigned to user names	Permissions that can be performed with the OPC UA specifications			
	Browse function	Read function	Write function	Method function
Observer	Possible.	Possible.	Not possible.	Not possible.
Operator	Possible.	Possible.	Possible.	Possible.
Maintainer	Possible.	Possible.	Possible.	Possible.
Designer	Possible.	Possible.	Possible.	Possible.
Administrator	Possible.	Possible.	Possible.	Possible.



Additional Information

If you log in to the OPC UA function as Anonymous, your authority is equivalent to if you were assigned the role of Observer.

5-2 Details of the Message Security Function

This section describes the details of the message security function in the OPC UA communications. In the OPC UA Server, the signature and encryption of messages allowed by the server is set by a security policy.

5-2-1 Signature and Encryption

- Signature refers to signature information that is added and encrypted to assure the validity of certificates and messages.
- Encryption refers to conversion of a message into a code whose meaning is not understood by a particular method (algorithm) during the transmission and reception of the message so that it is not stolen or modified by a third person during communications.

5-2-2 OPC UA Security Mode and Policy

This is a security mechanism for messages that are allowed during exchange with the OPC UA client. The signature for the messages, the encryption of messages, and the algorithm for the signature and encryption are set.

Place the Sysmac Studio online with the CPU Unit, and make the settings as shown below. In the Multiview Explorer, right-click **OPC UA Server Settings** under **Configurations and Setup - OPC UA Settings**, and then select **Security Settings**. Under **Security Policy**, specify the OPC UA security mode and policy to be allowed from the following. You can select multiple items.

OPC UA security modes and policies that can be selected	Description	
None	Neither signature nor encryption are required. Not recommended for security reasons. *1	
Sign - Basic128Rsa15	A signature is required and the integrity (measures against modifications, etc.) of data is secured.	Basic128Rsa15 is supported as the algorithm of the signature. Not recommended for security reasons. *2
Sign - Basic256		Basic256 is supported as the algorithm of the signature. Not recommended for security reasons. *2
Sign - Basic256Sha256		Basic256Sha256 is supported as the algorithm of the signature.
Sign - Aes128Sha256RsaOaep		Aes128Sha256RsaOaep is supported as the algorithm of the signature. *3
Sign - Aes256Sha256RsaPss		Aes256Sha256RsaPss is supported as the algorithm of the signature. *3

OPC UA security modes and policies that can be selected	Description	
SignAndEncrypt - Basic128Rsa15	A signature and encryption are required, and the integrity (measures against modifications, etc.) and reliability (measures against wiretapping, etc.) of data are secured.	Basic128Rsa15 is supported as the algorithm of the signature and encryption. Not recommended for security reasons. *2
SignAndEncrypt - Basic256		Basic256 is supported as the algorithm of the signature and encryption. Not recommended for security reasons. *2
SignAndEncrypt - Basic256Sha256		Basic256Sha256 is supported as the algorithm of the signature and encryption.
SignAndEncrypt - Aes128Sha256RsaOaep		Aes128Sha256RsaOaep is supported as the algorithm of the signature and encryption. *3
SignAndEncrypt - Aes256Sha256RsaPss		Aes256Sha256RsaPss is supported as the algorithm of the signature and encryption. *3

*1. For the unit versions of the following CPU Units, the factory default setting is disabled.

NJ501-1□□00: Version 1.48 or later
 NX102-□□□□: Version 1.48 or later
 NX502-1□□00: Version 1.60 or later
 NX701-1□□□: Version 1.28 or later

*2. For the unit versions of the following CPU Units, the factory default setting is disabled.

NJ501-1□□00: Version 1.62 or later
 NX102-□□□□: Version 1.64 or later
 NX502-1□□00: Version 1.64 or later
 NX701-1□□□: Version 1.34 or later

*3. You can select it for the unit versions of the following CPU Units.

NJ501-1□□00: Version 1.64 or later
 NX102-□□□□: Version 1.64 or later
 NX502-1□□00: Version 1.64 or later
 NX701-1□□□: Version 1.35 or later

For details on the OPC UA security mode and policy, refer to the OPC UA specifications.



Precautions for Correct Use

When you take security into consideration, be sure to clear *None*, *Sign - Basic128Rsa15*, *SignAndEncrypt - Basic128Rsa15*, and *SignAndEncrypt - Basic256* under **Security Policy**.



Additional Information

If the OPC UA communications cannot be performed normally, check the consistency of security policy setting between the Controller and OPC UA client. For details on how to make the settings, refer to 3-2-6 *Security Settings* on page 3-24.

6

Connecting from the OPC UA Client and Reading/Writing Variables

This section describes establishing a connection from the OPC UA client and reading/writing the variables of the OPC UA Server.

6-1	Connecting from the OPC UA Client	6-2
6-1-1	Specifying the URL of the Target OPC UA Server	6-2
6-1-2	Connecting to the Target OPC UA Server.....	6-2
6-2	Reading/Writing Variables from the OPC UA Client	6-3
6-2-1	Address Space of the NJ/NX-series Controller	6-3
6-2-2	Reading/Writing the Variables of the CPU Unit	6-5

6-1 Connecting from the OPC UA Client

This section presents an overview of connecting to the OPC UA Server from the OPC UA client. Execute the following on the OPC UA server from the OPC UA client.

- Specify the URL of the target OPC UA Server
- Connect to the target OPC UA Server

6-1-1 Specifying the URL of the Target OPC UA Server

Enter `opc.tcp://[IP address]:[Port No.]` as the URL, and specify the end point of the target OPC UA Server.

As for the URL, enter the URL set in **OPC UA Server Settings - End Point** under **Configurations and Setup - OPC UA Settings** in the Multiview Explorer of the Sysmac Studio.
(By default, `opc.tcp://192.168.250.1:4840/` is set.)

6-1-2 Connecting to the Target OPC UA Server

Set the security policy within the range permitted at the server side*¹.

For details on OPC UA security modes and policies that can be selected, refer to *5-2 Details of the Message Security Function* on page 5-9.

Select a user authentication method within the permissible range at the server side.

If you select a method based on the user name and password, enter the user name and password*².

*1. The range of permitted security policies depends on the setting of **Security Policy** under **Security Settings**, which is displayed when **OPC UA Server Settings** is right-clicked under **Configurations and Setup - OPC UA Settings** in the Multiview Explorer of the Sysmac Studio.

*2. Set from **OPC UA Server Settings - Security Settings** under **Configurations and Setup - OPC UA Settings** in the Multiview Explorer of the Sysmac Studio.



Additional Information

If a connection cannot be established, check for a connection error at the OPC UA client, and then check the settings, etc.

As for the status at the server side, connect the Sysmac Studio to the NJ/NX-series Controller, check for a certificate error, connection rejection, etc. from the event log, and then take necessary actions. For details, refer to the *NJ/NX-series Troubleshooting Manual (Cat. No. W503)*. Or, check the contents of the Execution Log, and take necessary actions. For details, refer to *Section 7 Execution Log Functions* on page 7-1.

6-2 Reading/Writing Variables from the OPC UA Client

This section describes the address space of the NJ/NX-series Controller visible to the OPC UA client, and also reading/writing the variables of the CPU Unit from the OPC UA client.

6-2-1 Address Space of the NJ/NX-series Controller

The address space of the NJ/NX-series Controller is published as described below.

Address space of the NJ/NX-series Controller that can be referenced by the client

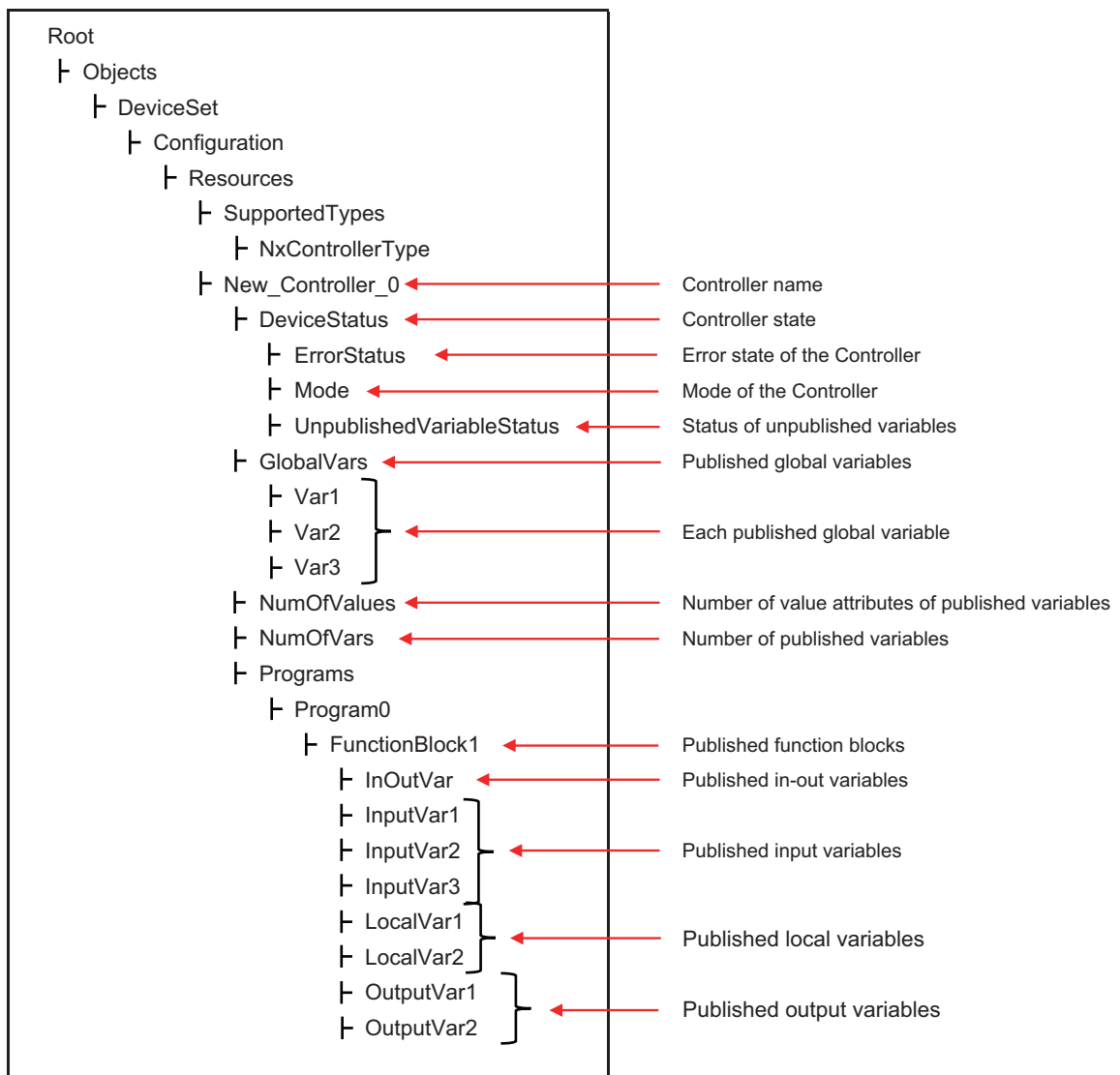

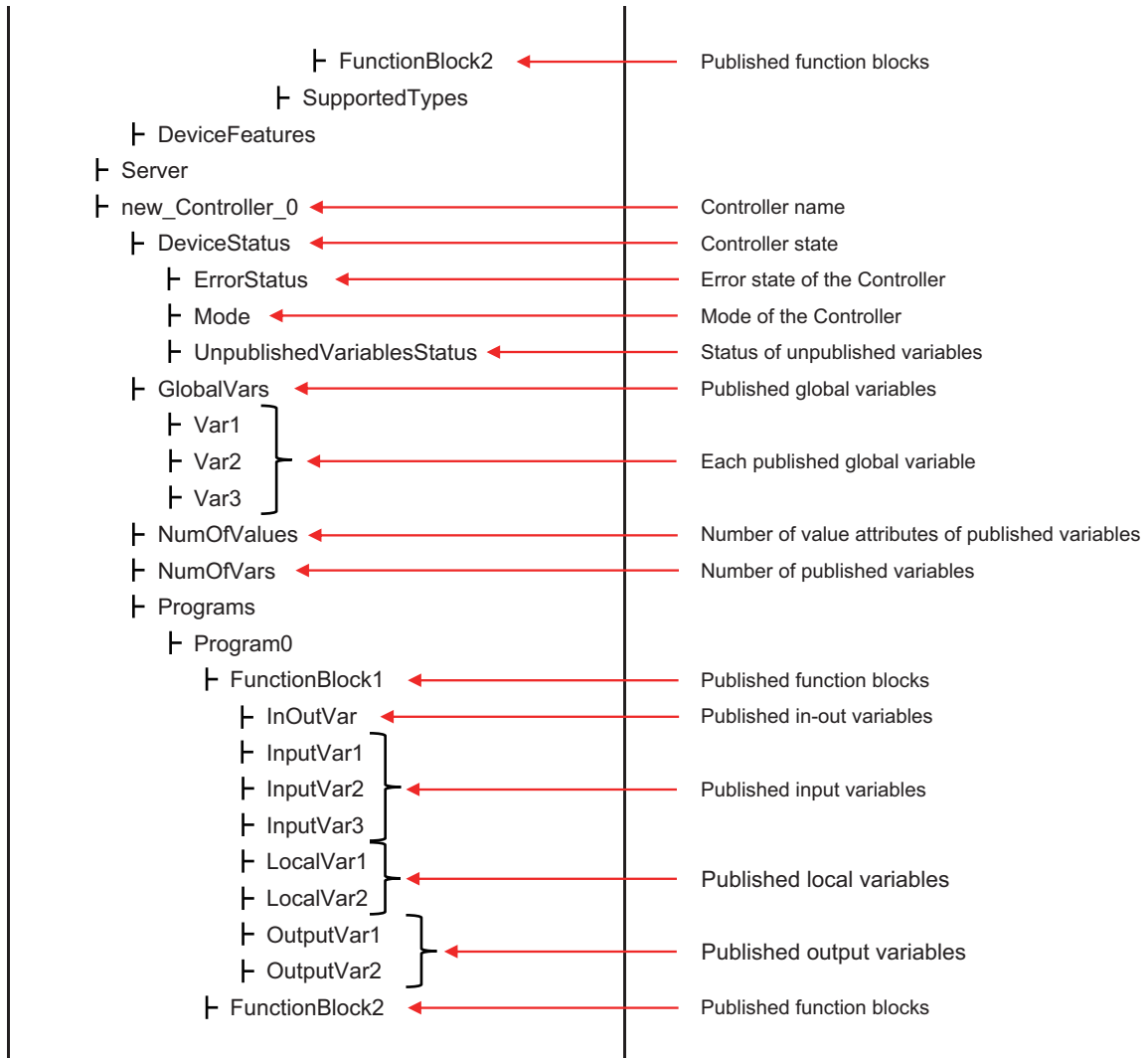

Controller Name

The Controller name set in the Sysmac Studio is displayed as the folder name.

Controller State

The Controller state is displayed as shown below under *DeviceState*.

Properties	Description	Values
ErrorState	Indicates the error state of the Controller.	<ul style="list-style-type: none"> NoError: Normal MajorFault: Major fault ContinuousError: Partial fault or minor fault
Mode	Indicates the mode of the Controller.	<ul style="list-style-type: none"> RUN: RUN mode PROGRAM: PROGRAM mode

Properties	Description	Values
UnpublishedVariablesStatus	Indicates the status of unpublished variables.	The following bits change to TRUE when a relevant error occurs. Bit 00: Number of Public Variables Exceeded Bit 01: Number of Published Value Attributes Exceeded Bit 02: The number of user-defined data types has been exceeded Bit 03: Variables of an unsupported data type exist Bit 04 to bit 15: Reserved (The value is FALSE)

Published Function Blocks

The published user-defined function blocks and the variables used in the function blocks are displayed.



Version Information

The user-defined function blocks and variables used in the function blocks can be published with the unit versions of the following CPU Units.

NJ501-1□□00: Version 1.62 or later

NX102-□□□□: Version 1.64 or later

NX502-1□□00: Version 1.64 or later

NX701-1□□□: Version 1.34 or later

Number of Published Variables

The number of variables published under GlovalVars of the OPC UA Server is displayed. This will allow you to check if the number of variables exceeds the upper limit.

Number of Value Attributes of Published Variables

The number of value attributes in the OPC UA attribute of the variables published under GlovalVars of the OPC UA Server is displayed. As a result, it is possible to check if the number of value attributes of variables exceeds the upper limit.



Version Information

There are no restrictions on the number of value attributes of variables *NunOfValues* with the unit versions of the following CPU Units. Since the number of value attributes of variables is included in *NumOfVars*, use *NumOfVars*.

NJ501-1□□00: Version 1.62 or later

NX102-□□□□: Version 1.64 or later

NX502-1□□00: Version 1.64 or later

NX701-1□□□: Version 1.34 or later

6-2-2 Reading/Writing the Variables of the CPU Unit

With a read/write request from the OPC UA client, the following variables can be read from or written to the CPU Unit via the target OPC UA Server function.

- Global variables
- Input variables, output variables, in-out variables, and internal variables in user-defined function blocks
- Input variables, output variables, in-out variables, and internal variables in function blocks associated with the companion specifications



Version Information

The variables in user-defined function blocks and function blocks associated with the companion specifications can be read and written with the unit versions of the following CPU Units.

NJ501-1□□00: Version 1.62 or later

NX102-□□□□: Version 1.64 or later

NX502-1□□00: Version 1.64 or later

NX701-1□□□: Version 1.34 or later

Data Type of Variables Published to the OPC UA Client

- Basic data type

The basic data types of the CPU Unit correspond to the OPC UA data types, as shown below.

Controller data type	OPC UA data type	Description of OPC UA data type
BOOL	Boolean	A value indicating two states represented by an 8-bit value.
SINT	SByte	8-bit signed integer
USINT BYTE	Byte	8-bit unsigned integer
INT	Int16	16-bit signed integer
UINT WORD	UInt16	16-bit unsigned integer
DINT	Int32	32-bit signed integer
UDINT DWORD	UInt32	32-bit unsigned integer
LINT	Int64	64-bit signed integer
ULINT LWORD	UInt64	64-bit unsigned integer
REAL	Float	IEEE-754 single-precision floating-point value
TIME LREAL	Double	IEEE-754 double-precision floating-point value
STRING	String	UTF-8 string ending in NULL
DATE_AND_TIME DATE TIME_OF_DAY	DateTime	Date and time 64 bits. 100-ns time from January 1, 1601

Note Conforms to PLCopen OPC UA Information Model 1.00 Specifications.

- Array

As for the arrays of the CPU Unit, as shown below, an entire array variable is published as one node.

One-dimensional or multi-dimensional arrays can be specified.

Example) ArrayVar1, ArrayVar2, and ArrayVar3 are array variables.

The arrays can be manipulated differently depending on the node setting. For details on node setting, refer to *Node Setting* on page 3-8.

To read or write to an entire array variable, select **Do not expand** in **Node Setting**.

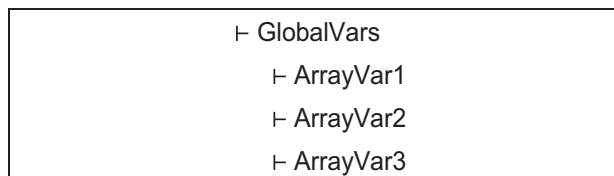

Reading and writing between the OPC UA server and the OPC UA client is performed by the entire array variable.



Additional Information

If the OPC UA client has the functions to interpret the type information of the array and to display array element, the array element can be displayed.

To read or write to an entire array variable or each element, select **Expand** in **Node Setting**.

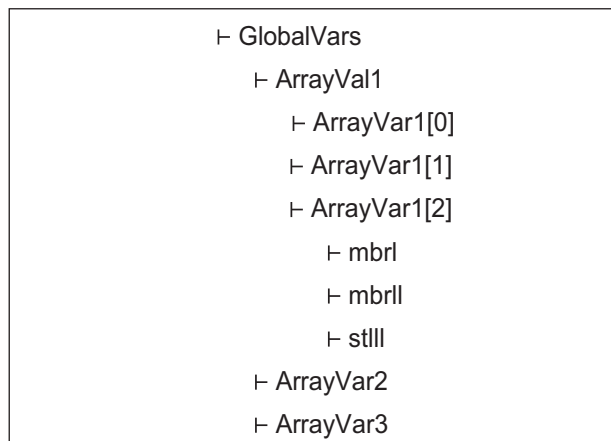

Reading and writing between the OPC UA server and the OPC UA client is performed by the entire array variable or each array element.

- Structure

As for the structures of the CPU Unit, as shown below, an entire structure variable is published as one node.

Example) StructVar1, StructVar2, and StructVar3 are structure data type variables.

mem1, mem2, mem3, and still are members of each of above structures.

The structure can be manipulated differently depending on the node setting. For details on node setting, refer to *Node Setting* on page 3-8.

To read or write to an entire structure variable, select **Do not expand** in **Node Setting**.

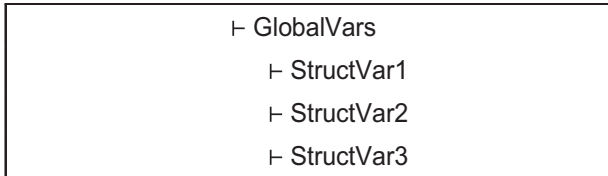

The entire structure variable is read and written between the OPC UA server and the OPC UA client.



Additional Information

If the OPC UA client has the functions to interpret the type information of the structure and to display the member levels in the structure, the member levels in the structure can be displayed.

To read or write to an entire structure variable or each member, select **Expand** in **Node Setting**.

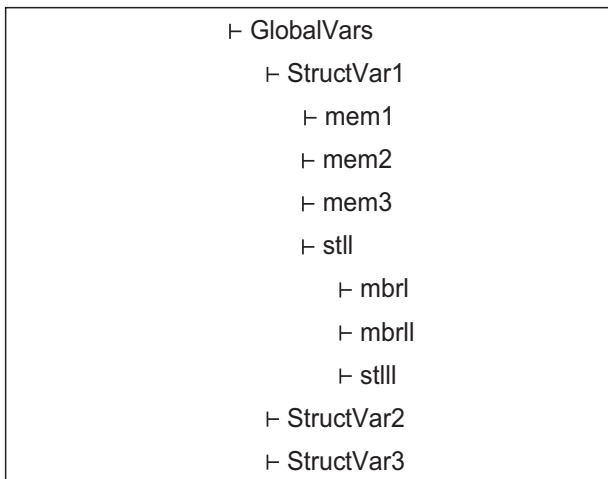

The entire structure variable or each structure member can be read or written between the OPC UA server and the OPC UA client.

- Enumerated type
The enumerated type of the CPU Unit is published as the Int32 type.
The enumerated type is handled as the DINT type in the CPU Unit.



Additional Information

If the OPC UA client has the functions to interpret the type information of the enumerated type and to display it as the enumerated type, the enumerated type can be displayed.

Reading/Writing the Global Variables of the CPU Unit

The OPC UA Server function publishes those global variables to the OPC UA client in which the network publish attribute is *Publish Only*, *Output*, or *Input*. Note that system-defined variables cannot be published.

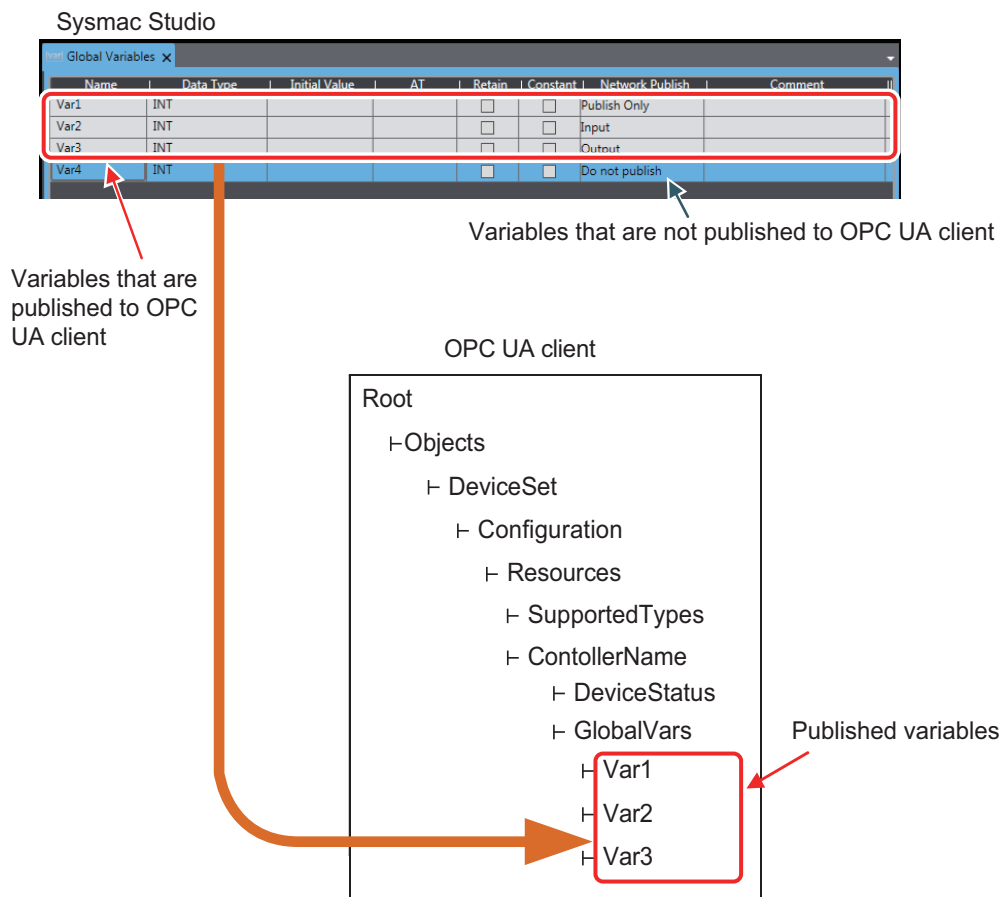

● **Settings of Global Variable Attributes**

Global variable attribute	Setting of the variable on the OPC UA Server
Name	Set to <i>DisplayName</i> and <i>BrowseName</i> .
Data type	Refer to <i>Data Type of Variables Published to the OPC UA Client</i> on page 6-6.
Initial value	---
AT specification	---
Retained	---
Constant	When this is set to <i>ON</i> , <i>AccessLevel</i> is set to <i>CurrentRead</i> (Set to <i>ReadOnly</i>). When this is set to <i>OFF</i> , <i>AccessLevel</i> is set to <i>CurrentRead</i> , <i>CurrentWrite</i> .
Network Publish	<i>Do not publish</i> indicates that the variable is not published to the OPC UA client. <i>Publish Only</i> , <i>Output</i> , and <i>Input</i> indicate that the variable is published to the OPC UA client. Both reading and writing are possible. However, even if registered as a network-published variable, there are restrictions on variables to be published to OPC UA clients. For details, refer to <i>Restrictions on Publishing to the OPC UA Client</i> on page 6-12.
Comment	---

● **Reading/Writing Global Variables from the OPC UA Client**

The OPC UA client can perform reading/writing of the global variables of the CPU Unit serving as the OPC UA Server.

Whether the OPC UA client can read/write global variables depends on the setting value of the *Network Publish* attribute, as shown below.

Setting value of <i>Network Publish</i> attribute of the global variable	Reading/writing variables from the OPC UA client
<i>Do not publish</i>	Both reading and writing are not possible.
<i>Publish Only, Input, or Output</i>	Both reading and writing are possible.

Reading/Writing Variables in User-defined Function Blocks of CPU Unit

The input variables, output variables, in-out variables, and internal variables in user-defined function blocks can be published to the OPC UA client.



Version Information

The variables in user-defined function blocks can be published to OPC UA client with the unit versions of the following CPU Units.

NJ501-1□□00: Version 1.62 or later
 NX102-□□□□: Version 1.64 or later
 NX502-1□□00: Version 1.64 or later
 NX701-1□□□: Version 1.34 or later



Precautions for Correct Use

To obtain values for in-out variables correctly, make sure that an instance of the function block is executed every task from when operation is started.

Settings of Variable Attributes in User-defined Function Blocks

Variable attribute	Setting of the variable on the OPC UA Server function
Name	Set to <i>DisplayName</i> and <i>BrowseName</i> .
Data type	Reading and writing the variables of the CPU Unit. Refer to <i>Data Type of Variables Published to the OPC UA Client</i> on page 6-6 for details.
Edge	---
Initial value	---
AT specification	---
Retained	---
Constant	When this is set to <i>ON</i> , <i>AccessLevel</i> is set to <i>CurrentRead</i> (Set to <i>ReadOnly</i>). *1 When this is set to <i>OFF</i> , <i>AccessLevel</i> is set to <i>CurrentRead</i> , <i>CurrentWrite</i> . *1
Comment	---

*1. Output variables are excluded.

Reading/Writing Variables in User-defined Function Blocks from OPC UA Client

The OPC UA client can read and write input variables, output variables, in-out variables, and internal variables in the user-defined function blocks of the CPU Unit with the OPC UA Server function. For variables in user-defined function blocks, the following specification enables reading and writing of the variables from the OPC UA client.

You can also have more control over reading and writing variables with the role function. Refer to *5-1-3 Role Function* on page 5-6 for details.

Specification Method	Description
Specify Namespace	Specifies the namespace defined in the POU properties of the function block. The variables generated from types that belong to the specified namespace are published.
Specify user-defined function block instances	Specifies the variables of the user-defined function block instances to be published. *1 Variables of the specified function block instances are published.

*1. The function block instance array cannot be specified. This also includes when the array element of the function block instance array is individually specified.



Additional Information

No error occurs if the specified namespace is duplicated with the namespace set in the specified instance.

● **Publishing Function Block Instances Individually**

If a function block instance exists in an internal variable of a function block, you can make the public setting individually.

Here, the external function block is called "parent FB", and the internal function block is called "child FB".

The relationship for public settings between the parent FB and the child FB is as follows.

Network Publishing Settings		Publishing on the OPC UA server	
Parent FB	Child FB	Parent FB	Child FB
Set	Do not set	Published	Not published*1
	Set	Published	Published
Do not set	Do not set	Not published	Not published
	Set	Not published	Published

*1. As an exception, if the child FB does not have a namespace, it is published as if it was the parent FB.

Reading/Writing Variables in Function Blocks Associated with Companion Specifications

The variables in the function blocks associated with the companion specifications can be published to the OPC UA client.



Version Information

The unit versions of CPU Units that support the companion specifications are as follows.
 NJ501-1□00: Version 1.62 or later
 NX102-□□□□: Version 1.64 or later
 NX502-1□00: Version 1.64 or later
 NX701-1□□□: Version 1.34 or later

● Mapping of Attributes of Variables in Function Block to Companion Specifications

Follow the specifications of the Sysmac Library corresponding to the companion specifications. Refer to the *Sysmac Library for OPC UA PackML Library User's Manual (Cat. No. W638)* for details.

● Reading/Writing Variables from OPC UA Clients

The OPC UA client can read and write input variables, output variables, in-out variables, and internal variables in the function blocks associated with the companion specifications for the OPC UA Server function of the CPU Unit.

You can also have more control over reading and writing variables with the role function. Refer to *5-1-3 Role Function* on page 5-6 for details.

Specification Method	Description
Specify Namespace	Specifies the namespace defined in the POU properties of the function block. The variables generated from types that belong to the specified namespace are published.



Precautions for Correct Use

- Even if the companion specifications are implemented in the Sysmac Library, you must specify the namespace if you publish variables for companion specifications.
- You cannot publish namespaces or instances of the Sysmac Library that do not support the companion specifications.

Restrictions on Publishing to the OPC UA Client

Not all variables registered as network-published variables are published to the OPC UA client. The variables published to the OPC UA client are restricted based on the following restrictions. If there are variables that are not published to the OPC UA client, you need to review the network-published variables to make sure that they remain within the following limits.

● Restrictions

The restrictions on public variables in the OPC UA Server are described below.

For All Network-published Variables

Scope of restriction	Item	Description
All network-published variables	Number of public variables ^{*1*2}	10,000 max. ^{*3} The number of public variables includes the number of elements in the array specification and the number of values in the structure.
	Number of value attributes of public variables ^{*4}	There is no limit to the number of value attributes. ^{*5} Since the number of value attributes is included in the number of public variables, the number of public variables is limited.
	Number of structure definitions that can be published ^{*6}	100 max. It does not include the number of structures defined in the companion specifications.

Scope of restriction	Item	Description
	Others	Namespaces or instances in the Sysmac Library that do not support companion specifications cannot be published.

- *1. When structure members are expanded to nodes, the expanded member is newly counted as one node in the number of public variables.
- *2. For NX701-1□□□ CPU Unit with unit version 1.34 or later, the number of public variables is the total of the following.
Number of public variables = (number of variables of basic type) + (number of elements specified by array) + (number of values in structure)
- *3. For NX701-1□□□ CPU Units with unit version 1.34 or later, the maximum number is 100,000.
- *4. The number of value attributes is the total of the following.
Number of value attributes = (number of variables of basic type) + (number of elements specified by array) + (number of values in structure)
- *5. For the unit versions of the following CPU Units, the maximum number is 10,000.
 NJ501-1□□00: Version earlier than 1.62
 NX102-□□□□: Version earlier than 1.63
 NX502-1□□00: Version earlier than 1.63
 NX701-1□□□: Version earlier than 1.34
- *6. Details of *number of structure definitions that can be published* are as follows:
 - Specify the number of definitions. Even if the same definition is used in multiple variables, the number of definitions is not counted up.
 - If the data type of the members of the structure is also a structure, the number of members (that are structures) is also counted.
 - If the data type of the members of the structure is either basic data type or array, the members are not counted.

For Individual Network-published Variables

Scope of restriction	Item	Description
Individual network-published variables	Size of public variable	60 KB ^{*1} max.
	Array specification	<ul style="list-style-type: none"> • There is no limit to the number of elements. ^{*2} Since the number of array elements is included in the number of public variables, the number of public variables is limited. ^{*3*4} • According to the OPC UA specifications, only elements whose element number starts with 0 (zero) can be published. • Instance arrays in user-defined function blocks cannot be published. ^{*5} • Variable-length arrays cannot be published.
	Structure	<ul style="list-style-type: none"> • The maximum number of members per structure type variable^{*6} is 100. • The maximum number of levels is three. It does not include the number of structure levels defined in the companion specifications. • Two-dimensional or higher structure arrays for global variables and structure containing two-dimensional or higher arrays cannot be published. • If the member of the structure is a multidimensional array of basic type, the member will be published as one-dimensional array. • The following structures cannot be published. <ul style="list-style-type: none"> • Multidimensional array specified structure^{*7*8} • Structure containing a multidimensional array as a member^{*8} • Structure containing a multidimensional array specified structure as a structure member^{*9}
	Unions	<ul style="list-style-type: none"> • Cannot be published. • A structure containing union(s) as member(s) cannot be published.
	Reserved words ^{*10}	Global variables, program names, and user-defined data type names with reserved words cannot be published.

*1. For the unit versions of the following CPU Units, the maximum size is 1,024 bytes.

NJ501-1□□00: Version earlier than 1.48
NX102-□□□□□: Version earlier than 1.48
NX701-1□□□□: Version earlier than 1.28

*2. For global variables, the maximum number is 2,048.

*3. For the unit versions of the following CPU Units, the maximum number is 1,024.

NJ501-1□□00: Version earlier than 1.48
NX102-□□□□□: Version earlier than 1.48
NX701-1□□□□: Version earlier than 1.28

*4. For the unit versions of the following CPU Units, the maximum number is 2,048.

NJ501-1□□00: Version earlier than 1.62
NX102-□□□□□: Version earlier than 1.63
NX502-1□□00: Version earlier than 1.63
NX701-1□□□□: Version earlier than 1.34

*5. Publishing variables to specify instances in user-defined function blocks is a function of the following CPU Units:

NJ501-1□□00: Version 1.62 or later

NX102-□□□□: Version 1.64 or later

NX502-1□□0: Version 1.64 or later

NX701-1□□□: Version 1.34 or later

- *6. In the *number of members per structure type variable*, if the data type of the members of the structure is also a structure, the number of subordinate members (that are structures) is not counted as the restrictions are applied.
- *7. The *multidimensional array specified structure* indicates two-dimensional or higher array specifications in which the elements are structures.
- *8. The restriction is applied for the unit versions of the following CPU Units.
 - NJ501-1□□0: Version earlier than 1.62
 - NX102-□□□□: Version earlier than 1.63
 - NX502-1□□0: Version earlier than 1.63
 - NX701-1□□□: Version earlier than 1.34
- *9. The *structure containing a multidimensional array specified structure as a member* indicates a structure type containing two or higher dimensional structure array specifications as a member.
- *10. Refer to *Reserved Words* on page 6-17 for details.

A variable that is not published with the OPC UA Server function due to the above restrictions is not displayed in the OPC UA client even if it is registered as a network-published variable.

● Method of Checking the CPU Unit

When an address space is prepared in the OPC UA Server of the CPU Unit, the above restrictions are checked according to the procedures described below.

- Step 1: The group of network-published variables is sorted in the ascending order of the character code UTF-16 of the variable name.
For example, sorting is done in the order of single-byte numbers (in the order of 0 to 9) -> single byte alphabets (in the order of A to Z) -> double-byte characters. Note that single-byte alphanumeric characters are not case sensitive.
- Step 2: Based on the list of the variables sorted by the variable name, check the variables first in terms of the above restrictions set for all network-published variables, and then in terms of the restrictions set for individual. If they remain within the above restrictions set for all network-published variables as well as the ones set for individual, the variables will be published to OPC UA clients.



Additional Information

Variables specified to be published according to the companion specifications are checked below.

- Published variables are not sorted.
- All variables are published.
- The number of variables specified to be published according to the companion specifications are also counted for the maximum number of restrictions.

● Registering the Check Results

If, as a result of the above checks, variables that are not published to the OPC UA Server are found to exist, the check results are registered in the event log and the Execution Log for each restriction.

- The occurrence information of the unpublished variables is registered in the event log.
- In addition to the occurrence information, detailed information of each published variable is also registered in the Execution Log.

Item	Event log	Execution Log (Category name - Log code (position of log name))	
Number of public variables in all network-published variables	<i>Too Many Public Variables</i> (Event code: 35D30000 hex)	<ul style="list-style-type: none"> Occurrence information: SERVER-0100 (The maximum number of variables that can be published has been exceeded) Information about the number of public variables: SERVER-0110 (Number of OPC UA public variables) 	Detailed information of each published variable: SERVER-0111 (Detailed information of OPC UA public variables)
Number of value attributes of public variables in all network-published variables	<i>Too Many Public Value Attributes</i> (Event code: 35D50000 hex)		
Number of structure definitions that can be published in all network-published variables	<i>Too Many Structure Definitions</i> (Event code: 35D60000 hex)		
Size of public variables of each network-published variable	<i>Unsupported Data Type/Invalid Data</i> (Event code: 35D40000 hex)	<ul style="list-style-type: none"> Occurrence information: SERVER-0101 (Variables containing an unsupported data type or an invalid data) 	
Array specifications of each network-published variable			
Structures of each network-published variable			
Unions of each network-published variable			

- Both the event log and the Execution Log are registered when any of the following operations is performed:
 - When the power is turned ON or when the Controller is reset
 - During a download
 - During a restore operation
 - When a variable added through online editing is subject to the restrictions.

For details on the event log and the Execution Log, refer to the *NJ/NX-series Troubleshooting Manual (Cat. No. W503)* and *7-1-5 Execution Log File Specifications* on page 7-4, respectively.

● Method of Checking Variables Added through Online Editing

If a network-published variable is added through online editing from the Sysmac Studio, the above check operation is performed for the added variable. If the added variable does not exceed any limit, the variable is published to the OPC UA client.

Note that if multiple network-published variables are simultaneously added through online editing, checking is performed according to the above sorting order only for the group of added variables (re-checking of all variables is not performed).



Precautions for Safe Use

Even if a variable is set to Network Publish in the Sysmac Studio, the OPC UA client may not be able to refer to or read/write the variable in some cases depending on the limits set on variables that can be published to the OPC UA client of the OPC UA Server function.

Refer to the event log or Execution Log, and review which variables to be published to the network depending on the cause of occurrence.

**Precautions for Correct Use**

For function block instances that support companion specifications, you cannot add public variables in online editing.

Reserved Words

Reserved words are names that cannot be used within the OPC UA address space used internally by the system.

If reserved words are used, the nodes are not published in the OPC UA address space. A record using reserved words is registered in the execution log and event log.

The following are reserved words.

Reserved word	Subject for which a reserved word is not available		
	Global variable	Program name	User-defined data type name (if a namespace is not specified)
ConfigurationType	Not applicable	Not applicable	Not applicable
DeviceStatus			
NumOfValues			
NumOfVars			
NxConfigurationType			
NxController			
NxControllerType			
NxUaDeviceStatusType			
PLC			
Resources			
SystemDefineDataType			
UserDefineDataType			



Execution Log Functions

This section describes how to use the Execution Logs for tracing the operations of the OPC UA Server.

7-1	Execution Logs	7-2
7-1-1	Overview	7-2
7-1-2	How to Use the Execution Log	7-3
7-1-3	Setting the Execution Log	7-4
7-1-4	Checking the Execution Log.....	7-4
7-1-5	Execution Log File Specifications.....	7-4
7-1-6	Format of Records.....	7-5
7-1-7	Examples of Records in Execution Log File.....	7-13
7-2	Checking the Execution Log.....	7-15
7-2-1	How to Check the Execution Log	7-15
7-2-2	Checking Logs in the Operation Log Window in the Sysmac Studio	7-15
7-2-3	Checking Logs with the SD Memory Card	7-18
7-2-4	Checking Logs by Using FTP Client Software	7-18
7-3	OPC UA Server Shutdown Function.....	7-20
7-3-1	Overview	7-20
7-3-2	Shutdown System	7-20
7-3-3	How to Execute the Shutdown Function	7-21
7-3-4	How to Check the Shutdown of the OPC UA Server.....	7-21
7-4	SD Memory Card Operations	7-22
7-4-1	Conditions for Saving Execution Log Files to the SD Memory Card	7-22
7-4-2	Directories Used for the OPC UA Server	7-22
7-4-3	Execution Log Operation When Replacing the SD Memory Card.....	7-22
7-4-4	Approximate Work Time for SD Memory Card Replacement.....	7-23
7-4-5	Replacement Timing of SD Memory Card.....	7-23

7-1 Execution Logs

This section provides an overview of the Operation Logs, operational procedures, settings and specifications for the Execution Logs.

7-1-1 Overview

The Execution Logs are used to trace operations on the CPU Unit of the OPC UA Server. They are saved to the SD Memory Card (sold separately) mounted in the CPU Unit.

The following can be checked with log codes and log names in the Execution Logs.

Refer to **Category Name, Log code, Log name, and Details** in the record formats of *7-1-5 Execution Log File Specifications* on page 7-4 for details.

Meaning of category name	Meaning of log name	Description
OPC UA server	OPC UA Server started	Registered when the power turns ON if the OPC UA Server Use Option is set to <i>Use</i> .
	Preparing of OPC UA Server started	Registered when the OPC UA server enters the <i>Preparing</i> state.
	OPC UA Server running	Registered when the OPC UA server enters the <i>Running</i> state.
	OPC UA Server shutdown completed	Registered when the OPC UA server enters the <i>Shutdown</i> state.
	OPC UA Server error	Registered when the OPC UA server enters the <i>Halt error</i> state.
	Maximum number of variables that can be published is exceeded	Registered when the maximum number of variables that can be published is exceeded.
	Variable including unsupported data type/invalid data	Registered for each variable or node when there are unsupported data types or nodes that cannot be published on the OPC UA server.
	Number of OPC UA public variables	Registered the total number of variables that the OPC UA Server publishes to clients, when the address space is re-prepared or changed.
	Details of OPC UA public variables	Registered details of the variables that the OPC UA Server publishes to clients, when the address space is re-prepared or changed.
Authentication	Application authentication	Registered when application authentication processing completes (successful or failure).
	User authentication	Registered when user authentication processing completes (successful or failure).
	Security settings updated	Registered when the security settings are updated.
Certificate	Server certificate updated	Registered when a server certificate is generated.
	Notice of expiration of server certificate	Registered only once when the expiration date of the server certificate is less than 31 days.
	Server certificate expired	Registered when the server certificate has expired.
	Server certificate mismatch	Registered when the IP address of the server and the IP address of the Controller are different.

Meaning of category name	Meaning of log name	Description
	Certificate added	Registered when the user adds a certificate in the CPU Unit by operating the Sysmac Studio.
	Certificate deleted	Registered when the user deletes a certificate in the CPU Unit by operating the Sysmac Studio.
	Certificate moved	Registered when the user moves a certificate in the CPU Unit by operating the Sysmac Studio.
	Certificate discarded	Registered when a certificate received from an OPC UA client is discarded without being saved because the number of certificates saved in the CPU Unit has reached the limit.
	Certificate Revocation List added	Registered when the user adds a Certificate Revocation List in the CPU Unit by operating the Sysmac Studio.
	Certificate Revocation List deleted	Registered when the user deleted a Certificate Revocation List in the CPU Unit by operating the Sysmac Studio.

The Execution Logs are recorded by setting **Execution Log** to **Record** from **Configurations and Setup - OPC UA Settings - OPC UA Server Settings** in Multiview Explorer of the Sysmac Studio.

When the Execution Logs are recorded, the Execution Log files are constantly saved to the SD Memory Card mounted in the CPU Unit while the OPC UA Server is running.

The Execution Logs are temporarily recorded in the internal buffer (volatile memory) of the CPU Unit and then saved to the SD Memory Card. While the SD Memory Card is being replaced, the execution logs are kept in the internal buffer (volatile memory) of the CPU Unit. When you insert an SD Memory Card, the Execution Logs temporarily stored in the internal buffer are then saved automatically to the SD Memory Card. Refer to *7-4-3 Execution Log Operation When Replacing the SD Memory Card* on page 7-22 for details.

You can check the contents of the Execution Logs in the **Execution Log** Tab Page of the Operation Log Window in the Sysmac Studio.



Precautions for Correct Use

When you use Execution Logs, be sure to insert an SD Memory Card into the CPU Unit. The Execution Logs are temporarily recorded in the internal buffer of the CPU Unit and then saved to the SD Memory Card. If no SD Memory Card is mounted at power-OFF or shutdown processing of the CPU Unit, the Execution Logs recorded in the internal buffer will be lost. In that case, an *Execution Log Save Failed* event (event code: 15000000 hex) will occur.

7-1-2 How to Use the Execution Log

Use the Execution Logs according to the following procedure.

Step

STEP1. Set Execution Log.



Reference

7-1-3 *Setting the Execution Log* on page 7-4

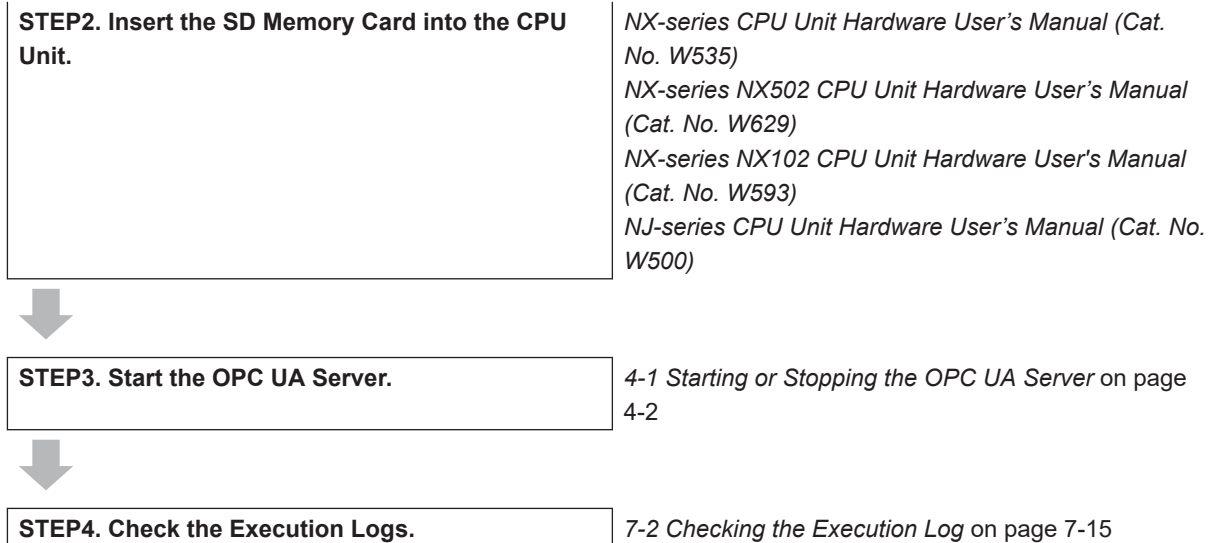

7-1-3 Setting the Execution Log

Set the following settings in **OPC UA Server Settings** from **Configurations and Setup - OPC UA Settings** in Multiview Explorer of the Sysmac Studio.

Setting	Description	Value
Execution Log	Set whether or not to record Execution Logs.	<ul style="list-style-type: none"> Do not record (Default) Record
Number of files	Set the maximum number of Execution Log files to be stored in the directory. When the maximum number of files is reached, the oldest file is deleted and a new file is created.	2 to 100 (Default: 24) Unit: files
Number of records	Set the number of records (logs) per Execution Log file. When the set number of records is reached, a file with the next serial number is created and then saved.	100 to 65,536 (Default: 12,000) Unit: records/file

7-1-4 Checking the Execution Log

Refer to *7-2 Checking the Execution Log* on page 7-15 to check Execution Logs.

7-1-5 Execution Log File Specifications

This section describes the specifications of Execution Log files.

- Each Execution Log file is composed of multiple records.
- Each record is expressed in one line.
- The maximum number of records to be contained in each Execution Log file is set in the Sysmac Studio.
- The size of each record is 256 bytes max.
- The following table shows file names and types.

File name	File type	Remarks
OPCUA_ExecutionLog.log	Latest log file in the log	---

File name	File type	Remarks
OPCUA_ExecutionLog_YYYYMMDDHHmmssSSS.log Note YYYY: Year, MM: Month, DD: Day HH; Hour, mm: minute, ss: Second, SSS: Milli-second If each digit is not used, the space is filled with a "0".	Log file in which maximum number of records reached	Example: OPCUA_Execution-Log_20170724220915040.log
OPCUA_ExecutionLog.fjc	System files	Log control file

Note The system time of the CPU Unit is used for the time information included in the file name.

- The files are stored in the following directories (in the SD Memory Card).
 - a) Log files:
/packages/OPCUA_Server/ExecutionLog/
 - b) Log control file:
/packages/OPCUA_Server/System/



Precautions for Correct Use

Do not delete the following files in the SD Memory Card.

- OPCUA_ExecutionLog.log (latest log file)
- OPCUA_ExecutionLog.fjc (log control file)

If they are deleted, the log files will not be saved correctly; for example, the Execution Log data will be lost.

7-1-6 Format of Records

The following is the format of records.

Each record is expressed in one line and composed of multiple parameters. The parameters are separated from each other by a tab.

Serial number<tab>**Date**<tab>**Time**<tab>**Millisecond**<tab>**Category name**<tab>**Log code**<tab>**Log name**<tab>**Details**CR+LF

Parameter	Size	Description
Serial number	1 to 5 bytes	0 to 65535 When 65,535 is exceeded, this value returns to 0. The serial number is given across multiple files. (Even if a new file is created, the serial number is not reset to 0.)
Date* ¹	10 bytes (Fixed)	Displays the year, month, and date when the log was recorded.* ¹ YYYY-MM-DD Example: 2017-06-23
Time* ¹	8 bytes (Fixed)	Displays hours, minutes, and seconds when the log was recorded.* ¹ hh:mm:ss Example: 15:33:45
Millisecond* ¹	3 bytes (Fixed)	Displays a 3-digit decimal integer (000 to 999) for the millisecond of the time when the log was recorded.* ¹ Example: 10 ms: 010 623 ms: 623
Category name* ²	16 bytes max. (Variable)	Displays the category.

Parameter	Size	Description
Log code	4 bytes (Fixed)	Displays a 4-digit decimal code that is a unique identification code in the category.
Log name	32 bytes max. (Variable)	Displays a name that indicates the contents of the log.
Details	168 bytes max. (Variable)	Displays the details of the Execution Log. In the Details parameter, information items are separated from each other by a tab. The number of information items in the Details parameter is variable. The contents differ according to the category. When it is output, CR + LF is removed.
CR+LF	2 bytes	Displays the end of the record.

*1. The system time of the CPU Unit is used for **Date**, **Time**, and **Millisecond**.

*2. **Category name:**

Category name	Meaning of category name	Description	Main usage
SERVER	OPC UA server	Records the state transition (operating state) of the OPC UA Server function.	Troubleshooting at device startup: When an OPC UA client cannot connect to the OPC UA Server function (to identify the primary cause), etc.
AUTH	Authentication	Records the execution results of application authentication and user authentication.	Troubleshooting at device startup: When an OPC UA client cannot connect to the OPC UA Server function, etc.
CERT	Certificate	Records changes to the server certificate, client certificate, CA certificate, and certificate revocation list maintained by the OPC UA Server function.	Troubleshooting while the device is in operation: When the OPC UA client that was able to connect in the past cannot connect to the OPC UA Server function, etc.

Category name, Log code, Log name, and Details are as follows:

Category name	Log code (Decimal)	Log name	Meaning of log name	Details
SERVER	0001	Start	OPC UA Server started	None
	0004	Prepare	Preparing of address space of OPC UA Server started	None
	0005	Run	OPC UA Server running	None
	0006	Shutdown	OPC UA Server shutdown completed	None
	0007	HaltError	OPC UA Server error	Error message 1. Refer to *1 below this table for a list of the error messages.

Category name	Log code (Decimal)	Log name	Meaning of log name	Details
	0100	MaxVariables	Maximum number of variables that can be published is exceeded	Format: Details 1 Details 1: <ul style="list-style-type: none"> • MaxVariables: The number of variables exceeded the upper limit. • MaxValues: The number of value attributes of a variable exceeded the upper limit. • MaxDataTypes: The number of structure definitions exceeded the upper limit.

Category name	Log code (Decimal)	Log name	Meaning of log name	Details
	0101	InvalidDataType/ InvalidData	Variable including unsupported data type/invalid data	<p>Format: Details 1 <tab> Details 2 <tab> Details 3</p> <p>Details 1:</p> <ul style="list-style-type: none"> Variable name or node name: Up to 60 bytes is displayed for the name of each variable or node that cannot be published. Note In the case of multibyte characters, the last character may not be displayed correctly. <p>Details 2:</p> <ul style="list-style-type: none"> MultiDimensionalArray: Structure containing a two-dimensional or higher multidimensional array specified structure^{*2} as a member Union: Union is included SubscriptOfArray: <ul style="list-style-type: none"> a) Array not beginning with the starting number of "0" b) Member of structure containing array not beginning with the starting number of "0" c) Subscript containing "" (variable-length array) NestedStructure: Number of nesting levels of structure exceeds upper limit MaxMembers: Number of members of structure exceeds upper limit MaxSize: Variable size exceeds upper limit MaxArrayElements: Number of elements of array variable exceeds upper limit NoMapping: The variable that can be mapped is not found RegisteredNodeId: The name is same as NodeId Namespace: The node for namespace cannot be created ReservedWord: Node names that cannot be published in the OPC UA address space are used for nodes corresponding to global variables, program names, and user-defined data type names <p>Details 3:</p> <ul style="list-style-type: none"> Variable size: When Details 2 is <i>MaxSize</i>, the variable size is recorded (decimal number, unit is bytes). When Details 2 is <i>Namespace</i>, if there is information of the namespace, it is recorded. Otherwise, there is no Details 3. <p>Note If one variable or node includes more than one of the above factors, only the first detected factor is recorded.</p>

Category name	Log code (Decimal)	Log name	Meaning of log name	Details
	0110	NumOfVariables	Number of OPC UA public variables	Format: Variables=xxxx, Values=xxxx, Data-Types=xxxx Variables: Total number of OPC UA public variables Values: Total number of value attributes of OPC UA public variables DataTypes: Total number of structure definitions of OPC UA public variables
	0111	PublishedVariable	Details of OPC UA public variables	Format: VarName<tab>VarSize<tab>NumOfValues<tab>NumOfMembers <ul style="list-style-type: none"> VarName: Variable name published to OPC UA clients (Up to 60 bytes to be displayed) Note In the case of multibyte characters, the last character may not be displayed correctly. VarSize: Variable size (decimal number, unit is byte) NumOfValues: Number of value attributes of variable (decimal, unit is attribute but is not recorded) NumOfMembers: When the data type of the variable is structure, number of members of the structure (decimal, unit is member but is not recorded) Note 0 (zero) when the data type of the variable is not structure.
AUTH	0001	Application	Application authentication	- When connected <ul style="list-style-type: none"> In normal status Format: OPEN<tab>SessionID<tab>IP address of connecting client<tab>Host information of client certificate In error status Format: ERROR<tab>Error message Note Refer to ^{*3} below this table for a list of error messages. - When disconnected Format: CLOSE<tab> SessionID
	0002	User	User authentication	<ul style="list-style-type: none"> In normal status Format: Success<tab>SessionID<tab>User name In error status Format: ERROR<tab>User name<tab>Error message Note Refer to ^{*4} below this table for a list of error messages.
	0100	Update	Security settings updated	None

Category name	Log code (Decimal)	Log name	Meaning of log name	Details	
CERT	0001	Update_Server	Server certificate updated	Format: Distinguished name (common name) of certificate<tab>Expiration date of certificate	
	0002	Notify_Server	Notice of expiration of server certificate	<ul style="list-style-type: none"> Distinguished name (common name) of certificate: Up to 60 bytes maximum from the beginning is output. Expiration date of certificate: YYYY-MM-DDThh:mm:ssZ (The expiration date of the certificate is expressed in UTC. When it is recorded in the Details, it is recorded in UTC as well.) 	
	0003	Expired_Server	Server certificate expired		
	0004	Mismatch_Host	Server certificate mismatch		
	0100	Add	Certificate added	Format: Distinguished name (common name) of certificate<tab>Expiration date of certificate<tab>Details 1	Details 1: Type of certificate<tab>Store location
	0101	Delete	Certificate deleted	<ul style="list-style-type: none"> Distinguished name (common name) of certificate: Up to 60 bytes maximum from the beginning is output. Expiration date of certificate: YYYY-MM-DDThh:mm:ssZ (The expiration date of the certificate is expressed in UTC. When it is recorded in the details, it is recorded in UTC.) Details 1 Refer to the right. 	Details 1: Type of certificate<tab>Store location
	0102	Move	Certificate moved		Details 1: Type of certificate<tab>Store location->Store location
					<ul style="list-style-type: none"> Type of certificate: CLIENT: Client certificate Store location: TRUSTED: Trusted certificate list ISSUER: CA certificate list REJECTED: Rejected certificate list
					<ul style="list-style-type: none"> Type of certificate: CLIENT: Client certificate Store location->Store location: REJECTED->TRUSTED (Fixed)

Category name	Log code (Decimal)	Log name	Meaning of log name	Details
	0103	Discard	Certificate discarded	<p>Details 1:</p> <p>Type of certificate<tab>Store location</p> <ul style="list-style-type: none"> Type of certificate: CLIENT: Client certificate Store location: REJECTED: Rejected certificate list (Fixed) <p>Note In the following cases, the <i>Certificate discarded</i> Execution Log is not recorded (it is recorded in the event log).</p> <ul style="list-style-type: none"> Memory all cleared Unsupported OPC UA project downloaded Unsupported OPC UA project restored
	0200	Add_Crl	Certificate Revocation List added	<p>Format:</p> <p>File name<tab>Distinguished name (common name) of CA<tab>Expiration date of revocation list<tab>Type of revocation list<tab>Store location</p>
	0201	Delete_Crl	Certificate Revocation List deleted	<ul style="list-style-type: none"> File name: Up to 60 bytes from the beginning is output. Distinguished name (common name) of CA: Up to 60 bytes from the beginning is output. Expiration date of revocation list: YYYY-MM-DDThh:mm:ssZ Type of revocation list: CLIENT: Client certificate revocation list Store location: TRUSTED: Certificate Trust List ISSUER: Root certificate / intermediate certificate list <p>Note Revocation list deleted only: In the following cases, the <i>Revocation list deleted</i> Execution Log is not recorded (it is recorded in the event log)</p> <ul style="list-style-type: none"> Memory all cleared Unsupported OPC UA project downloaded Unsupported OPC UA project restored

Category name	Log code (Decimal)	Log name	Meaning of log name	Details
	0300	Invalid	Invalid certificate	Format: Certificate distinguished name (common name) <ul style="list-style-type: none"> This log is recorded when the application instance certificate check as an OPC UA specification detects a violation. This log is recorded when a client certificate constraint is violated. Refer to <i>Client Certificate Constraints</i> on page 3-19 for client certificate constraints. Distinguished name (common name) of certificate: Up to 60 bytes from the beginning is output.
Method*5	1	Start	Method started	Format: Method name The details of the start of the Method are recorded.
	2	Completed	Normal end of Method	Format: Method name The details of the normal end of the Method are recorded.
	3	Error	Error end of Method	Format: Method name<tab>Error message *6 The details of the error end of the Method are recorded.

*1. HaltError (OPC UA Server Error) Error Message List

Error message	Meaning
Configuration Error	Reading of the OPC UA Settings file failed. [Cause] There is no OPC UA Settings file. Or the file is damaged. [Measure] Download the OPC UA Settings file.
Server Start Error	Preparing of address space failed. [Cause] The TCP port number is duplicated. [Measure] Change the TCP port number and download the settings.
OPC UA System Error	A fatal error was detected. [Cause] An error occurred in the software. [Measure] Turn the power OFF and then back ON.
Out of Memory	The heap size of the memory used after address space configuration exceeded the upper limit. [Cause] The heap size of the memory used after address space configuration exceeded the upper limit. [Measure] Reduce the number of public variables.

*2. The *multidimensional array specified structure* indicates two-dimensional or higher array specifications in which the elements are structures.

*3. Application (Application Authentication) Error Message List

Error message	Meaning
BadCertificateInvalid	The certificate signature is incorrect. The certificate may have been tampered with.
BadCertificateIssuerRevocationUnknown	It is unclear whether the CA certificate of the client certificate etc. can be trusted because the revocation list is inaccessible.

Error message	Meaning
BadCertificateIssuerRevoked	The CA certificate has been expired, etc.
BadCertificateIssuerTimeInvalid	The CA certificate validity period is out of range.
BadCertificateRevocationUnknown	It is unclear whether the certificate of the client certificate etc. can be trusted because the revocation list is inaccessible.
BadCertificateRevoked	The CA certificate has been expired.
BadCertificateTimeInvalid	The certificate validity period is out of range.
BadCertificateUntrusted	The certificate is issued by an untrusted CA.
BadTooManySessions	The number of sessions has exceeded.

*4. User (User Authentication) Error Message List

Error message	Meaning
BadUserAccessDenied	The user name or password is incorrect.
BadIdentityTokenRejected	An anonymous login was requested when anonymous logins are prohibited.

*5. For the unit versions of the following CPU Units

NJ501-1□□00: Version 1.62 or later

NX102-□□□□: Version 1.64 or later

NX502-1□□00: Version 1.64 or later

NX701-1□□□: Version 1.34 or later

*6. Error end of Method Error Message List

Error message	Meaning
BadRequestTimeout	When a timeout occurs.
BadInternalError	When not in RUN mode (in the following cases). <ul style="list-style-type: none"> • During PROGRAM mode • While downloading • During major fault
BadNotExecutable	When the Executable attribute is False.
BadArgumentsMissing	When input arguments are missing.
BadTooManyArguments	When there are too many input arguments.
BadInvalidArgument	When the number of array elements or array dimensions in the input argument is incorrect. When the data type of the input argument is incorrect. If the input argument value is outside of the range
BadInvalidState	When there is an error in the execution processing for Method.
BadMethodInvalid	When there is no execution processing for Method.

7-1-7 Examples of Records in Execution Log File

The following shows examples of records in an Execution Log file.

- Example of when the power is turned ON and the OPC UA Server is started.

0 2017-10-17 14:52:50 747 SERVER 0001 Start

1 2017-10-17 14:52:50 749 SERVER 0004 Prepare

2 2017-10-17 14:52:50 877 SERVER 0111 PublishedVariable Var1 2Byte 1 0

3 2017-10-17 14:52:50 878 SERVER 0111 PublishedVariable Var2 6Byte 3 3

4 2017-10-17 14:52:50 878 SERVER 0111 PublishedVariable Var3 2Byte 1 0

5 2017-10-17 14:52:50 878 SERVER 0111 PublishedVariable Var4 10Byte 5 0

6 2017-10-17 14:52:50 878 SERVER 0110 NumOfVariables Variables=4, Values=10, DataTypes=1

7 2017-10-17 14:52:50 889 SERVER 0005 Run

- Example of when an error occurs after a connection request from a client

8 2017-10-17 14:54:11 822 AUTH 0001 Application ERROR BadCertificateUntrusted

9 2017-10-17 14:54:11 844 CERT 0103 Discard UaClient_1@SamplePC

2022-10-03T08:19:54.000ZCLIENTREJECTED

- Example of when the user moved a client certificate from the Rejected Certificate List to the Trusted Certificate List:

10 2017-10-17 14:54:28 929 CERT 0102 Move UaClient_1@SamplePC

2022-10-03T08:19:54.000ZCLIENTREJECTED->TRUSTED

- Example of when user authentication and application authentication end successfully, following a re-connection request from a client.

11 2017-10-17 14:54:39 250 AUTH 0002 User SUCCESS 0x2ADA356B Anonymous

12 2017-10-17 14:54:39 251 AUTH 0001 Application OPEN 0x2ADA356B 192.168.255.2 Ua-Client_1@SamplePC

- Example of when the user shut down the OPC UA Server:

60 2017-10-17 16:05:45 323 SERVER 0006 Shutdown

7-2 Checking the Execution Log

This section describes how to check Operation Logs stored in the SD Memory Card mounted in the CPU Unit.

7-2-1 How to Check the Execution Log

You can use any of the following methods to check the Execution Log.

- Checking logs in the Operation Log Window in the Sysmac Studio
- Checking logs with the SD Memory Card
- Checking logs by transferring data using FTP client software



Precautions for Correct Use

Execution Log file is encoded in UTF-8.

7-2-2 Checking Logs in the Operation Log Window in the Sysmac Studio

You can use the following method to check the Execution Logs stored in the SD Memory Card from the Operation Log Window of the Sysmac Studio.

The Operation Log Window is available for operation only when the CPU Unit has an SD Memory Card mounted and is connected online.

- 1 Go online with the CPU Unit from the Sysmac Studio, right-click **OPC UA Settings** under **Configurations and Setup** in the Multiview Explorer, and select **Show Operation Logs**.

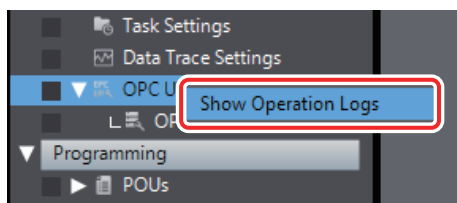

The following Operation Log Window is displayed.

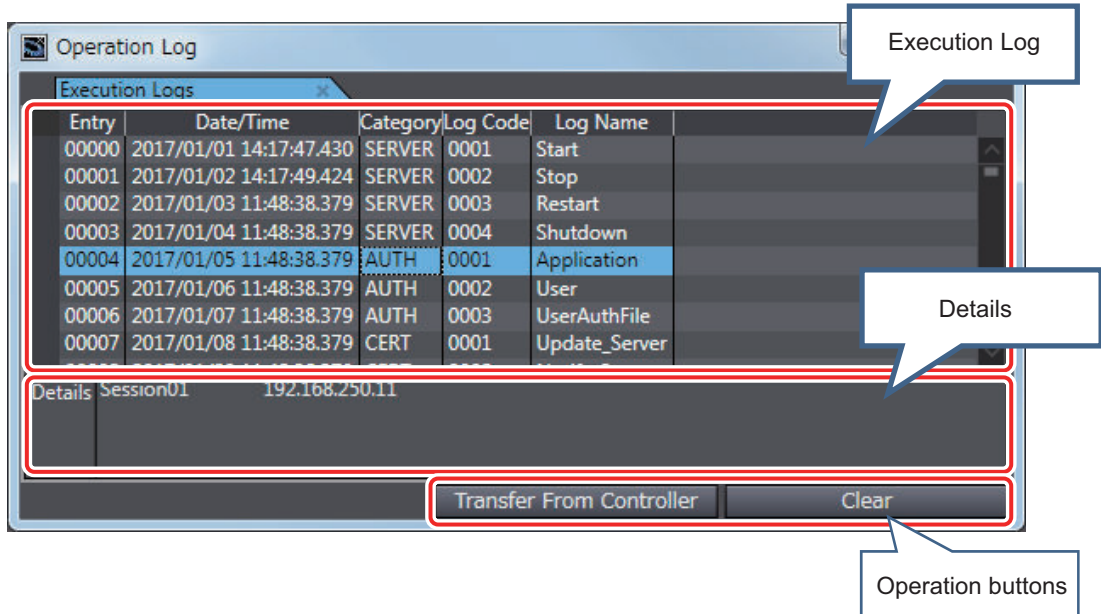

The following information is displayed.

Category	Item	Description
Execution Logs		Displays a list of log records. Displays the Entry, Date/Time, Category, Log Code, Operation and Log Name columns. The default data is displayed in the ascending order of entries. Clicking each column header sorts the list according to the name of the corresponding item. Each click switches between ascending and descending order.
	Entry	Displays a serial number.
	Date/Time	Displays a date and time in the <i>Year/Month/Day/ Hour:Minute:Second.ms</i> format.
	Category	Displays a category.
	Log Code	Displays a log code.
	Log Name	Displays a log name.
Details		Displays the details of the log.
Operation buttons	Transfer From Controller Button	Acquires the log files. Refer to <i>Acquiring Log Files</i> on page 7-16 below for details.
	Clear Button	Clears the log files. Refer to <i>Clearing the Execution Logs</i> on page 7-17 below for details.

● Acquiring Log Files

Acquire the log files in the SD Memory Card inserted in the CPU Unit

- 1 Click the **Transfer From Controller** Button to acquire the log files from the Controller and display a list of the log files in the following **Operation Log** Dialog Box.

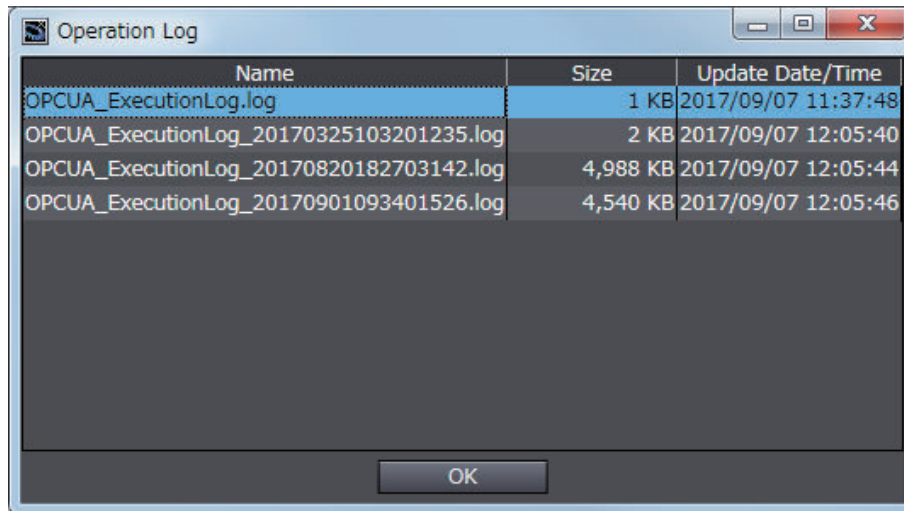

- 2** Select a log file to display and click the **OK** Button. The log file is uploaded.

Note If a log file of the same name exists on the computer, the following message is displayed.

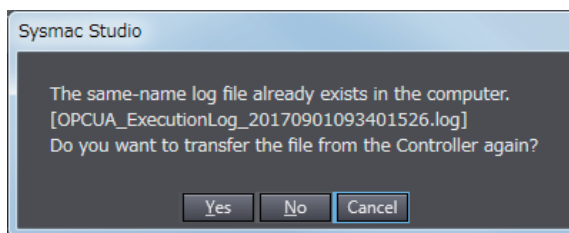

Select from the following options.

Yes: Acquires the specified file from the Controller and then displays it.

No: Displays the contents of the file that already exists on the computer without acquiring the selected file from the Controller.

Cancel: The file list is displayed again.

Note If the selected log file is bigger than 10 MB, the following message is displayed.

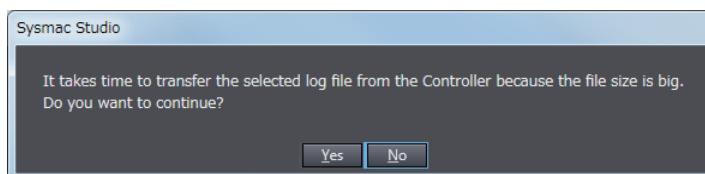

Select from the following options.

Yes: Acquires the specified file from the Controller and displays it.

No: Goes back to the list again.

● Clearing the Execution Logs

Clear the log files in the SD Memory Card inserted in the CPU Unit.

- 1** Click the **Clear** Button. The following confirmation message is displayed.

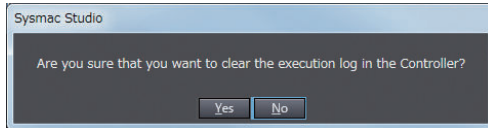

- 2 Click the **Yes** Button to clear the log files in the SD Memory Card inserted in the CPU Unit.

● Failure of Execution Log Saving

Saving of the Execution Logs will fail in the following cases.

- The OPC UA Server is started while an SD Memory Card is not mounted.
- The OPC UA Server is started while an SD Memory Card is mounted but the type or format is invalid, write protection is set, there is insufficient space, or a failure has occurred.

In that case, an *Execution Log Save Failed* event (event code: 15000000 hex) will occur.

7-2-3 Checking Logs with the SD Memory Card

Remove the SD Memory Card from the CPU Unit and insert it into a computer. Then, check the contents of the logs in Microsoft Excel or a text editor or any other application.

For the conditions for saving execution log files to the SD Memory Card and the method of replacing the SD Memory Card, refer to *7-4 SD Memory Card Operations* on page 7-22.

7-2-4 Checking Logs by Using FTP Client Software

You can transfer the log files using the FTP Server function via the Ethernet network and check the contents in Microsoft Excel or a text editor or any other application.

Use the following procedure.

Use the FTP server function of the built-in EtherNet/IP port.

- 1 Select the **Use** Option for the **FTP server** in the **FTP Settings**, which is displayed following **Configurations and Setup - Built-in EtherNet/IP Port Settings** in the Multiview Explorer of the Sysmac Studio.
For details on how to make the settings, refer to the *NJ/NX-series CPU Unit Built-in EtherNet/IP Port User's Manual (Cat. No. W506)*.
- 2 Using the FTP client software, input the FTP login name and password that you set in the Built-in EtherNet/IP Port Settings to log into the CPU Unit.
- 3 Move to the folder where the execution log files are stored.
`cd \MEMCARD1\packages\OPCUA_Server\ExecutionLog\`
- 4 Acquire the Execution Log files.
For example, to acquire multiple log files to which writing has been completed, specify a wild card with the `mget` command as shown below.
`mget OPCUA_ExecutionLog*.log`
- 5 Disconnect the FTP client software from the CPU Unit.

- 6 Open the acquired Execution Log files in Microsoft Excel or a text editor or any other application to check the contents.

7-3 OPC UA Server Shutdown Function

This section describes the shutdown function of the OPC UA Server for preventing Execution Log data loss.

Refer to 4-2 *Checking the Status of the OPC UA Server* on page 4-5 for details on the operating statuses of the OPC UA Server.

7-3-1 Overview

The OPC UA server shutdown function (hereinafter called *shutdown function*) is used to shut down the OPC UA Server after saving the execution files to the SD Memory Card.

Execute the shutdown function before turning OFF the power supply to the CPU Unit. You can prevent Execution Log data loss by executing the shutdown function.



Precautions for Correct Use

If the power supply to the CPU Unit is turned OFF without executing the shutdown function while the OPC UA Server is running, the contents of the Execution Logs cannot be guaranteed. The Execution Log files may be corrupted or the data may be lost.



Additional Information

To prevent data loss due to an unexpected power interruption, we recommend that you take measures against power interruptions such as the installation of an uninterruptible power supply system.

7-3-2 Shutdown System

The following figure shows the shutdown system.

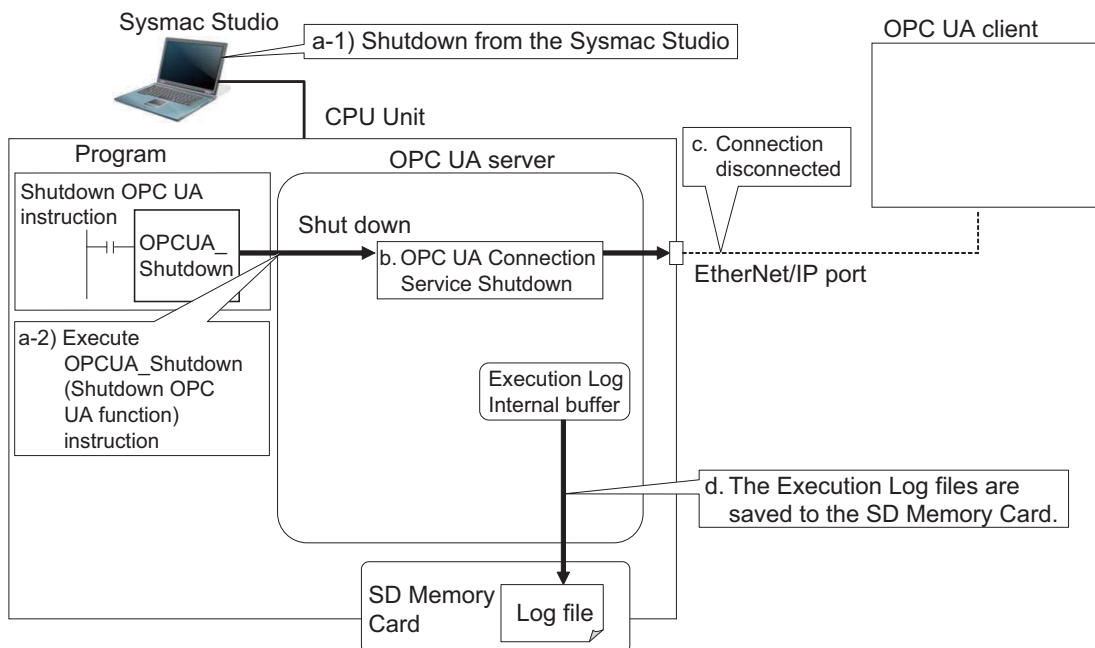

- The OPC UA Server is shut down by one of the followings: (1) Using the Sysmac Studio Or (2) Executing the OPCUA_Shutdown (Shutdown OPC UA Function) instruction

- b. The OPC UA Server shuts down.
- c. The connection is closed.
- d. The Execution Log files are saved to the SD Memory Card.

7-3-3 How to Execute the Shutdown Function

You can execute the shutdown function by performing either of the following operations.

- Sysmac Studio operation
- Instruction execution

Sysmac Studio Operation

- 1** Right-click **OPC UA Server Settings** from **OPC UA Settings** under **Configurations and Setup** in the Multiview Explorer of the Sysmac Studio and select **Server Status** while connecting online with an NJ/NX-series CPU Unit. The **Service Status** Tab Page is displayed.
- 2** Click the **Server shutdown** Button.
For details on the procedure, refer to *Shutting Down the Server Function* on page 4-6 on *4-2-1 Checking Based on OPC UA Server Status of the Sysmac Studio* on page 4-5.



Additional Information

When you execute the Reset Controller operation on the Sysmac Studio, the OPC UA server shutdown function is automatically executed before resetting the Controller.

Instruction Execution

Execute the OPCUA_Shutdown (Shutdown OPC UA Function) instruction.

Refer to *A-2 OPC UA Instructions* on page A-9 for details on the OPC UA instruction.

7-3-4 How to Check the Shutdown of the OPC UA Server

Confirm that the OPC UA Server has been shut down by the following method before turning OFF the power supply to the CPU Unit.

- Checking with OPC UA Server Status of the Sysmac Studio
Confirm that the **Server operating status** in **Operation Information** is *Shutdown* in the **Server Status** Tab Page.
- Checking by executing an instruction
For details of the procedure, refer to *4-2-1 Checking Based on OPC UA Server Status of the Sysmac Studio* on page 4-5.

Confirm that the *Done* output variable of the OPCUA_Shutdown (Shutdown OPC UA Function) instruction is TRUE.

Refer to *A-2 OPC UA Instructions* on page A-9 for details on the OPC UA instruction.

7-4 SD Memory Card Operations

In the OPC UA Server, the SD Memory Card mounted in the CPU Unit is used for the Execution Log function.

The Execution Log files are stored in the SD Memory Card.

This section describes how to save the Execution Log files in the SD Memory Card and precautions for replacing the SD Memory Card.

Refer to the *NJ/NX-series CPU Unit Software User's Manual (Cat. No. W501)* for details on the SD Memory Card functions.

7-4-1 Conditions for Saving Execution Log Files to the SD Memory Card

Execution Log files are saved to the SD Memory Card under the following condition.

Operation to use the function	Conditions for saving log files on SD Memory Card
Set Execution Log to Record in OPC UA Server Settings of the Sysmac Studio.	Constantly saved while the OPC UA Server is running* ¹ .

*1. If the power supply to the CPU Unit is turned ON while no SD Memory Card is mounted in the CPU Unit, an *Execution Log Save Failed* event (event code: 15000000 hex) is registered in the event log when an Execution Log is saved. Recording of the Execution Logs starts when an SD Memory Card is inserted into the CPU Unit.

Even while the Server operating status of the OPC UA Server is *preparing* or *running*, recording of the Execution Log files will just start at the point of time when an SD Memory Card is inserted.

7-4-2 Directories Used for the OPC UA Server

The OPC UA Server uses the directories under "packages/OPCUA_Server" in the SD Memory Card as shown in the following table. The details are as follows.

Directory	Description
/packages/OPCUA_Server/ExecutionLog	Contains the Execution Log files.
/packages/OPCUA_Server/System	Contains the system files (log control file).



Precautions for Correct Use

Do not delete the following files in the SD Memory Card.

- OPCUA_ExecutionLog.log (latest log file)
- OPCUA_ExecutionLog.fjc (log control file)

If they are deleted, the log files will not be saved correctly; for example, the Execution Log data will be lost.

7-4-3 Execution Log Operation When Replacing the SD Memory Card

This section describes the Execution Log operation when the SD Memory Card is replaced while the OPC UA Server is running.

Status during SD Memory Card Replacement		
When the SD Memory Card power switch is pressed	When no SD Memory Card is mounted	When an SD Memory Card is inserted
Stopped. If Execution Logs are contained in the internal buffer of the CPU Unit, they are recorded in the SD Memory Card.	Execution logs are not recorded.	The Execution Logs that were temporarily saved in the internal buffer are automatically recorded in the SD Memory Card.

7-4-4 Approximate Work Time for SD Memory Card Replacement

If you replace the SD Memory Card while the OPC UA Service is running, replace the SD Memory Card within the following time frames, depending on the interval at which the Execution Log is recorded.

● Approximate Time for Replacement Work

Examples of Execution Log recording intervals		
50-ms interval	100-ms interval	500-ms interval
30 seconds	60 seconds	300 seconds (5 minutes)



Precautions for Correct Use

Please note the following for replacing the SD Memory Card.

- When a project is downloaded from the Sysmac Studio and when the OPC UA Server is being prepared again, a large number of Execution Logs are written to the internal buffer. Therefore, do not replace the SD Memory Card for approximately five minutes after the download or the OPC UA Server preparation. If it is replaced before five minutes pass, the Execution Logs recorded in the internal buffer may be lost.
- Use a formatted SD Memory Card when replacing the SD Memory Card.
- When you replace the SD Memory Card while Execution Logs are being recorded, press the SD Memory Card power switch and insert a new SD Memory Card within the corresponding approximate time for replacement work after the SD PWR indicator turns OFF.
- If it takes longer than the corresponding approximate time for replacement work, the Execution Logs recorded in the internal buffer may be lost.

If the internal buffer space becomes full before inserting the SD Memory Card, an *Execution Log Save Failed* event (event code: 15000000 hex) is registered in the event log.

7-4-5 Replacement Timing of SD Memory Card

● How to Know the Replacement Timing of the SD Memory Card

You can know the replacement timing of the SD Memory Card by checking the *SD Memory Card Life Exceeded* event or the *_Card1Deteriorated* (SD Memory Card Life Warning Flag) system-defined variable.



Version Information

Combination of the CPU Unit version and SD Memory Card determines whether the SD Memory Card life expiration detection function can be used or not. Refer to *Specifications of Supported SD Memory Cards, Folders, and Files* in the *NJ/NX-series CPU Unit Software User's Manual (Cat. No. W501)* for details.



Other Functions

This section describes other functions of the OPC UA Server.

8-1	The Sysmac Studio Operation Authority Verification Related to the OPC UA Server.....	8-2
8-2	Backup and Restore Functions Related to the OPC UA Server	8-4
8-2-1	Backup Function.....	8-4
8-2-2	Restoration and Verification	8-5
8-2-3	Compatibility between Backup-related Files	8-7
8-2-4	How to Replace the CPU Unit in Relation to the OPC UA Server.....	8-7
8-3	Clear All Memory Function Related to the OPC UA Server.....	8-9

8-1 The Sysmac Studio Operation Authority Verification Related to the OPC UA Server

This section describes the Sysmac Studio operation authority verification related to the OPC UA Server.

This function is used to restrict online operations on the CPU Unit via the Sysmac Studio based on the granted authority.

Refer to the *NJ/NX-series CPU Unit Software User's Manual (Cat. No. W501)* and the *Sysmac Studio Version 1 Operation Manual (Cat. No. W504)* for the details and operating procedure of the operation authority verification function.

The following table indicates online operations related to the OPC UA Server based on the authority level.

OP: Operation possible, NP: Operation not possible

Function		Admin-istrator	De-signer	Main-tainer	Opera-tor	Ob-server	Reference
Server certificate	Display and update	OP	OP	OP	OP	NP	<i>3-2-5 Setting and Displaying the Certificate</i> on page 3-12
	Export	OP	NP	NP	NP	NP	
	Regenerate	OP	NP	NP	NP	NP	
Client authentication	Display and update	OP	OP	OP	OP	NP	
	Add certificate	OP	NP	NP	NP	NP	
	Delete certificate	OP	NP	NP	NP	NP	
	Move certificate	OP	NP	NP	NP	NP	
	View certificate details	OP	OP	OP	OP	NP	<i>A-3 When CA-Signed Client Certificates Supported</i> on page A-14
	Add Certificate Revocation List	OP	NP	NP	NP	NP	
	Delete Certificate Revocation List	OP	NP	NP	NP	NP	
	View Certificate Revocation List details	OP	OP	OP	OP	NP	

Function		Admin- istrator	De- signer	Main- tainer	Opera- tor	Ob- server	Reference
Issuer authentication	Display and update	OP	OP	OP	OP	NP	<i>A-3 When CA-Signed Client Certificates Supported on page A-14</i>
	Add certificate	OP	NP	NP	NP	NP	
	Delete certificate	OP	NP	NP	NP	NP	
	Move certificate	OP	NP	NP	NP	NP	
	View certificate details	OP	OP	OP	OP	NP	
	Add Certificate Revocation List	OP	NP	NP	NP	NP	
	Delete Certificate Revocation List	OP	NP	NP	NP	NP	
Security settings (user authentication settings, anonymous login, and security policy)	Display and edit	OP	OP	OP	OP	NP	<i>3-2-6 Security Settings on page 3-24</i>
	Transfer security settings	OP	NP	NP	NP	NP	
Service status	Display and update	OP	OP	OP	OP	NP	<i>4-2-1 Checking Based on OPC UA Server Status of the Sysmac Studio on page 4-5</i>
	Shut down server	OP	OP	NP	NP	NP	
Execution Logs	Display	OP	OP	OP	OP	NP	<i>Section 7 Execution Log Functions on page 7-1</i>
	Clear	OP	OP	OP	NP	NP	

8-2 Backup and Restore Functions Related to the OPC UA Server

This section describes the functions for backing up and restoring data in the NJ/NX-series CPU Unit that are related to the OPC UA Server.

There are four types of features for backup and restoration. Refer to the *NJ/NX-series CPU Unit Software User's Manual (Cat. No. W501)* for details on each function.

Function	Description	Backup function	Restore function
SD Memory Card backups	This function allows you to save various settings data in the NJ/NX-series CPU Unit to the SD Memory Card and restore the settings data in the CPU Unit by performing an operation on the CPU Unit.	Available	Available
Sysmac Studio Controller backups	This function allows you to save various settings data in the NJ/NX-series CPU Unit to a PC and restore the settings data in the CPU Unit by using the Sysmac Studio.	Available	Available
Program transfer from SD Memory Card	With the <code>_Card1PrgTransferCmd</code> (SD Memory Card Program Transfer Command) system-defined variable, you can transfer a program stored in the SD Memory Card mounted in the CPU Unit to the Controller.	Unavailable	Available
Automatic transfer from SD Memory Card	This function automatically transfers the data of the backup file in the <code>/autoload</code> directory of the SD Memory Card in the CPU Unit to the Controller when the power is turned ON.	Unavailable	Available



Precautions for Correct Use

The server certificate is not target for backup and restore because it is information belonging to individual CPU Units. If you replace the CPU Unit hardware, you cannot use the same server certificate for the new CPU Unit after the replacement.

Even if you set the IP address of the built-in EtherNet IP port to the same value as the one for the previous CPU Unit, be sure to export the server certificate of the new CPU Unit and then perform installation again on the OPC UA clients.

Refer to *3-2-5 Setting and Displaying the Certificate* on page 3-12 for how to export the server certificate.

8-2-1 Backup Function

The following table indicates OPC UA Server-related data to be backed up by the CPU Unit backup function.

Data	Data group for back up	Save location	Backed up by one of the following <ul style="list-style-type: none"> SD Memory Card backups Sysmac Studio Controller backups
OPC UA Server Settings	<i>User program and settings</i>	Non-volatile memory	Applicable
Server certificate	<i>OPC UA server certificate</i>	Non-volatile memory	Not applicable

Data	Data group for back up	Save location	Backed up by one of the following <ul style="list-style-type: none"> SD Memory Card backups Sysmac Studio Controller backups
Client certificate	<i>OPC UA security profile</i>	Non-volatile memory	Applicable* ¹
CA certificate		Non-volatile memory	Applicable* ¹
Certificate Revocation List		Non-volatile memory	Applicable* ¹
Security settings (user authentication settings, anonymous login, and security policy)		Non-volatile memory	Applicable* ¹
Execution logs	---	SD Memory Card	Not applicable
Event logs	<i>Event logs</i>	Backup memory	Applicable

*1. Not to be backed up by the backup function when the file is being exported or imported via the Sysmac Studio.



Precautions for Correct Use

- When you import the data of a backup file created with the SD Memory Card backup function to a Sysmac Studio project and when you export the data of a Sysmac Studio project to a backup file, *client certificates*, *security settings*, and *Execution Logs* cannot be imported/exported. Please note that only *OPC UA Server Settings* can be imported/exported.



Additional Information

The Execution Log is not covered by the backup/restore function. If you want to keep the Execution Log data after replacement of the CPU Unit, insert the SD Memory Card used for the previous CPU Unit into the new CPU Unit for restoration, after the restore completes.

8-2-2 Restoration and Verification

The following table shows OPC UA Server data items to be restored and verified by the CPU function.

Data	Data group of the backup function for each data	Save location	Restoration		Verification
			Restored by one of the following <ul style="list-style-type: none"> SD Memory Card restore function Sysmac Studio Controller backups 	Restored by one of the following <ul style="list-style-type: none"> Automatic transfer from SD Memory Card Program transfer from SD Memory Card 	Verified by one of the following <ul style="list-style-type: none"> SD Memory Card backups Sysmac Studio Controller backups
OPC UA Server Settings	<i>User program and settings</i>	Non-volatile memory	Applicable	Applicable	Applicable

Data	Data group of the backup function for each data	Save location	Restoration		Verification
			Restored by one of the following <ul style="list-style-type: none"> SD Memory Card restore function Sysmac Studio Controller backups 	Restored by one of the following <ul style="list-style-type: none"> Automatic transfer from SD Memory Card Program transfer from SD Memory Card 	Verified by one of the following <ul style="list-style-type: none"> SD Memory Card backups Sysmac Studio Controller backups
Server certificate	<i>OPC UA server certificate</i>	Non-volatile memory	Not applicable	Not applicable	Not applicable
Client certificate	<i>OPC UA security profile</i>	Non-volatile memory	Depends on the selection*1		
CA certificate					
Certificate Revocation List					
Security settings (user authentication settings, anonymous login, and security policy)					
Execution logs	---	SD Memory Card	Not applicable		
Event logs	<i>Event logs</i>	Backup memory	Not applicable		

*1. You can select whether or not to allow these types of data to be restored by the function. Refer to the next section *How to Select Whether or Not to Set OPC UA Security Profile as a Restore Target* on page 8-6 for the selection procedure.

How to Select Whether or Not to Set OPC UA Security Profile as a Restore Target

For restoring using the SD Memory Card restore function or the Sysmac Studio Controller backups, you can select whether or not to restore the client certificates, CA certificates, Certificate Revocation List, and security settings together as the *OPC UA Security Profile*.

The selection procedures are as follows.

● When Using the SD Memory Card Restore Function

There are two ways as below:

- When using the CPU Unit front panel switches and turning the power ON
You can select whether or not to restore the *OPC UA Security Profile* by setting the restore command file (RestoreCommand.ini) as shown below.

Contents (defaults when the file is created)	Description
<pre>[Restore] ; --- User Program and Configuration. --- ; Always select "yes". UserProgram=yes : : ; --- OPC UA Security Profile. --- ; "yes":will be restored, "no":will not be re- stored OpcuaSPF=yes</pre>	<p>Refer to the <i>NJ/NX-series CPU Unit Software User's Manual (Cat. No. W501)</i> for an explanation.</p> <hr/> <p>OPC UA security profile yes/no: Restore/Do not restore.</p>

- When using system-defined variables
You can use the `_Card1RestoreCmdTargetOpcuaSPF` (OPC UA Security Profile Transfer Flag) system-defined variable, as shown in detail below.

Variable name	Name	Function	Data type	Range of values
<code>_Card1RestoreCmdTargetOpcuaSPF</code>	OPC UA Security Profile Transfer Flag	When restoring <i>OPC UA security profile</i> in the SD Memory Card to the Controller, set this to TRUE.	BOOL	TRUE, FALSE

● When Using the Sysmac Studio Controller Backups

You can select whether or not to restore the *OPC UA Security Profile* by setting the *Restore Target File* in the **Restore** Dialog Box on the Sysmac Studio.

8-2-3 Compatibility between Backup-related Files

Refer to *Compatibility between Backup-related Files* in the *NJ/NX-series CPU Unit Software User's Manual (Cat. No. W501)* for details on compatibility between backup files.

8-2-4 How to Replace the CPU Unit in Relation to the OPC UA Server

The following shows how to replace the CPU Unit in relation to the OPC UA Server.

- 1 Using the Controller backup functions (i.e., SD Memory Card backup function or the Sysmac Studio Controller backups), back up the settings data other than the server certificate in the CPU Unit to the SD Memory Card or the computer as a backup file.
- 2 Remove the SD Memory Card and insert it into the newly-installed CPU Unit.
- 3 Using the Controller restore functions (i.e., SD Memory Card restore function or the Sysmac Studio Controller backups), restore the backed-up file to the new CPU Unit*1.
*1. You can select whether to restore the OPC UA security profile (i.e., client certificate, CA certificate, Certificate Revocation List, Security Settings) in the target data.
- 4 Cycle the power supply to the new CPU Unit, or reset the Controller.
A new server certificate will be automatically generated.

If the newly-installed CPU Unit has ever used the OPC UA Server, a *Server Certificate Mismatch* event (event code: 15020000 hex) may be registered in the event log. If it is registered, connect online to the CPU Unit and regenerate a server certificate in the **Server Certificate** Tab Page.

- 5** Connect online to the new CPU Unit from the Sysmac Studio, right-click **OPC UA Server Settings**, and then click the **Export** Button in the **Server Certificate** Tab Page to export the server certificate.
- 6** Import the exported X.509 certificate file to the OPC UA client.
- 7** If you have not restored the OPC UA security profile, connect online to the new CPU Unit from the Sysmac Studio and reconfigure the security settings, the client certificate, and if necessary the CA certificate and Certificate Revocation List.

8-3 Clear All Memory Function Related to the OPC UA Server

This section describes the function for clearing all memory in the NJ/NX-series CPU Unit from the Sysmac Studio that is related to the OPC UA Server.

Clear All Memory is an operation to initialize the data in the CPU Unit from the Sysmac Studio. The following table shows whether or not each data of the OPC UA Server is target for the Clear All Memory function.

Data		To be cleared or not
OPC UA Server Settings		Cleared
Server Certificate		Whether cleared or not cleared can be selected
OPC UA security profile	Client certificates, CA certificates, and Certificate Revocation List	
	Security settings (user authentication settings, anonymous login, and security policy)	
Execution Logs		Not cleared

The Sysmac Studio Operation

The Clear All Memory operation can be performed on the Sysmac Studio only when the Controller is in PROGRAM mode. Before you clear All Memory, change the operating mode of the Controller to PROGRAM mode.

- 1 Connect the Sysmac Studio to the CPU Unit online, and select **Clear All Memory** from the **Controller Menu**. The following **Clear All Memory** Dialog Box is displayed.

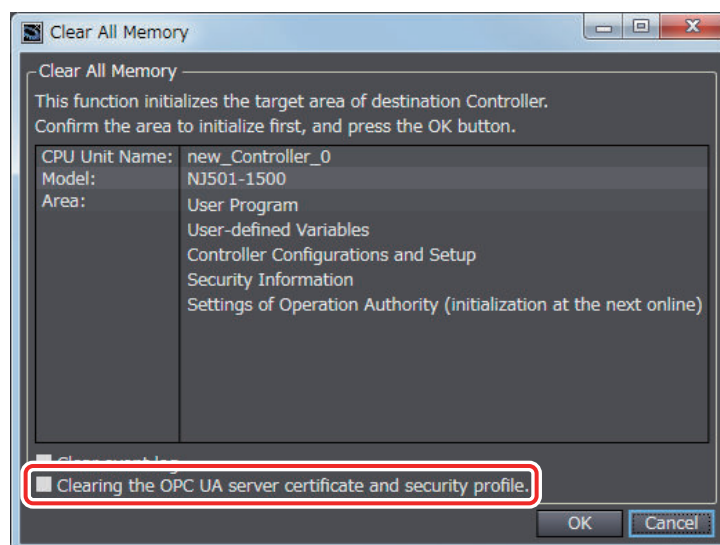

- 2 Select the following check box as needed.

Check box	Description
Clearing the OPC UA server certificate and security profile.	If you select this check box, the <i>OPC UA server certificate</i> and <i>OPC UA security profile</i> are cleared. If you deselect this check box, the <i>OPC UA server certificate</i> and <i>OPC UA security profile</i> are not cleared.

3 Click the **OK** Button. The following dialog box is displayed.

- When the **Clearing the OPC UA server certificate and security profile** Check Box is selected

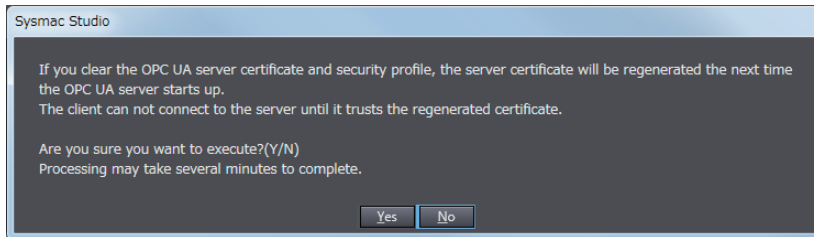

- When the **Clearing the OPC UA server certificate and security profile** Check Box is not selected

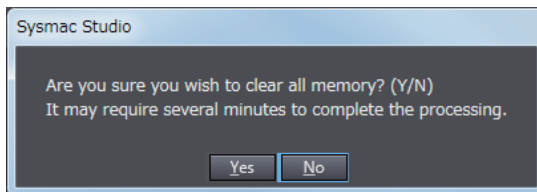

4 Click the **Yes** Button to clear all memory. All memory is cleared.

- When **OPC UA Server** in **OPC UA Server Settings** under **OPC UA Settings** is set to *Use* for the connected CPU Unit:
The Controller must be reset. The following dialog box is displayed.

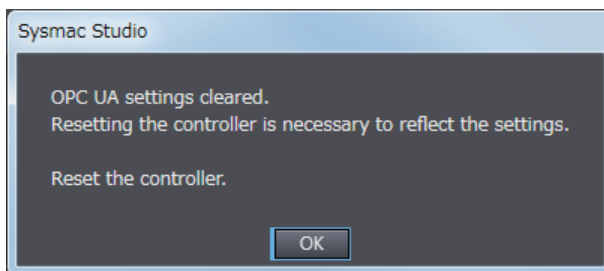

Click the **OK** Button. The Controller reset will be executed.
The following dialog box is displayed.

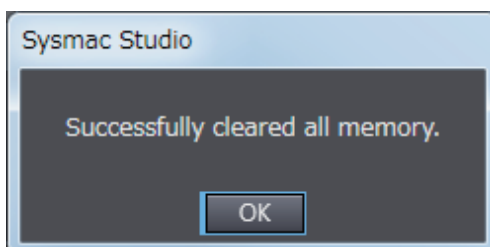

Click the **OK** Button.

- When **OPC UA Server** in **OPC UA Server Settings** under **OPC UA Settings** is set to *Do not use* for the connected CPU Unit:

There is no need to cycle the power supply to the Controller, or reset the Controller. The following dialog box is displayed.

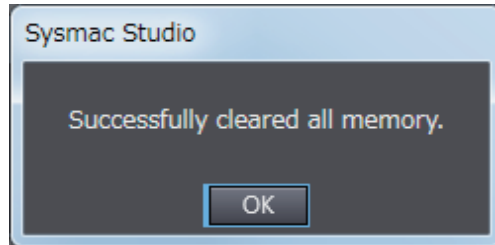

Click the **OK** Button.

Reconfiguring Procedures After Clear All Memory

After Clear All Memory, reconfigure the settings that are related to the OPC UA Server using the following procedures.

● When Not Clearing the Server Certificate And OPC UA Security Profile

- 1** Reconfigure the OPC UA Server Settings offline from the Sysmac Studio and download them to the CPU Unit.
- 2** Cycle the power supply to the Controller or reset the Controller.

● When Clearing the Server Certificate and OPC UA Security Profile

- 1** Reconfigure the OPC UA Server Settings offline from the Sysmac Studio and download them to the CPU Unit.
- 2** Cycle the power supply to the Controller or reset the Controller.
A server certificate will be created automatically.
- 3** Connect online from the Sysmac Studio to the CPU Unit, and set the Security Settings, client certificate, and if necessary the CA certificate and Certificate Revocation List.
- 4** Connect online from the Sysmac Studio to the CPU Unit, and click the **Export** Button in the **Server Certificate** Tab Page to export the server certificate.
- 5** Import the exported server certificate (X.509 certificate file) to the OPC UA client.

9

Troubleshooting

This section describes the overview of methods for checking errors.

9-1	Overview of Troubleshooting.....	9-2
------------	---	------------

9-1 Overview of Troubleshooting

You manage all of the errors that occur on the NJ/NX-series Controller as events.

This allows you to see what errors have occurred and find corrections for them with the same methods for the entire range of errors that is managed (i.e., CPU Unit, NX Units, NX-series Slave Terminals, EtherCAT slaves*¹, and CJ-series Units).

*1. Only the Sysmac devices are supported.

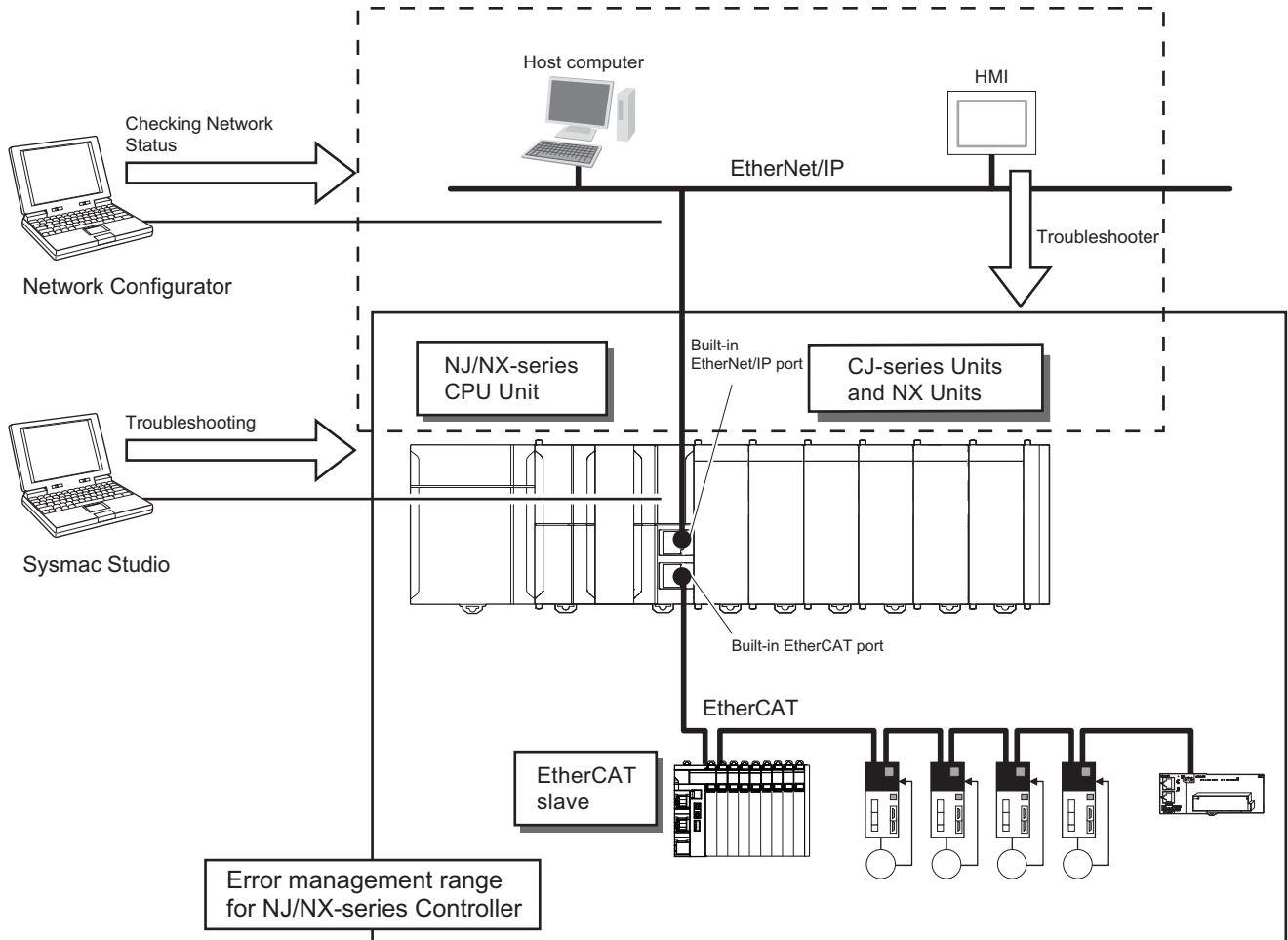

You can use the troubleshooting functions of the Sysmac Studio or the Troubleshooter on an HMI to quickly check for errors that have occurred and find corrections for them.

Refer to the *NJ/NX-series Troubleshooting Manual (Cat. No. W503)* for types of errors, meanings, specific corrections when errors occur and for troubleshooting information on the entire NJ/NX-series Controller.



Appendices

This section describes the error confirmation methods and corrections for errors that can occur with the OPC UA Server.

A-1	Task Design Procedure.....	A-2
A-1-1	Startup Time of the OPC UA Server (Reference Values).....	A-2
A-1-2	Guidelines for System Service Execution Time Ratio	A-6
A-1-3	Checking the System Service Execution Time Ratio	A-7
A-2	OPC UA Instructions.....	A-9
A-2-1	OPCUA_Shutdown (Shutdown OPC UA Function).....	A-9
A-2-2	Variables.....	A-9
A-2-3	Related System-defined Variables	A-10
A-2-4	Related Error Codes.....	A-10
A-2-5	Function.....	A-10
A-2-6	Precautions for Correct Use	A-10
A-2-7	Additional Information.....	A-11
A-2-8	Sample Programming.....	A-11
A-3	When CA-signed Client Certificates Supported	A-14
A-3-1	Overview	A-14
A-3-2	Setting	A-15
A-3-3	Related Operations Performed from OPC UA Settings in the Sysmac Studio	A-15
A-4	List of Related System-defined Variables	A-20
A-4-1	System-defined Variables for the Overall NJ/NX-series Controller (No Category).....	A-20
A-5	Support for OPC UA for PackML Specifications	A-21
A-5-1	Range of Compatible OPC UA for PackML Specifications	A-21
A-5-2	What You Need When Using OPC UA for PackML.....	A-21
A-5-3	OPC UA for PackML Information Model.....	A-21
A-6	Version Information	A-27
A-6-1	Relationship between Unit Versions and OPC UA Standard Versions.....	A-27
A-6-2	Relationship between Unit Versions and the Sysmac Studio Versions	A-27

A-1 Task Design Procedure

This section describes the task design procedure for the OPC UA Server.

Refer to the *NJ/NX-series CPU Unit Software User's Manual (Cat. No. W501)* for the task and system service operation specifications of the NJ/NX-series Controllers.

A-1-1 Startup Time of the OPC UA Server (Reference Values)

The time required to get the OPC UA Server ready for operation after turning ON the power of the CPU Unit (hereinafter called "startup time") varies depending on the number of network-published variables and the task execution time ratio.

The following graphs show reference values given when the data type of all network-published variables is INT type.

Please design your system by reference to these graphs.

NX701-1□□□

● Change in Startup Time Depending on Number of Network-published Variables

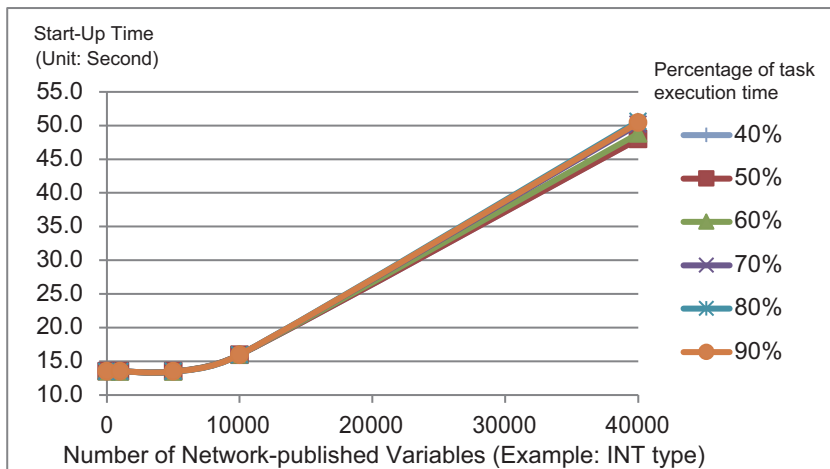

● **Change in Startup Time Depending on Task Execution Time Ratio**

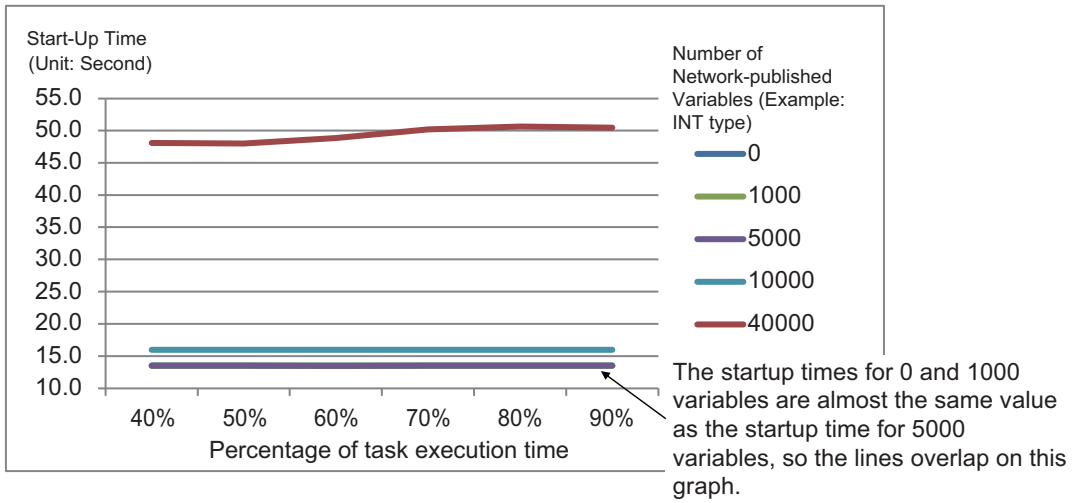

NX502-1□00

● **Change in Startup Time Depending on Number of Network-published Variables**

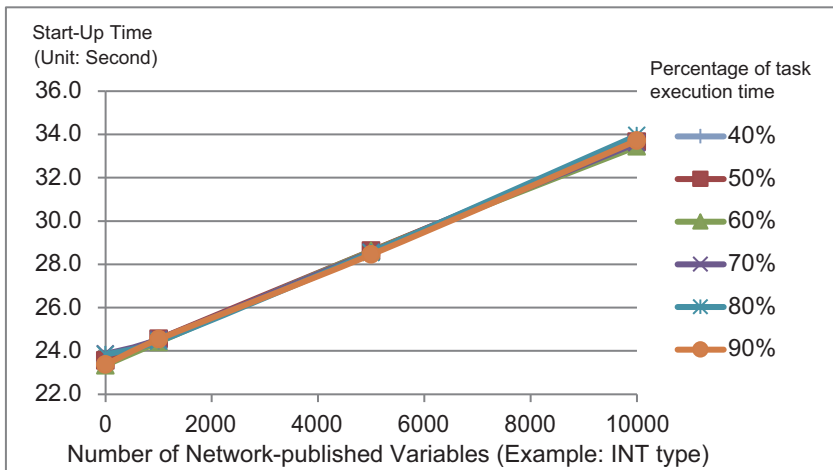

● **Change in Startup Time Depending on Task Execution Time Ratio**

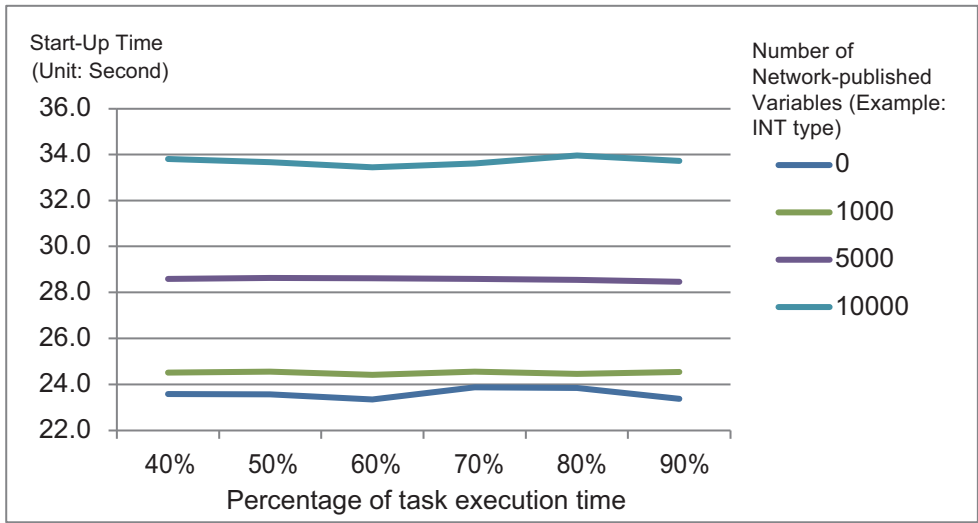

NJ501-1□00

● **Change in Startup Time Depending on Number of Network-published Variables**

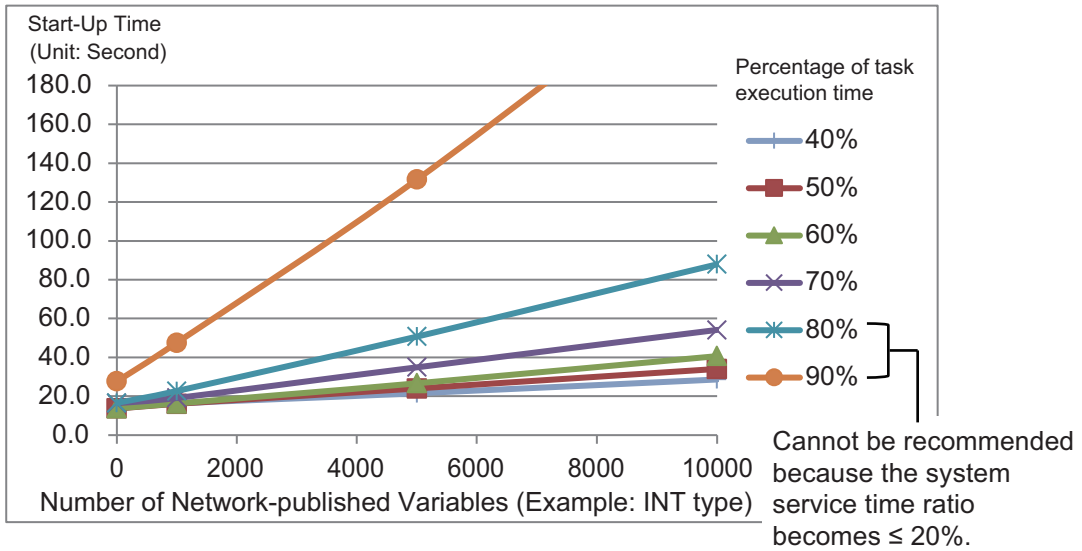

● Change in Startup Time Depending on Task Execution Time Ratio

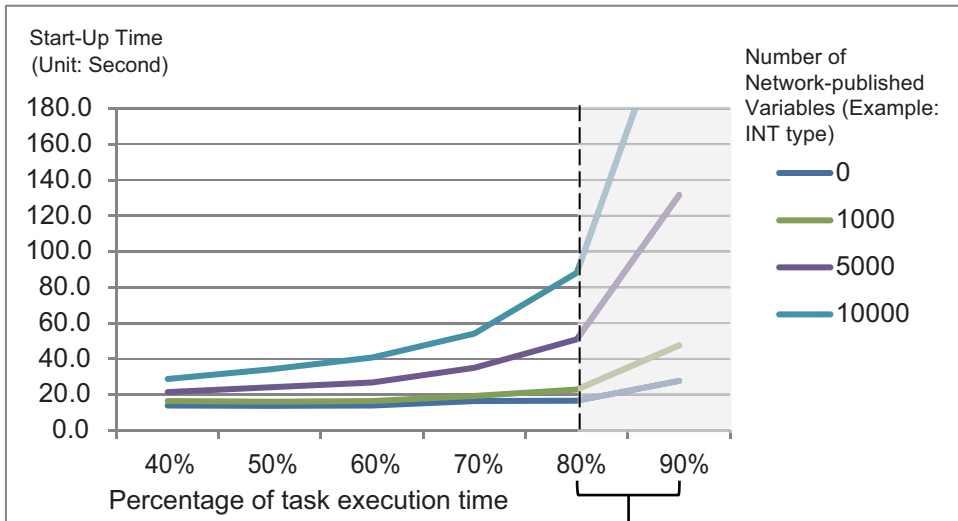

Cannot be recommended because the system service time ratio becomes $\leq 20\%$.

NX102-□□□□

● Change in Startup Time Depending on Number of Network-published Variables

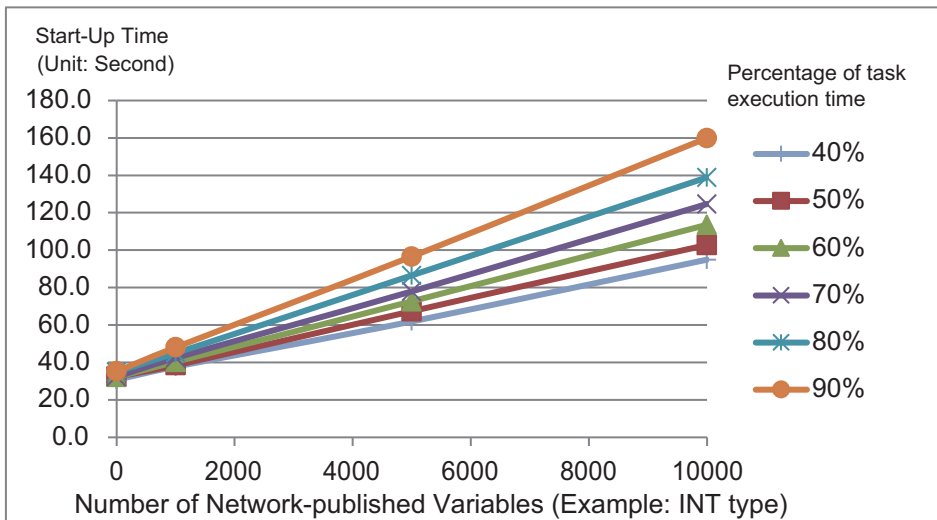

● **Change in Startup Time Depending on Task Execution Time Ratio**

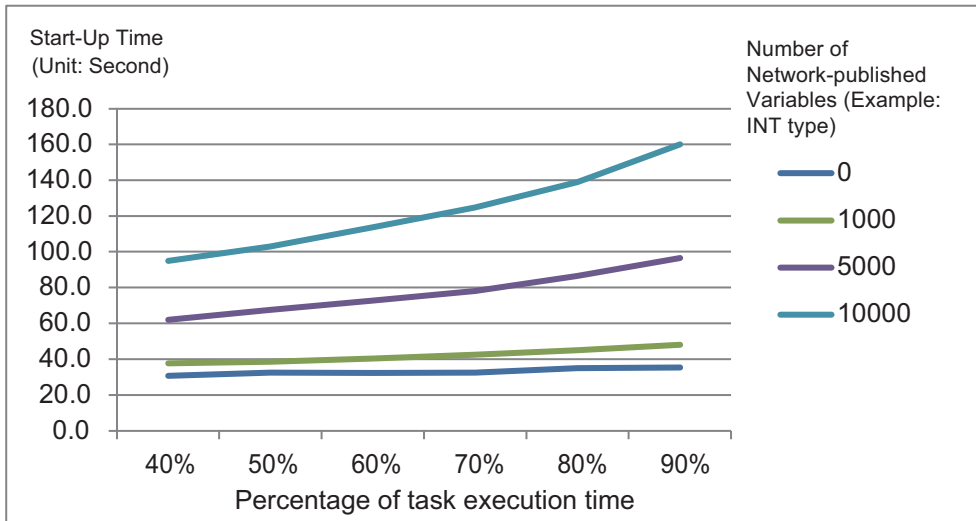

Precautions for Correct Use

The OPC UA Server is executed as a system service. Accordingly, if other system services are executed while the OPC UA Server is starting up, they may take longer.

A-1-2 Guidelines for System Service Execution Time Ratio

The OPC UA Server is executed as a system service.

When the OPC UA Server is used, the OPC UA Server executes the processing as a system service. The method of executing the system service depends on the CPU Unit model.

● **NJ501-1□00**

For NJ501-1□00, if sufficient system service execution time cannot be secured, the OPC UA Server may be slow in responding to requests from OPC UA clients, including reading/writing variables. As a target to perform a satisfactory level of response to requests from OPC UA clients, design tasks to make sure that the system service execution time ratio exceeds 20%.



Precautions for Safe Use

The system service execution time ratio (CPU usage) of 20% or greater is just a numerical target. The appropriate system service execution time ratio depends on the CPU usage of other services executed on the system.

Before starting actual operation, you must test performance under all foreseeable conditions on the actual system and make sure that the OPC UA Server operates with appropriate system service execution time.



Precautions for Correct Use

- If the system service execution time ratio is reduced, operation failures or communications errors may occur when each operation is executed from the Sysmac Studio. If an operation failure or communications error occurs when you execute an operation from the Sysmac Studio, retry the operation after doing the following:
 - a) Check the cable connections.
 - b) Check the communications settings.
 - c) Increase the response monitoring time in the communications settings.
 - d) Start up in safe mode.
- If the Sysmac Studio cannot go online, refer to the *NJ/NX-series Troubleshooting Manual (Cat. No. W503)*.
- If the time set for system service monitoring cannot be secured for system services, an *Insufficient System Service Time Error* will occur. The error is classified as a major fault level Controller error. When the error occurs, user programs will be stopped. Set the System Service Monitoring Settings to the minimum values that are required to meet the response performance of the system services so that sufficient time can be allocated to the system services and task execution. The System Service Monitoring Settings are used to monitor whether the specified system service execution time can be obtained. System services will not necessarily be executed for the specified time.
- The system service execution time is affected by task execution time and tag data links. Refer to the *NJ/NX-series CPU Unit Software User's Manual (Cat. No. W501)* for details of task specifications, tag data link service, and system services.

● NX701-1□□□ and NX502-1□00

For NX701 and NX502 CPU Units, the system services are executed at the required time without being affected by the task and tag data link service. It is designed to always secure sufficient time for system service execution.

● NX102-□□□□

For NX102-□□□□, the system services are executed without being affected by the tasks. However, during execution of the tag data link service, system services are not executed.

A-1-3 Checking the System Service Execution Time Ratio

When you design tasks, confirm that sufficient execution time can be allocated to system services by the following methods.

● Desktop Calculation

This is an example for a project that consists of one primary periodic task.

Refer to the *NJ/NX-series CPU Unit Software User's Manual (Cat. No. W501)* to make a rough estimate of the *average task execution time* on paper.

- For NJ501-1□00

Average task execution time < *Task period* x 0.8

Design the task based on the above calculation.

● Calculating with the Simulator in the Sysmac Studio

Check the value of *Estimated CPU usage rate* with the *Task Execution Time Monitor* for the Simulator on the Sysmac Studio.

Refer to the *NJ/NX-series CPU Unit Software User's Manual (Cat. No. W501)* for the procedure to check the operation on the Simulator.

- For NJ501-1□00
 $Estimated\ CPU\ usage\ rate - System\ service\ execution\ time\ ratio < 80\%$
 Design the task based on the above calculation.

The *Estimated CPU usage rate* shows how much of the task period is used by the total of the maximum estimated task processing time, the tag data link service execution time ratio, and the system service processing time.

The value obtained by subtracting the *System service execution time ratio* from the *Estimated CPU usage rate* is the percentage for the execution time of processing other than system services.

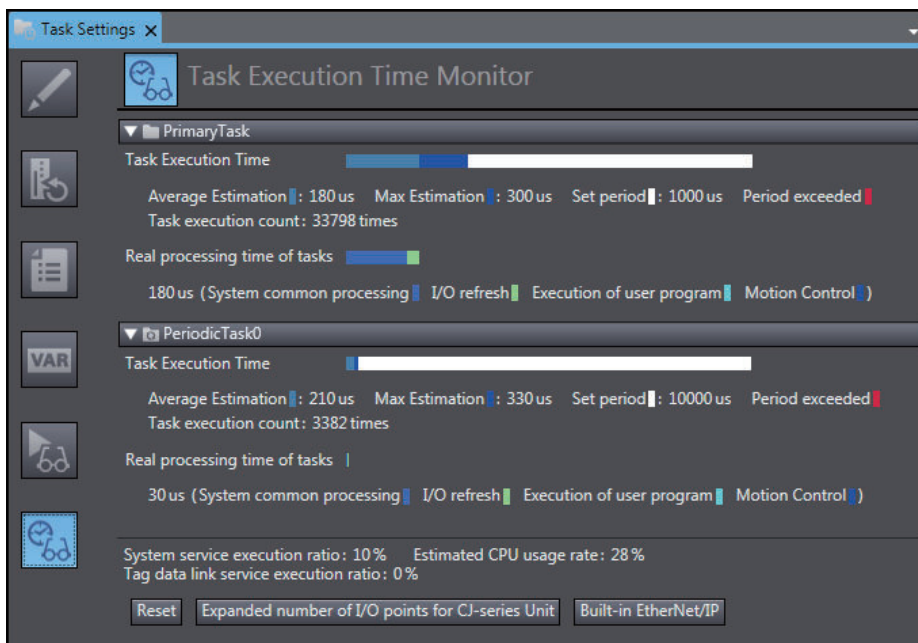

● Calculating Times on the Actual Controller

When the project consists of one primary periodic task, check the *average task execution time* using the *Task Execution Time Monitor function* on the Sysmac Studio connected online with the actual Controller.

- For NJ501-1□00
 $Average\ task\ execution\ time < Task\ period \times 0.8$
 Design the task based on the above calculation.

When the project consists of multiple tasks, test the performance under all foreseeable conditions using the actual Controller to make sure that the OPC UA clients operate within the appropriate execution time.

A-2 OPC UA Instructions

This section describes the OPC UA instructions.

Refer to the *NJ/NX-series Instructions Reference Manual (Cat. No. W502)* for details on the variables common to the NJ/NX-series instructions.

A-2-1 OPCUA_Shutdown (Shutdown OPC UA Function)

The OPCUA_Shutdown (Shutdown OPC UA Function) instruction requests the termination of the OPC UA functions so that the Controller power supply can be safely turned OFF.

Instruction	Name	FB/ FUN	Graphic expression	ST expression
OP- CUA_Shut- down	Shutdown OPC UA Server	FB		OPCUA_Shutdown_instance (Execute, Done, Busy, Error, Er- rorID);

Note The OPCUA_Shutdown_instance is an instance of OPCUA_Shutdown (Shutdown OPC UA Function) instruction, which is declared as a variable.

A-2-2 Variables

Input Variables

Input variable	Meaning	Data type	Valid range	Unit	Default	Description
Execute	Execute	BOOL	TRUE or FALSE	---	FALSE	Specify the execution condition.

Output Variables

Output variable	Meaning	Data type	Valid range	Unit	Description
Done	Done	BOOL	TRUE or FALSE	---	TRUE when the instruction is normally completed.
Busy	Executing	BOOL	TRUE or FALSE	---	TRUE when the instruction is being executed.
Error	Error	BOOL	TRUE or FALSE	---	TRUE when the instruction is terminated due to an error.
ErrorID	Error Code	WORD	16#0000 to 16#FFFF	---	Contains the error code when an error occurs.

A-2-3 Related System-defined Variables

None

A-2-4 Related Error Codes

Error code	Error name	Description
16# 041D	Too Many Instructions Executed at the Same Time	More than 32 OPC UA instructions were executed at the same time.
16# 5000	OPC UA Server Shutdown or Shutting Down	The instruction was executed after the OPC UA Server was shut down or while the OPC UA Server was being shut down.
16# 5001	OPC UA Server Being Initialized	The instruction cannot be executed because the OPC UA Server is being initialized.
16# 5002	OPC UA Server Not Started	The instruction was executed while the <i>Do not use</i> Option was selected for the OPC UA Server.

For details on errors, refer to the *OPC UA Instructions* in the *NJ/NX-series Troubleshooting Manual (Cat. No. W503)*.

A-2-5 Function

The OPCUA_Shutdown (Shutdown OPC UA Function) instruction requests the shutdown of the OPC UA Server so that the Controller power supply can be safely turned OFF.

At this time, in order to set the OPC UA Server to the shutdown state, record *OPC UA server shutdown completed* in the Execution Log, and stop access to the SD Memory Card.

Before turning OFF the power supply to the Controller, make sure this instruction has terminated normally (the value of *Done* has changed to TRUE).

This instruction operates separately from the function of accessing the SD Memory Card for other instructions. If other than the OPC UA Server accesses the SD Memory Card during the execution of this instruction, this instruction will be executed asynchronously with respect to the SD Memory Card access, and therefore, the processing order will be optional.

A-2-6 Precautions for Correct Use

- Execution of this instruction is continued until processing is completed even if the value of *Execute* changes to FALSE or the execution time exceeds the task period. You can confirm that the processing normally ends by checking that the value of *Done* has changed to TRUE.
- Refer to *Using this Section* of the *NJ/NX-series Instructions Reference Manual (Cat. No. W502)* for a timing chart for *Execute*, *Done*, *Busy*, and *Error*.
- This instruction cannot be used on an event task. A compiling error will occur.
- OPC UA instructions cannot be executed during and after execution of this instruction. The execution of an OPC UA instruction will result in an error.
- Before turning OFF the power supply to the system, make sure this instruction has terminated normally by confirming that the value of *Done* has changed to TRUE.
- If the power supply is turned OFF without executing this instruction, the Execution Log will not be saved correctly.

A-2-7 Additional Information

If this instruction is executed on the simulator, no processing is performed, and the output variables are as shown below.

Output variable	Meaning	Data type	Execution results
Done	Done	BOOL	TRUE
Busy	Executing	BOOL	FALSE
Error	Error	BOOL	FALSE
ErrorID	Error Code	WORD	16#0000

A-2-8 Sample Programming

This section gives sample programming for shutting down the OPC UA Server when the trigger variable changes to TRUE.

Ladder Diagram

● Main Variables

Name	Data type	Initial value	Comment
OPCUA_Shutdown_instance	OPCUA_Shutdown	---	Instance of OPCUA_Shutdown (Shutdown OPC UA Function) instruction.
Trigger	BOOL	FALSE	Variable used as a trigger for shutting down the OPC UA Server.
Shutdown_OK	BOOL	FALSE	This variable changes to TRUE when the OPCUA_Shutdown (Shutdown OPC UA Function) instruction terminates normally.

● Sample Programming

- Shutdown the OPC UA Server.
Shutdown the OPC UA server by setting Trigger to TRUE.

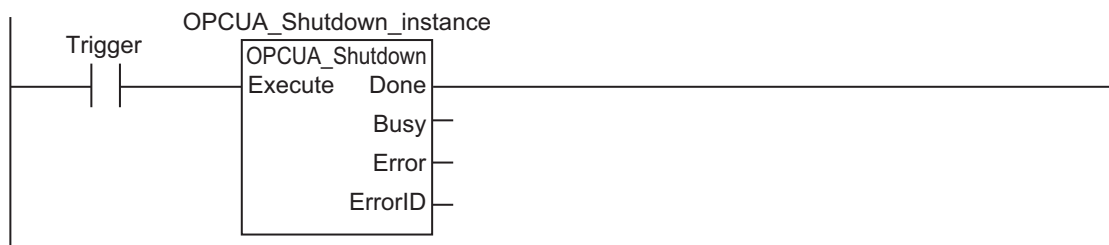

When the instruction is normally completed, the Shutdown_OK variable is changed to TRUE.



Structured Text (ST)

● Main Variables

Name	Data type	Initial value	Comment
OPCUA_Shutdown_instance	OPCUA_Shutdown	---	Instance of OPCUA_Shutdown (Shutdown OPC UA Function) instruction.
Trigger	BOOL	FALSE	Variable used as a trigger for shutting down the OPC UA Server.
LastTrigger	BOOL	FALSE	Variable to retain the trigger status of the previous execution.
Operating	BOOL	FALSE	The OPC UA Server is shutdown when this variable is TRUE.
OperatingStart	BOOL	FALSE	The initialization processing is executed when this variable is TRUE.
ShutdownOK	BOOL	FALSE	This variable changes to TRUE when the OPCUA_Shutdown (Shutdown OPC UA Function) instruction terminates normally.

● Sample Programming

```
(*-----
Shutdown the OPC UA Server.
-----*)

// Start the sequence when the variable Trigger changes to TRUE.
IF ( (Trigger=TRUE) AND (LastTrigger=FALSE) ) THEN
    OperatingStart := TRUE;
    Operating := TRUE;
END_IF;
LastTrigger := Trigger;

// Sequence start processing
IF (OperatingStart=TRUE) THEN
    // Initialize the instruction instance.
    OPCUA_Shutdown_instance( Execute:=FALSE );

    OperatingStart := FALSE;
END_IF;

IF(Operating=TRUE) THEN
    // Shutdown OPC UA Server
    OPCUA_Shutdown_instance( Execute:=TRUE );
```

```
IF (OPCUA_Shutdown_instance.Done=TRUE) THEN
  // Normal end processing
  ShutdownOK := TRUE;
  Operating := FALSE;
END_IF;
IF (OPCUA_Shutdown_instance.Error=TRUE) THEN
  // Processing after error end
  Operating := FALSE;
END_IF;
END_IF;
```

A-3 When CA-signed Client Certificates Supported

This section describes an overview and settings of a CA-signed client certificate, as well as how to operate a CA-signed client certificate on the Sysmac Studio.

A-3-1 Overview

For a CA-signed client certificate, you must make the settings from the **Client Authentication** Tab Page and the **Issuer Authentication** Tab Page in the OPC UA Settings (online) from the Sysmac Studio.

The internal mechanism of the CPU Unit is as shown below.

Note that both the CA-signed client certificate and the self-signed client certificate can also be used together*1.

*1. Shown by a dotted line in the following diagram.

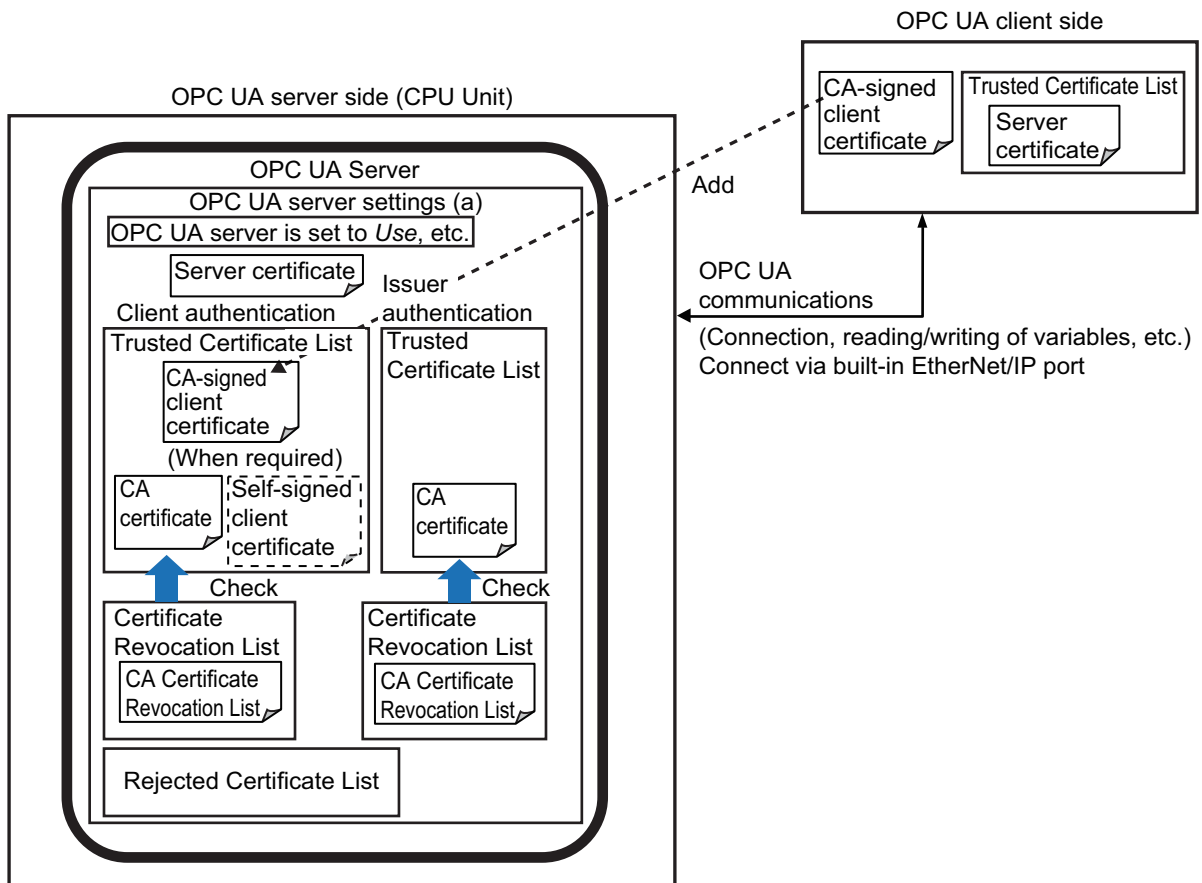

The CA Certificate Revocation List is a list in which issued client certificates are registered when they are revoked before the expiry of the valid period.

If a client certificate is registered in the CA Certificate Revocation List, the connection from the corresponding client certificate fails, and the client certificate is registered in the Rejected Certificate List.

A-3-2 Setting

For a CA-signed client certificate, you must make the following settings in the OPC UA Settings (online) from the Sysmac Studio.

The certificates that must be registered differ depending on the authentication means and the type of CA certificate.

Authentication means of CA-signed client certificate	Type of corresponding CA certificate a	OPC UA Settings (online)				
		Client Authentication Tab Page		Issuer Authentication Tab Page		
		Trusted certificate	Certificate Revocation List	Trusted certificate	Certificate Revocation List	
When authentication is performed only by the CA certificate (CA Certificate a) that signs the client certificate	A root certificate	Register only the CA certificate a	Register the revocation list containing the CA certificate a	Registration not required	Registration not required	
	An intermediate certificate			Register all CA certificates up to the root certificate	Register the group of revocation lists containing all CA certificates specified on the left	
When authentication is performed by the client certificate (Client Certificate b) and the CA certificate (CA Certificate a) that signs the client certificate	A root certificate	Register both certificates below: <ul style="list-style-type: none"> • Corresponding client certificate b • Corresponding CA certificate a 	Register the revocation list containing the CA certificate a	Registration not required	Registration not required	
	An intermediate certificate			Register all CA certificates up to the root certificate, except the CA certificate a	Register the group of revocation lists containing all CA certificates specified on the left	
	Or					
		A root certificate	Register only the client certificate b	Registration not required	Register the root certificate	Register the revocation list containing the root certificate
	An intermediate certificate	Registration not required		Register all CA certificates up to the root certificate including the CA certificate a	Register the group of revocation lists containing all CA certificates specified on the left	

A-3-3 Related Operations Performed from OPC UA Settings in the Sysmac Studio

For a CA-signed client certificate, make the following settings from **Client Authentication** and **Issuer Authentication** in the **OPC UA Settings** of the Sysmac Studio.

Client Authentication

Display and perform client authentication for a CPU Unit connected online.



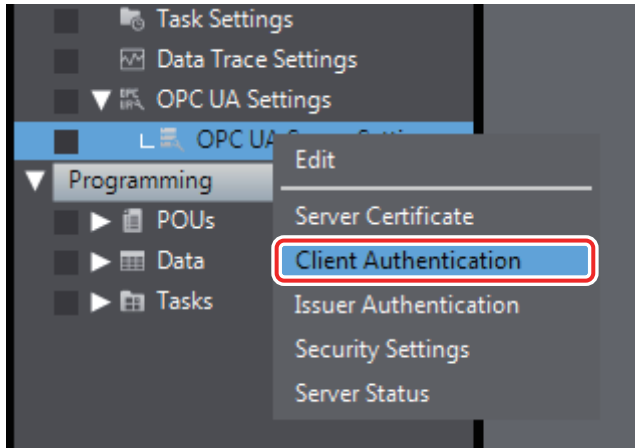

- 1 Place the Sysmac Studio online with the CPU Unit, right-click **OPC UA Server Settings** under **Configurations and Setup - OPC UA Settings** in the Multiview Explorer, and then select **Client Authentication**.

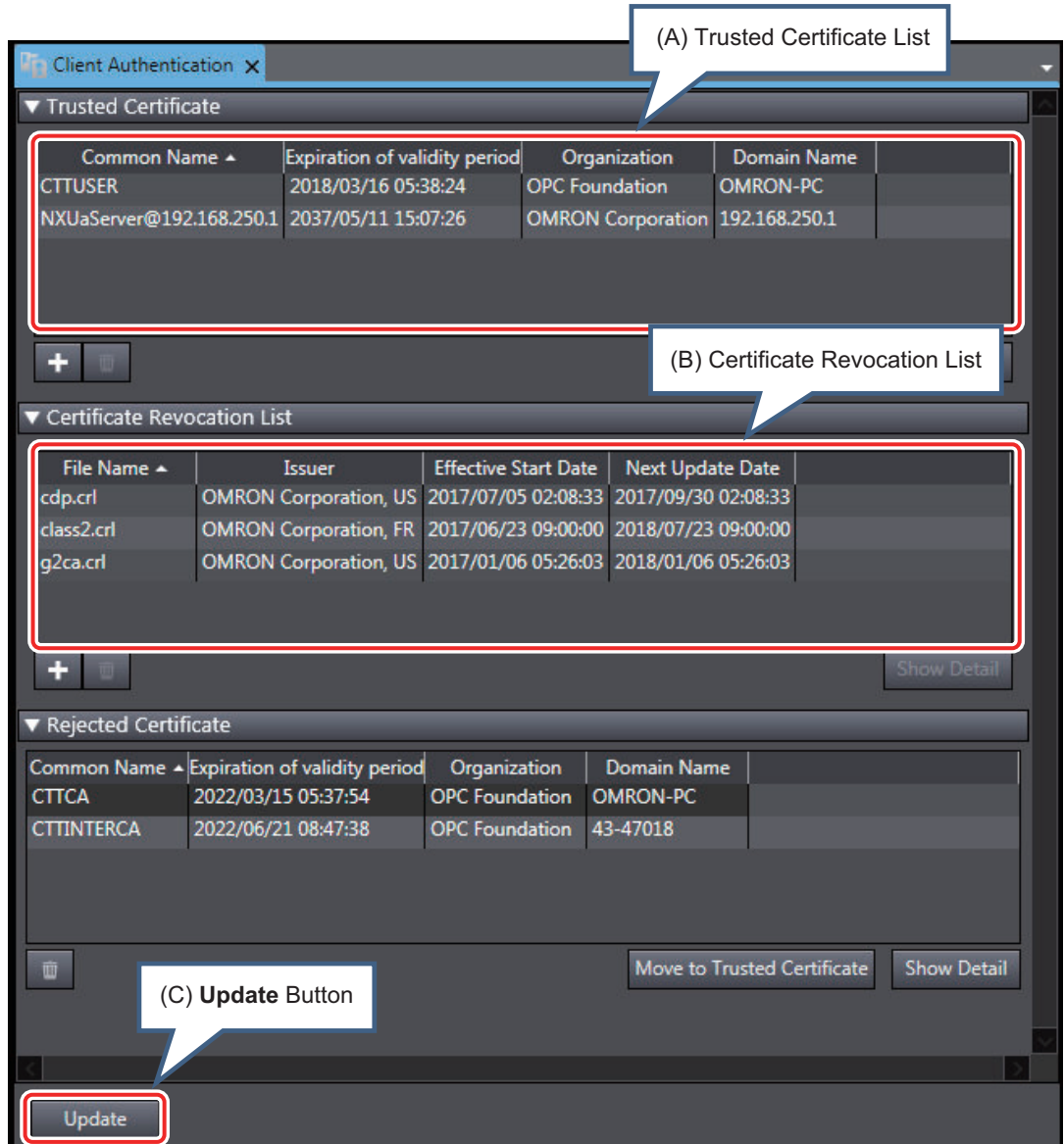

The following **Client Authentication** Tab Page appears.



The following information is displayed.

Item	Description
(A) Trusted Certificate List	<p>The Trusted Client Certificate List in the CPU Unit is displayed.</p> <ul style="list-style-type: none"> • Common name, expiration of validity period, organization, domain name are displayed. • The default display order is ascending order of common names. You can sort the list by the name of each item by clicking each column header. Ascending and descending order are switched each time you click. <hr/> <ul style="list-style-type: none"> • Add Button (): Adds the certificate selected in the Add Certificate Dialog Box to the Trusted Certificate List in the CPU Unit. • Delete Button (): Deletes the selected certificate from the Trusted Certificate List in the CPU Unit.
(B) Certificate Revocation List	<p>The Certificate Revocation List in the CPU Unit is displayed.</p> <ul style="list-style-type: none"> • The File Name, Issuer, Effective Start Date, and Next Update Date are displayed. • The default display order is the ascending order of the file name. You can sort the list by the name of each item by clicking each column header. Ascending and descending order are switched each time you click. <hr/> <ul style="list-style-type: none"> • Add Button (): Adds the certificate selected in the Add Certificate Dialog Box to the Trusted Certificate List in the CPU Unit. • Delete Button (): Deletes the selected certificate from the Trusted Certificate List in the CPU Unit.
(C) Update Button	The display in the Client Authentication Tab Page is updated with the data in the CPU Unit.

Issuer Authentication

Perform display and operations of issuer authentication in the CPU Unit placed online.

- 1 Place the Sysmac Studio online with the CPU Unit, right-click **OPC UA Server Settings** under **Configurations and Setup - OPC UA Settings** in the Multiview Explorer, and then select **Issuer Authentication**.

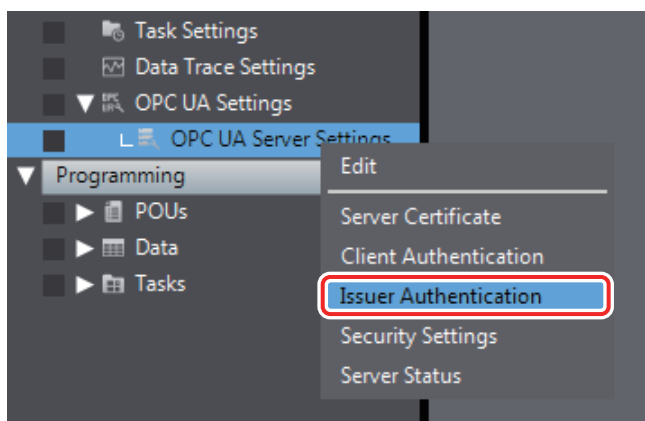

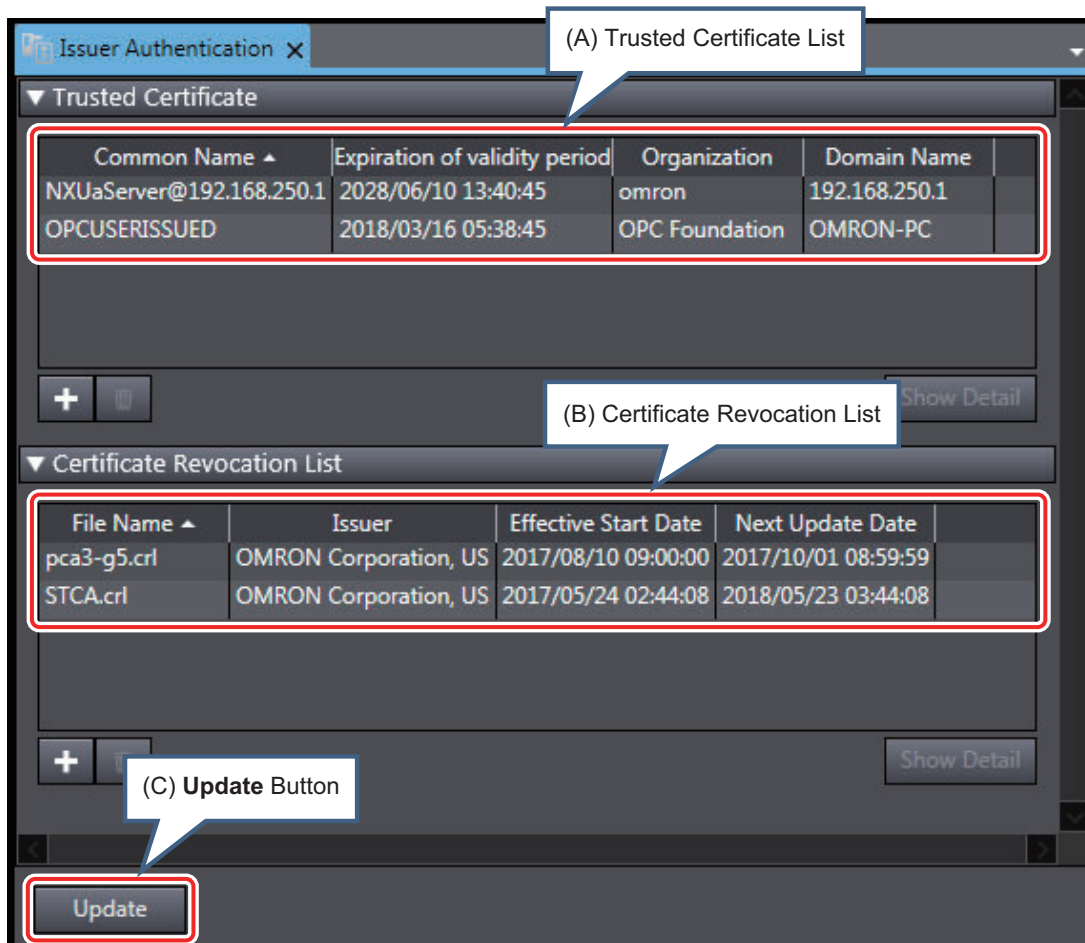

The following **Issuer Authentication** Tab Page is displayed.



The following information is displayed.

Item	Description
(A) Trusted Certificate List	<p>The Trusted CA Certificate List in the CPU Unit is displayed.</p> <ul style="list-style-type: none"> • Common name, expiration of validity period, organization, domain name are displayed. • The default display order is ascending order of common names. You can sort the list by the name of each item by clicking each column header. Ascending and descending order are switched each time you click.
(B) Certificate Revocation List	<p>The Certificate Revocation List in the CPU Unit is displayed.</p> <ul style="list-style-type: none"> • The File Name, Issuer, Effective Start Date, and Next Update Date are displayed. • The default display order is the ascending order of the file name. You can sort the list by the name of each item by clicking each column header. Ascending and descending order are switched each time you click.



Item	Description
	<ul style="list-style-type: none"> <li data-bbox="638 264 1463 376">• Add Button (): Adds the certificate selected in the Add Certificate Dialog Box to the Trusted Certificate List in the CPU Unit. <li data-bbox="638 387 1463 499">• Delete Button (): Deletes the selected certificate from the Trusted Certificate List in the CPU Unit.
(C) Update Button	The display in the Issuer Authentication Tab Page is updated with the data in the CPU Unit.

A-4 List of Related System-defined Variables

This section lists the system-defined variables related to the OPC UA Server.

A-4-1 System-defined Variables for the Overall NJ/NX-series Controller (No Category)

- **Functional Classification: SD Memory Card Related**

Variable name	Name	Function	Data type	Range of values
_Card1RestoreCmd-TargetOpcuaSPF	OPC UA Security Profile Transfer Flag	When restoring <i>OPC UA security profile</i> in the SD Memory Card to the Controller, set this to TRUE.	BOOL	TRUE, FALSE

A-5 Support for OPC UA for PackML Specifications

The unit versions of the following CPU Units support to the OPC UA for PackML 1.01 specifications.

NJ501-1□□00: Version 1.62 or later

NX102-□□□□: Version 1.64 or later

NX502-1□□00: Version 1.64 or later

NX701-1□□□: Version 1.34 or later

A-5-1 Range of Compatible OPC UA for PackML Specifications

It supports the Mandatory and Optional items in the OPC UA for PackML specifications.

Vendors have the following specifications.

- Total time reset

The following are not supported.

- Function to use the OPC UA client function
- RemoteCommand

OPC UA server already supports Mandatory and Optional items. Therefore, if it does not support Optional items as a user program, provide the information to the OPC UA client as necessary.

Refer to *A-5-3 OPC UA for PackML Information Model* on page A-21 for details.

A-5-2 What You Need When Using OPC UA for PackML

In addition to the Controller and Sysmac Studio, the following are required when you use OPC UA for PackML.

Item	Description
Sysmac Library OPC UA PackML Library (SYSMAC-XR101)	By simply introducing this library, it is possible to support the OPC UA for PackML specifications without being aware of the details of the OPC UA for PackML specifications. In addition to function blocks for using OPC UA for PackML, Omron's OPC UA for PackML information model and an internal Method FB to call function blocks for the Sysmac Library with the OPC UA Method function are also included. Refer to the <i>Sysmac Library for OPC UA PackML Library User's Manual (Cat. No. W638)</i> for details on the OPC UA PackML library.

A-5-3 OPC UA for PackML Information Model

A list of OPC UA for PackML Information Model is shown below.

OPC UA node
PMLBaseObjType_instance
Admin
AccTimeSinceReset

OPC UA node
Alarm
AckDateTime
Category
DateTime
ID
Message
Trigger
Value
AlarmExtent
AlarmHistory
AckDateTime
Category
DateTime
ID
Message
Trigger
Value
AlarmHistoryExtent
MachDesignSpeed
ModeCumulativeTime
ModeCurrentTime
Parameter
ID
Name
Unit
Description
DisplayName
NamespaceUri
UnitId
Value
ProdConsumedCount
AccCount
Count
ID
Name
Unit
Description
DisplayName
NamespaceUri
UnitId
ProdDefectiveCount
AccCount
Count
ID
Name
Unit
Description

OPC UA node
DisplayName
NamespaceUri
UnitId
ProdProcessedCount
AccCount
Count
ID
Name
Unit
Description
DisplayName
NamespaceUri
UnitId
StateCumulativeTime
StateCurrentTime
StopReason
AckDateTime
Category
DateTime
ID
Message
Trigger
Value
StopReasonExtent
Warning
AckDateTime
Category
DateTime
ID
Message
Trigger
Value
WarningExtent
BaseStateMachine
Abort
AvailableStates
AvailableTransitions
Clear
CurrentState
EffectiveDisplayName
Id
Name
Number
LastTransition
EffectiveTransitionTime
Id
Name

OPC UA node	
Number	
TransitionTime	
MachineState	
AvailableStates	
AvailableTransitions	
CurrentState	
EffectiveDisplayName	
Id	
Name	
Number	
ExecuteState	
AvailableStates	
AvailableTransitions	
CurrentState	
EffectiveDisplayName	
Id	
Name	
Number	
Hold	
LastTransition	
EffectiveTransitionTime	
Id	
Name	
Number	
TransitionTime	
Reset	
Start	
InputArguments	
Suspend	
ToComplete	
Unhold	
Unsuspend	
LastTransition	
EffectiveTransitionTime	
Id	
Name	
Number	
TransitionTime	
Reset	
Stop	
Enabled	
PackMLVersion	
RemoteCommand* ¹	
InputArguments* ¹	
SetInterlock	
InputArguments	
SetMachSpeed	

OPC UA node	
InputArguments	
SetParameter	
InputArguments	
SetProduct	
InputArguments	
SetUnitMode	
InputArguments	
Status	
CurMachSpeed	
Definition	
EURange	
EngineeringUnits	
InstrumentRange	
ValuePrecision	
EquipmentBlocked	
EquipmentStarved	
MachSpeed	
Definition	
EURange	
EngineeringUnits	
InstrumentRange	
ValuePrecision	
MaterialInterlock	
MaterialInterlocked	
Parameter	
ID	
Name	
Unit	
Description	
DisplayName	
NamespaceUri	
UnitId	
Value	
Product	
Ingredients	
IngredientsID	
Parameter	
ID	
Name	
Unit	
Description	
DisplayName	
NamespaceUri	
UnitId	
Value	
ProcessVariables	
ID	

OPC UA node			
Name			
Unit			
Description			
DisplayName			
NamespaceUri			
UnitId			
Value			
ProductID			
		RemoteParameter* ¹	
		CmdValue* ¹	
		ControlCmdNumber* ¹	
		Number* ¹	
		Parameter* ¹	
		ID* ¹	
		Name* ¹	
		Unit* ¹	
			Description* ¹
			DisplayName* ¹
			NamespaceUri* ¹
			UnitId* ¹
		Value* ¹	
StateChangeInProgress			
StateRequested			
UnitModeChangeInProgress			
UnitModeCurrent			
UnitModeRequested			
UnitSupportedModes			
TagID			

*1. The nodes in the gray row are not supported.

A-6 Version Information

This section describes the relationship between unit versions of CPU Units, OPC UA standard versions, and the Sysmac Studio versions.

A-6-1 Relationship between Unit Versions and OPC UA Standard Versions

The following table gives the relationship between the unit versions of CPU Units and OPC UA standard versions.

- **NX701-1□□□**

Unit version of CPU Unit	OPC UA standard version
Ver.1.34 or later	Ver.1.04
Ver.1.24 or later	Ver.1.03

- **NX502-1□00**

Unit version of CPU Unit	OPC UA standard version
Ver.1.60 or later	Ver.1.03

- **NJ501-1□00**

Unit version of CPU Unit	OPC UA standard version
Ver.1.62 or later	Ver.1.04
Ver.1.43 or later	Ver.1.03
Ver.1.17 or later and earlier than Ver.1.43	Ver.1.02

- **NX102-□□00**

Unit version of CPU Unit	OPC UA standard version
Ver.1.43 or later	Ver.1.03
Ver.1.30 or later and earlier than Ver.1.43	Ver.1.02

- **NX102-□□20**

Unit version of CPU Unit	OPC UA standard version
Ver.1.36 or later	Ver.1.03
Ver.1.30 or later and earlier than Ver.1.36	Ver.1.02

A-6-2 Relationship between Unit Versions and the Sysmac Studio Versions

The following table gives the relationship between the unit versions of CPU Units and the corresponding Sysmac Studio versions.

CPU Unit model	Unit version of CPU Unit	Corresponding version of Sysmac Studio
NX701-1□□□	Ver.1.24 or later	Ver.1.44 or higher

CPU Unit model	Unit version of CPU Unit	Corresponding version of Sysmac Studio
NX502-1□□00	Ver.1.60 or later	Ver.1.54 or higher
NJ501-1□□00	Ver.1.17 or later	Ver.1.21 or higher
NX102-□□□00	Ver.1.30 or later	Ver.1.23 or higher
NX102-□□□20	Ver.1.30 or later	Ver.1.24 or higher



Index

Index

Numerics

_Card1RestoreCmdTargetOpcuaSPF.....A-20

A

address space..... 23, 6-3
 Anonymous login..... 3-26
 application authentication..... 22, 5-2
 authentication based on anonymous..... 5-6
 authentication based on user name and password..... 5-5

B

backup and restore functions..... 8-4
 built-in EtherNet/IP port..... 5

C

CA-signed client certificate.....A-14
 Clear All Memory function..... 8-9
 client authentication..... 22, 3-17
 client certificate..... 22, 5-4
 connecting from the client..... 6-2

D

DeviceState..... 6-4

E

End point..... 22
 End Point Settings..... 3-7
 event..... 23
 event log..... 23
 Execution Log..... 23
 Execution Log Settings..... 3-8

I

Issuer authentication..... 23, 3-24, A-17

L

list of related system-defined variables..... A-20
 list of supported CPU Units..... 1-4

M

message..... 22
 multidimensional array specified structure..... 6-15

N

Network Publish..... 6-9
 Network Publishing Settings..... 3-9
 node..... 23

Node setting..... 3-8
 number of members per struct type variable 6-15
 number of structure definitions that can be published..... 6-13
 number of value attributes..... 6-13

O

OPC UA..... 22
 OPC UA client..... 22
 OPC UA for PackML..... A-21
 OPC UA security mode..... 23
 OPC UA security policy..... 23
 OPC UA security profile..... 23
 OPC UA server..... 22
 OPC UA Server..... 22
 OPCUA_Shutdown (Shutdown OPC UA Function) instruction..... 4-2, A-9
 operation authority verification..... 8-2

P

permitting a rejected client certificate..... 3-22
 port number..... 3-7

R

reading/writing variables..... 6-5
 reading/writing variables from the OPC UA client..... 6-3
 Reserved Words..... 6-17
 restrictions on publishing..... 6-12
 Role Function..... 5-6

S

security policy..... 23, 3-26
 Security Settings..... 23, 3-24
 server certificate..... 22, 3-12, 5-3
 setting IP addresses..... 3-2
 Sign - Aes128Sha256RsaOaep..... 3-26, 5-9
 Sign - Aes256Sha256RsaPss..... 3-26, 5-9
 Sign - Basic128Rsa15..... 3-26, 5-9
 Sign - Basic256..... 3-26, 5-9
 Sign - Basic256Sha256..... 3-26, 5-9
 SignAndEncrypt - Aes128Sha256RsaOaep..... 3-26, 5-10
 SignAndEncrypt - Aes256Sha256RsaPss..... 3-26, 5-10
 SignAndEncrypt - Basic128Rsa15..... 3-26, 5-10
 SignAndEncrypt - Basic256..... 3-26, 5-10
 SignAndEncrypt - Basic256Sha256..... 3-26, 5-10
 specifications of the OPC UA Server..... 1-4
 structure containing a multidimensional array specified structure as a member..... 6-15
 system service execution time ratio..... A-6

T

Trusted Certificate List..... 22

U

use of the OPC UA Server..... 3-3, 3-5, 3-7
User authentication.....22, 5-5
User Authentication Settings..... 3-26

V

value attributes..... 6-5

OMRON Corporation Industrial Automation Company

Kyoto, JAPAN

Contact : www.ia.omron.com

Regional Headquarters

OMRON EUROPE B.V.

Wegalaan 67-69, 2132 JD Hoofddorp
The Netherlands

Tel: (31) 2356-81-300 Fax: (31) 2356-81-388

OMRON ELECTRONICS LLC

2895 Greenspoint Parkway, Suite 200
Hoffman Estates, IL 60169 U.S.A.

Tel: (1) 847-843-7900 Fax: (1) 847-843-7787

OMRON ASIA PACIFIC PTE. LTD.

438B Alexandra Road, #08-01/02 Alexandra
Technopark, Singapore 119968

Tel: (65) 6835-3011 Fax: (65) 6835-3011

OMRON (CHINA) CO., LTD.

Room 2211, Bank of China Tower,
200 Yin Cheng Zhong Road,
PuDong New Area, Shanghai, 200120, China

Tel: (86) 21-6023-0333 Fax: (86) 21-5037-2388

Authorized Distributor:

©OMRON Corporation 2018-2023 All Rights Reserved.
In the interest of product improvement,
specifications are subject to change without notice.

Cat. No. W588-E1-11 1023