

Vision Sensor
FH Series
Vision System

Processing Item Function Reference Manual for 3D Robot Vision

FH-505□
FH-SMDA-GS050B



NOTE

- All rights reserved.
- No part of this publication may be reproduced, stored in a retrieval system, or transmitted, in any form, or by any means, mechanical, electronic, photocopying, recording, or otherwise, without the prior written permission of OMRON.
- No patent liability is assumed with respect to the use of the information contained herein. Moreover, because OMRON is constantly striving to improve its high-quality products, the information contained in this manual is subject to change without notice. Every precaution has been taken in the preparation of this manual. Nevertheless, OMRON assumes no responsibility for errors or omissions.

Neither is any liability assumed for damages resulting from the use of the information contained in this publication.

Trademarks

- Sysmac and SYSMAC are trademarks or registered trademarks of OMRON Corporation in Japan and other countries for OMRON factory automation products.
- This software is based in part on the work of the Independent JPEG Group.
- Microsoft, Windows, Windows Vista, Excel, and Visual Basic are either registered trademarks or trademarks of Microsoft Corporation in the United States and other countries.
- Intel, Core and Pentium are trademarks of Intel Corporation in the U.S. and/or other countries.
- EtherCAT® is registered trademark and patented technology, licensed by Beckhoff Automation GmbH, Germany.
- ODVA, CIP, CompoNet, DeviceNet, and EtherNet/IP are trademarks of ODVA.
- The SD, SDHC, microSD, and microSDHC logos are trademarks of SD-3C, LLC.



- QR Code is a registered trademark of DENSO WAVE INCORPORATED.
- MELSEC is a registered trademarks of Mitsubishi Electric Corporation.

Other company names and product names in this document are the trademarks or registered trademarks of their respective companies.

Copyrights

Microsoft product screen shots used with permission from Microsoft.

Introduction

Thank you for purchasing the FH series 3D robot vision system.

This manual contains information that is necessary to use the FH series 3D robot vision system.

Please read this manual and make sure you understand the functionality and performance of the FH series 3D robot vision system before you attempt to use it in a control system.

Keep this manual in a safe place where it will be available for reference during operation.

Intended Audience

This manual is intended for the following personnel, who must also have knowledge of electrical systems (an electrical engineer or the equivalent).

- Personnel in charge of introducing FA systems.
- Personnel in charge of designing FA systems.
- Personnel in charge of installing and maintaining FA systems.
- Personnel in charge of managing FA systems and facilities.

Applicable Products

This manual covers the following products.

- FH-505□, FH-SMDA-GS050B

FH-505□-10, FH-505□-20, FH-555□, FH-555□-10, and FH-555□-20 are not applicable.

Part of the specifications and restrictions are given in other manuals. Refer to Relevant Manuals on *Related Manuals* on page 16.

Manual Structure

Page Structure

The following page structure is used in this manual.

The diagram illustrates the structure of a manual page, showing various elements and their corresponding annotations:

- Level 1 heading:** 4 Installation and Wiring
- Level 2 heading:** 4-3 Mounting Units
- Level 3 heading:** 4-3-1 Connecting Controller Components
- Text:** The Units that make up an NJ-series Controller can be connected simply by pressing the Units together and locking the sliders by moving them toward the back of the Units. The End Cover is connected in the same way to the Unit on the far right side of the Controller.
- Step 1:** 1 Join the Units so that the connectors fit exactly.
 - Diagram:** Shows units being joined with labels for Hook, Connector, and Hook holes.
- Step 2:** 2 The yellow sliders at the top and bottom of each Unit lock the Units together. Move the sliders toward the back of the Units as shown below until they click into place.
 - Diagram:** Shows sliders being moved with labels for Release, Lock, and Slider.
- Section Header:** **Precautions for Correct Use**
- Text:** The sliders on the tops and bottoms of the Power Supply Unit, CPU Unit, I/O Units, Special I/O Units, and CPU Bus Units must be completely locked (until they click into place) after connecting the adjacent Unit connectors.
- Page tab:** 4
- Manual name:** NJ-series CPU Unit Hardware User's Manual (W500)
- Page number:** 4-9

Annotations on the right side of the diagram:

- Level 1 heading:** 4 Installation and Wiring
- Level 2 heading:** 4-3 Mounting Units
- Level 3 heading:** 4-3-1 Connecting Controller Components
- Text:** Gives the current headings.
- Page tab:** 4
- Text:** Gives the number of the main section.

Annotations on the left side of the diagram:

- Level 2 heading:** 4-3 Mounting Units
- Level 3 heading:** 4-3-1 Connecting Controller Components
- A step in a procedure:** 1 Join the Units so that the connectors fit exactly. Indicates a procedure.
- Special information:** Icons indicate precautions, additional information, or reference information.
- Manual name:** NJ-series CPU Unit Hardware User's Manual (W500)

Note This illustration is provided only as a sample. It may not literally appear in this manual.

Special Information

Special information in this manual is classified as follows:



Precautions for Safe Use

Precautions on what to do and what not to do to ensure safe usage of the product.



Precautions for Correct Use

Precautions on what to do and what not to do to ensure proper operation and performance.



Additional Information

Additional information to read as required.

This information is provided to increase understanding or make operation easier.

Conventions Used in This Manual

Use of Quotation Marks and Brackets

In this manual, menus and other items are indicated as follows.

Bold	Menu	Indicates the menu bar, button, and icon.
<i>Italic</i>	Item name	Indicates the item and area names displayed on the screen.

Sections in This Manual

1	Input Image	1
2	Inspecting and Measuring	2
3	Compensate Image	3
4	Support Inspection and Measurement	4
5	Branch	5
6	Output Result	6
7	Display Result	7
I	Index	I

CONTENTS

Introduction	1
Intended Audience	1
Applicable Products	1
Manual Structure.....	2
Page Structure	2
Special Information	3
Conventions Used in This Manual	3
Sections in This Manual	5
Terms and Conditions Agreement.....	9
Warranty, Limitations of Liability	9
Application Considerations	10
Disclaimers	10
Safety Precautions.....	12
Precautions for Safe Use	13
Precautions for Correct Use	14
Regulations and Standards	15
Related Manuals.....	16
Revision History.....	18

Section 1 Input Image

1-1 FH series 3D robot vision system Processing items	1-2
1-1-1 Input image	1-2
1-2 Camera Image Input AOS.....	1-3
1-2-1 Settings Flow (Camera Image Input AOS).....	1-5
1-2-2 Camera setting(3D) (Camera Image Input AOS)	1-5
1-2-3 Camera setting(2D) (Camera Image Input AOS)	1-14
1-2-4 Output setting (Camera Image Input AOS)	1-16
1-2-5 Select camera (Camera Image Input AOS)	1-18
1-2-6 Key Points for Test Measurement and Adjustment (Camera Image Input AOS)	1-21
1-2-7 Measurement Results for Which Output is Possible (Camera Image Input AOS)	1-23
1-2-8 External Reference Tables (Camera Image Input AOS)	1-24

Section 2 Inspecting and Measuring

2-1 FH series 3D robot vision system Processing items	2-3
2-1-1 Measurement	2-3
2-2 3D Search	2-4
2-2-1 Settings Flow (3D Search)	2-5
2-2-2 Input parameters (3D Search).....	2-6
2-2-3 Model (3D Search).....	2-8
2-2-4 Region settings (3D Search).....	2-14
2-2-5 Measurement (3D Search).....	2-17

2-2-6	Judge cond. (3D Search)	2-30
2-2-7	Output Parameters (3D Search)	2-34
2-2-8	Key Points for Test Measurement and Adjustment (3D Search).....	2-34
2-2-9	Measurement Results for Which Output is Possible (3D Search).....	2-37
2-2-10	External Reference Tables (3D Search).....	2-38
2-3	Container Detection.....	2-44
2-3-1	Settings Flow (Container Detection)	2-46
2-3-2	Input parameters (Container Detection).....	2-47
2-3-3	Coordinate settings (Container Detection)	2-48
2-3-4	Floor settings (Container Detection)	2-52
2-3-5	Shape settings (Container Detection)	2-56
2-3-6	Region setting (Container Detection)	2-62
2-3-7	Measurement (Container Detection).....	2-63
2-3-8	Judge cond. (Container Detection)	2-67
2-3-9	Output Parameters (Container Detection).....	2-71
2-3-10	Key Points for Test Measurement and Adjustment (Container Detection).....	2-71
2-3-11	Measurement Results for Which Output Is Possible (Container Detection).....	2-74
2-3-12	External Reference Tables (Container Detection).....	2-75
2-4	Grasp Planning	2-83
2-4-1	Settings Flow (Grasp Planning)	2-84
2-4-2	Input parameters (Grasp Planning).....	2-84
2-4-3	Coordinate settings (Grasp Planning)	2-85
2-4-4	Pose of grasping (Grasp Planning)	2-88
2-4-5	Order of grasping (Grasp Planning).....	2-90
2-4-6	Collision detection (Grasp Planning).....	2-104
2-4-7	Judge cond. (Grasp Planning)	2-109
2-4-8	Output Parameters (Grasp Planning).....	2-115
2-4-9	Key Points for Test Measurement and Adjustment (Grasp Planning).....	2-116
2-4-10	Measurement Results for Which Output Is Possible (Grasp Planning).....	2-119
2-4-11	External Reference Tables (Grasp Planning).....	2-120

Section 3 Compensate Image

3-1	FH series 3D robot vision system Processing items	3-2
3-1-1	Compensate image	3-2

Section 4 Support Inspection and Measurement

4-1	FH series 3D robot vision system Processing items	4-2
4-1-1	Support measurement.....	4-2
4-2	3D Data Manager.....	4-3
4-2-1	CAD Data (3D Data Manager)	4-3
4-2-2	Hand Data (3D Data Manager)	4-6
4-2-3	Grasp DB (3D Data Manager).....	4-22
4-2-4	Key Points for Test Measurement and Adjustment (3D Data Manager)	4-36
4-2-5	Measurement Results for Which Output Is Possible (3D Data Manager)	4-38
4-2-6	External Reference Tables (3D Data Manager)	4-39
4-3	Camera Calibration AOS	4-40
4-3-1	Settings Flow (Camera Calibration AOS).....	4-41
4-3-2	Input parameter (Camera Calibration AOS).....	4-42
4-3-3	Geometric var. check (Camera Calibration AOS)	4-43
4-3-4	Calib. setting (Camera Calibration AOS)	4-46
4-3-5	Data in-out (Camera Calibration AOS).....	4-53
4-3-6	Key Points for Test Measurement and Adjustment (Camera Calibration AOS)	4-54
4-3-7	Measurement Results for Which Output Is Possible (Camera Calibration AOS).....	4-58
4-3-8	External Reference Tables (Camera Calibration AOS).....	4-59
4-4	HandEye Calibration.....	4-61
4-4-1	Settings Flow (HandEye Calibration)	4-62

4-4-2	Instruments settings (HandEye Calibration).....	4-63
4-4-3	Target settings (HandEye Calibration)	4-65
4-4-4	Sampling settings (HandEye Calibration)	4-67
4-4-5	Calibration result (HandEye Calibration).....	4-71
4-4-6	Key Points for Test Measurement and Adjustment (HandEye Calibration).....	4-73
4-4-7	Measurement Results for Which Output Is Possible (HandEye Calibration)	4-76
4-4-8	External Reference Tables (HandEye Calibration).....	4-77

Section 5 Branch

5-1	FH series 3D robot vision system Processing items	5-2
5-1-1	Branch.....	5-2

Section 6 Output Result

6-1	FH series 3D robot vision system Processing items	6-2
6-1-1	Output result.....	6-2

Section 7 Display Result

7-1	FH series 3D robot vision system Processing items	7-2
7-1-1	Display result.....	7-2

Index

Terms and Conditions Agreement

Warranty, Limitations of Liability

Warranties

- **Exclusive Warranty**

Omron's exclusive warranty is that the Products will be free from defects in materials and workmanship for a period of twelve months from the date of sale by Omron (or such other period expressed in writing by Omron). Omron disclaims all other warranties, express or implied.

- **Limitations**

OMRON MAKES NO WARRANTY OR REPRESENTATION, EXPRESS OR IMPLIED, ABOUT NON-INFRINGEMENT, MERCHANTABILITY OR FITNESS FOR A PARTICULAR PURPOSE OF THE PRODUCTS. BUYER ACKNOWLEDGES THAT IT ALONE HAS DETERMINED THAT THE PRODUCTS WILL SUITABLY MEET THE REQUIREMENTS OF THEIR INTENDED USE.

Omron further disclaims all warranties and responsibility of any type for claims or expenses based on infringement by the Products or otherwise of any intellectual property right.

- **Buyer Remedy**

Omron's sole obligation hereunder shall be, at Omron's election, to (i) replace (in the form originally shipped with Buyer responsible for labor charges for removal or replacement thereof) the non-complying Product, (ii) repair the non-complying Product, or (iii) repay or credit Buyer an amount equal to the purchase price of the non-complying Product; provided that in no event shall Omron be responsible for warranty, repair, indemnity or any other claims or expenses regarding the Products unless Omron's analysis confirms that the Products were properly handled, stored, installed and maintained and not subject to contamination, abuse, misuse or inappropriate modification. Return of any Products by Buyer must be approved in writing by Omron before shipment. Omron Companies shall not be liable for the suitability or unsuitability or the results from the use of Products in combination with any electrical or electronic components, circuits, system assemblies or any other materials or substances or environments. Any advice, recommendations or information given orally or in writing, are not to be construed as an amendment or addition to the above warranty.

See <http://www.omron.com/global/> or contact your Omron representative for published information.

Limitation on Liability; Etc

OMRON COMPANIES SHALL NOT BE LIABLE FOR SPECIAL, INDIRECT, INCIDENTAL, OR CONSEQUENTIAL DAMAGES, LOSS OF PROFITS OR PRODUCTION OR COMMERCIAL LOSS IN

ANY WAY CONNECTED WITH THE PRODUCTS, WHETHER SUCH CLAIM IS BASED IN CONTRACT, WARRANTY, NEGLIGENCE OR STRICT LIABILITY.

Further, in no event shall liability of Omron Companies exceed the individual price of the Product on which liability is asserted.

Application Considerations

Suitability of Use

Omron Companies shall not be responsible for conformity with any standards, codes or regulations which apply to the combination of the Product in the Buyer's application or use of the Product. At Buyer's request, Omron will provide applicable third party certification documents identifying ratings and limitations of use which apply to the Product. This information by itself is not sufficient for a complete determination of the suitability of the Product in combination with the end product, machine, system, or other application or use. Buyer shall be solely responsible for determining appropriateness of the particular Product with respect to Buyer's application, product or system. Buyer shall take application responsibility in all cases.

NEVER USE THE PRODUCT FOR AN APPLICATION INVOLVING SERIOUS RISK TO LIFE OR PROPERTY OR IN LARGE QUANTITIES WITHOUT ENSURING THAT THE SYSTEM AS A WHOLE HAS BEEN DESIGNED TO ADDRESS THE RISKS, AND THAT THE OMRON PRODUCT(S) IS PROPERLY RATED AND INSTALLED FOR THE INTENDED USE WITHIN THE OVERALL EQUIPMENT OR SYSTEM.

Programmable Products

Omron Companies shall not be responsible for the user's programming of a programmable Product, or any consequence thereof.

Disclaimers

Performance Data

Data presented in Omron Company websites, catalogs and other materials is provided as a guide for the user in determining suitability and does not constitute a warranty. It may represent the result of Omron's test conditions, and the user must correlate it to actual application requirements. Actual performance is subject to the Omron's Warranty and Limitations of Liability.

Change in Specifications

Product specifications and accessories may be changed at any time based on improvements and other reasons. It is our practice to change part numbers when published ratings or features are changed, or when significant construction changes are made. However, some specifications of the

Product may be changed without any notice. When in doubt, special part numbers may be assigned to fix or establish key specifications for your application. Please consult with your Omron's representative at any time to confirm actual specifications of purchased Product.

Errors and Omissions

Information presented by Omron Companies has been checked and is believed to be accurate; however, no responsibility is assumed for clerical, typographical or proofreading errors or omissions.

Safety Precautions

For details on Safety Precautions, refer to *Safety Precautions* in the *Vision System FH Series Hardware Setup Manual for 3D Robot Vision (Cat. No. Z436)*.

Precautions for Safe Use

For details on Precautions for Safe Use, refer to *Precautions for Safe Use* in the *Vision System FH Series Hardware Setup Manual for 3D Robot Vision (Cat. No. Z436)*.

Precautions for Correct Use

For details on Precautions for Correct Use, refer to *Precautions for Correct Use* in the *Vision System FH Series Hardware Setup Manual for 3D Robot Vision* (Cat. No. Z436).

Regulations and Standards

For details on Regulations and Standards, refer to *Regulations and Standards* in the *Vision System FH Series Hardware Setup Manual for 3D Robot Vision (Cat. No. Z436)*.

Related Manuals

The followings are the manuals related to this manual. Use these manuals for reference.

Name of Manual	Cat. No..	Model	Purpose	Contents
Vision System FH Instruction Sheet	3648743-1	FH-2□□2 FH-2□□2-□□ FH-5□□2 FH-5□□2-□□	To confirm the safety and usage precautions of the Vision System FH series Sensor Controller.	Describes the definitions of basic terms, meaning of signal words, and precautions for correct use of FH series in the manual.
Vision System FH Instruction Sheet	3102269-4	FH-2□□□ FH-2□□□-□□ FH-5□□□ FH-5□□□-□□	To confirm the safety and usage precautions of the Vision System FH series Sensor Controller.	Describes the definitions of basic terms, meaning of signal words, and precautions for correct use of FH series in the manual.
3D Vision Sensor FH-SMDA Instruction Sheet	3290410-0	FH-SMDA-GS050B	To confirm the safety and usage precautions of the 3D Vision Sensor FH-SMDA.	Describes the definitions of basic terms, the meaning of signal words, and precautions for correct use of 3D Vision Sensor FH-SMDA in the manual.
FH Application Software FH-UM3D1 Instruction Sheet	5665477-6	FH-UM3D1	To confirm the safety and usage precautions of the FH Application Software FH-UM3D1. When User want to know about the hardware specifications or to setup the FH Application Software FH-UM3D1.	Describes the definitions of basic terms, product specifications, how to use, meaning of signal words, and precautions for correct use of FH Application Software FH-UM3D1 in the manual.
Vision System FH series 3D Robot Vision Application Construction Guide	Z446	FH-505□ FH-SMDA-GS050B	When User want to know about the FH series 3D robot vision system.	Describes the soft functions, setup, and operations to use FH series 3D robot vision system.
Vision System FH series Hardware Setup Manual for 3D Robot Vision	Z436		When User want to know about the Hardware specifications or to setup the Sensor Controller of the FH series 3D robot vision system.	Describes FH series 3D robot vision system specifications, dimensions, part names, I/O information, installation information, and wiring information.
Vision System FH series Processing Item Function Reference Manual for 3D Robot Vision	Z445		When User confirm the details of each processing items at the create the measurement flow or operate it.	Describes the software functions, settings, and operations for using FH series 3D robot vision system.

Name of Manual	Cat. No..	Model	Purpose	Contents
Vision System FH/FHV Series User's Manual	Z365	FH-2□□□ FH-2□□□-□□ FH-5□□□	When User want to know about the FH/FHV series.	Describes the soft functions, setup, and operations to use FH/FHV series.
Vision System FH/FHV series Processing Item Function Reference Manual	Z341	FH-5□□□-□□ FH-L□□□ FH-L□□□-□□ FHV7□-□□□□□-□□□	When User confirm the details of each processing items at the create the measurement flow or operate it.	Describes the software functions, settings, and operations for using FH/FHV series.
Vision System FH/FHV Series User's manual for Commu- nications Settings	Z342		When User confirm the setting of communication functions.	Describes the functions, settings, and communications methods for communication between FH/FHV series and PLCs. The following communications protocol are described. Parallel, PLC Link, EtherNet/IP, EtherCAT, and Non-procedure.
Vision System FH series Macro Customize Func- tions Programming Manual	Z367	FH-2□□□ FH-2□□□-□□ FH-5□□□ FH-5□□□-□□ FH-L□□□ FH-L□□□-□□	When User operate or programming using Macro Customize functions.	Describes the functions, settings, and operations for using Macro Customize function of the FH series.

Revision History

A manual revision code appears as a suffix to the catalog number on the front and back covers of the manual.

Cat. No.	Z445-E1-03
-----------------	-------------------

↑
Revision code

Rev. Code	Rev. Date	Revision Contents
01	Feb. 2021	Original production
02	Dec. 2022	Revisions for update, <i>Related Manuals</i> . Additions for software version upgrade.
03	Jun. 2024	Revisions for update , <i>Related Manuals</i> . Additional support for FH-5051 and FH-5052.

1

Input Image

This chapter describes how to load images from cameras.

1-1	FH series 3D robot vision system Processing items	1-2
1-1-1	Input image	1-2
1-2	Camera Image Input AOS	1-3
1-2-1	Settings Flow (Camera Image Input AOS)	1-5
1-2-2	Camera setting(3D) (Camera Image Input AOS).....	1-5
1-2-3	Camera setting(2D) (Camera Image Input AOS).....	1-14
1-2-4	Output setting (Camera Image Input AOS).....	1-16
1-2-5	Select camera (Camera Image Input AOS).....	1-18
1-2-6	Key Points for Test Measurement and Adjustment (Camera Image Input AOS).....	1-21
1-2-7	Measurement Results for Which Output is Possible (Camera Image Input AOS).....	1-23
1-2-8	External Reference Tables (Camera Image Input AOS).....	1-24

1-1 FH series 3D robot vision system

Processing items

In FH series 3D robot vision system, the processing items that can be used with the FH series are different. The following shows the usability of processing items of FH series 3D robot vision system. Refer to the *Vision System FH/FHV Series Processing Item Function Reference Manual (Cat. No. Z341)*, for information on each processing item other than the FH series 3D robot vision system processing items.



Precautions for Correct Use

FH series 3D robot vision system cannot load data including processing items which it cannot be handled.

1-1-1 Input image

Processing item	Support	Processing item	Support
Camera Image Input AOS *1	OK	Photometric Stereo Image Input	-
Camera Image Input	-	Camera Switching	-
Camera Image Input FH	-	Measurement Image Switching	OK
Camera Image Input FHV	-	Multi-Trigger Imaging	-
Camera Image Input HDR	-	Multi-Trigger Imaging Task	-
Camera Image Input HDR Lite	-		

*1. This is a processing item specific to the FH series 3D robot vision system.

1-2 Camera Image Input AOS

This is a processing item specific to the FH series 3D robot vision system.

Set the conditions for loading images from the camera and for storing images of the measured objects. This processing item must be used when measuring.

In the camera image Input AOS (Active One Shot) processing item, 3D measurement is performed by one pattern projection imaging. The system captures images from a dedicated 3D vision sensor (FH-SMDA-GS050B) and outputs a depth map (i.e., an image that holds the 3D position [mm] in X, Y, and Z seen from the camera as pixel values) as a measurement image for use by other dedicated processing items for FH series 3D robot vision system. The 3D vision sensor emits a pattern light for 3D measurement in synchronization with the imaging trigger. The projected pattern image is then converted into a depth map in this processing item.

You can switch the lighting to 2D LED lighting to capture non-pattern images (normal grayscale images).

Used in the Following Case

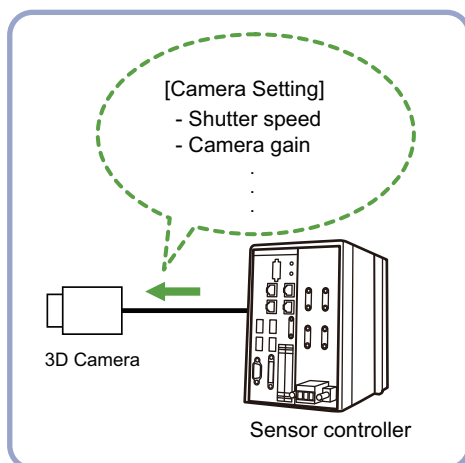



Precautions for Correct Use

- **Camera Image Input AOS** is preset for Unit 0. Do not set any processing item other than camera image input for Unit 0.
 - It cannot be used in *Double Speed Multi-input*, *Non-stop Adjustment Mode*, or *Multi-line Random Trigger Mode*.
 - If a camera is connected which is different from the one for the previous settings, the camera settings are returned to their initial settings.
 - Just after starting up the Sensor Controller or just after changing scenes, it becomes no image input.
 - If a logging image is re-measured with 3D vision sensor settings that differ from those used for logging, the results are not correct.
 - If the *Camera Configuration Tool*, etc. is used to set the **Camera No.** to a value other than 0, the system does not operate properly.
 - To capture 3D and 2D images continuously for image logging, you must set **Multiple image logging** to *ON* in **Tool – System setting – Other – Logging setting**.
 - If the shutter speed setting is different between the 3D and 2D images, there will be an overhead of about [3D shutter speed setting + 2D shutter speed setting + 90] ms compared with the same shutter speed setting. Even with the same shutter speed setting, there will be an overhead of about 10 ms if the gain setting is different.
-

1-2-1 Settings Flow (Camera Image Input AOS)

To set Camera Image Input AOS, follow the steps below.

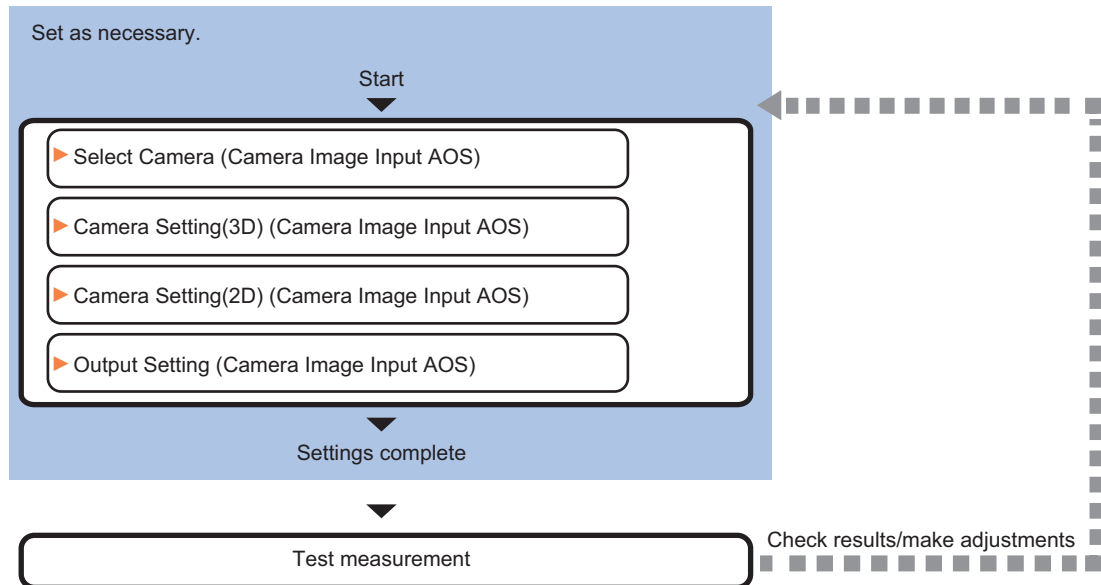

List of Camera Image Input AOS Inspection Items

Item	Description
Camera setting(3D)	Set the camera conditions for 3D imaging. <i>1-2-2 Camera setting(3D) (Camera Image Input AOS) on page 1-5</i>
Camera setting(2D)	Set the camera conditions for 2D imaging. <i>1-2-3 Camera setting(2D) (Camera Image Input AOS) on page 1-14</i>
Output setting	Set the measurement image to output. <i>1-2-4 Output setting (Camera Image Input AOS) on page 1-16</i>
Select camera	Select the camera to use for measurement. <i>1-2-5 Select camera (Camera Image Input AOS) on page 1-18</i>

1-2-2 Camera setting(3D) (Camera Image Input AOS)

Set the camera conditions for 3D imaging.

Set the following photographing conditions

- *View* on page 1-5
- *Camera settings* on page 1-6
- *Measurement settings* on page 1-7
- *Measurement results* on page 1-8
- *Display settings* on page 1-9



Precautions for Correct Use

Perform the setting with the following procedures according to the usage environment.

View

Switches the display in the Image display area.

- 1 In the Item tab area, click the **Camera setting(3D)** tab.
You can also set this from the **Camera setting(2D)** or **Output setting** tab.

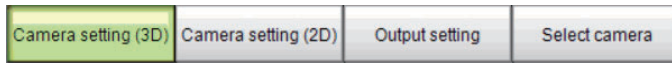

- 2 Click **Change display** to select the type of camera image.
The display in the Image display area will switch.



Setting item	Setting value [Factory default]	Description
Display	<ul style="list-style-type: none"> Through image [Freeze image] 	<ul style="list-style-type: none"> Through image: The latest image is always loaded from the camera and displayed. Freeze image: The image loaded in the immediately preceding measurement is displayed.

Camera settings

Adjust the settings related to camera shutter speed, camera gain, and light gain.
Adjust so that the light projection pattern can be seen on the workpiece as shown in the figure below.

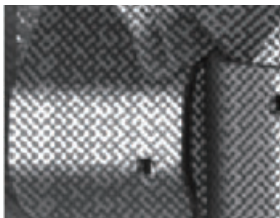

Set the shutter speed to adjust the exposure time.
Adjust the camera gain when images cannot be brightened through the shutter speed or lighting conditions. Usually, the factory default values can be used.
Example:

<u>Camera gain</u>		<u>Screen</u>	<u>Image</u>
208		Bad (noise increases)	Bright
0		Good (noise decreases)	Dark

Adjust the light gain when images must be brightened.

- 1 In the Item tab area, click the **Camera setting(3D)** tab.

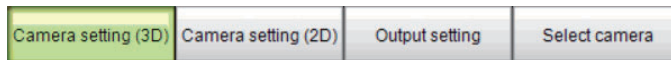

2 In the **Camera settings** area, place a check at the **3D imaging ON** option.

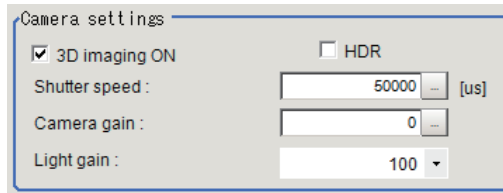

Setting item	Setting value [Factory default]	Description
3D imaging ON	<ul style="list-style-type: none"> [Checked] Unchecked 	Check this to capture 3D images.
HDR	<ul style="list-style-type: none"> Checked [Unchecked] 	<p>If Checked is selected, the 3D point cloud is restored from multiple images captured in different exposure time periods. The processing time increases because multiple images are captured.</p> <p>Use in the following cases:</p> <ul style="list-style-type: none"> When the light quantity in the center of the camera is strong, resulting in halation When materials such as resin and metal are mixed in the workpiece to be measured and 3D restoration cannot be performed for the entire workpiece at a single shutter speed When the luster of the workpiece itself is strong

3 Set the shutter speed, camera gain, and light gain while checking the image.

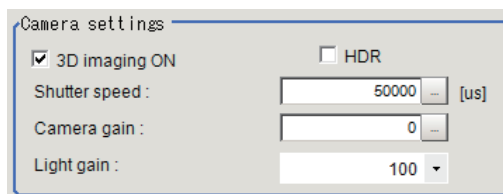

Setting item	Setting value [Factory default]	Description
Shutter speed	1,000 to 50,000 [μs] [50,000]	Set the shutter speed to adjust the exposure time.
Camera gain	0 to 208 [0]	Adjust the camera gain when images cannot be brightened through the shutter speed or lighting conditions. Usually, the factory default values can be used.
Light gain	25,30,35,40,45,50, 55,60,65,70,75,80, 85,90,95,100 [100]	Set the intensity of the light emitted for imaging.

Measurement settings

Make the settings related to measurement.

- 1 In the Item tab area, click the **Camera setting(3D)** tab.

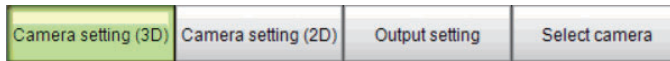

- 2 Set the value in the **Measurement settings** area.

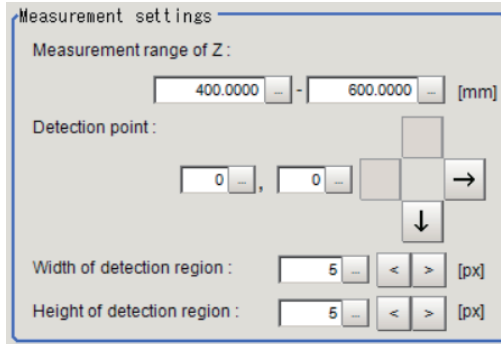

Setting item	Setting value [Factory default]	Description
Measurement range of Z	200.0000 to 2,000.0000 [mm] [400.0000] to [600.0000]	Set the upper and lower limits of the measurement range [mm] in which to restore 3D point clouds.
Detection point	0 to 9,999 [0], [0]	Set the detection point for which to check the measurement results. You can also set this by directly clicking the measurement image.
Width of detection region	1 to 9,999 [px] [5]	Set the width of the region for which to calculate the measurement results.
Height of detection region	1 to 9,999 [px] [5]	Set the height of the region for which to calculate the measurement results.

Measurement results

You can check the measurement results.

- 1 In the Item tab area, click the **Camera setting(3D)** tab.

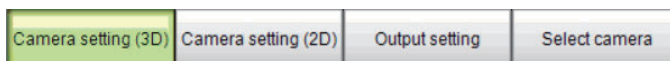

- 2 The measurement results are displayed in the **Measurement results** area.

Measurement results	
Measurement value X :	0.0000 [mm]
Measurement value Y :	0.0000 [mm]
Measurement value Z :	0.0000 [mm]
Maximum value of Z :	0.0000 [mm]
Minimum value of Z :	0.0000 [mm]
Average value of Z :	0.0000 [mm]

Item	Description
Measurement value X	The X value [mm] of the detection point is displayed.
Measurement value Y	The Y value [mm] of the detection point is displayed.
Measurement value Z	The Z value [mm] of the detection point is displayed.
Maximum value of Z	The maximum Z value [mm] of the measurement range is displayed.
Minimum value of Z	The minimum Z value [mm] of the measurement range is displayed.
Average value of Z	The average Z value [mm] of the measurement range is displayed.

Display settings

You can change the display settings.

- 1 In the Item tab area, click the **Camera setting(3D)** tab.

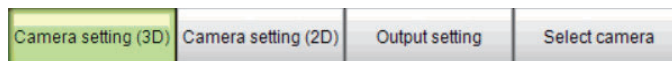

- 2 In the **Display settings** area, set the image to display.
The settings are applied to the display image from the processing item.

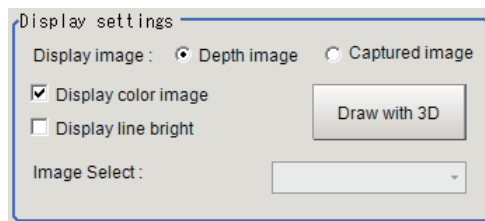

Setting item	Setting value [Factory default]	Description
Display image	<ul style="list-style-type: none"> • [Distance image] • Captured image 	Select the image type of the display image. <ul style="list-style-type: none"> • Distance image: A monochrome or color image converted from the distance (the Z value in the depth map) is displayed. • Captured image: A pattern-light projected image is displayed.

Setting item	Setting value [Factory default]	Description
Display color image	<ul style="list-style-type: none"> [Checked] Unchecked 	<p>This setting item is enabled only when Display image is set to <i>Distance image</i>.</p> <ul style="list-style-type: none"> Checked: The distance image is displayed as a color image. It is displayed in red (near) to blue (far). Also, the places where measurement is not possible are displayed in black. Unchecked: The distance image is displayed as a monochrome image. It is displayed in white (near) to black (far). Also, the places where measurement is not possible are displayed in black.
Display line bright	<ul style="list-style-type: none"> Checked [Unchecked] 	<ul style="list-style-type: none"> Checked: Display line bright is enabled. <i>Line Bright</i> on page 1-12 Unchecked: Display line bright is disabled.
Image Select	<ul style="list-style-type: none"> [HDR] Input Image1 Input Image2 	<p>Enabled only when HDR is checked in the camera condition settings.</p> <p>Select the image to display from HDR and captured image. When Display image is <i>Captured image (3D)</i>, <i>HDR</i> image cannot be selected.</p>
Draw with 3D	-	<p>Click this to start the 3D result display tool FZ-3DVisualizer. The 3D result display tool FZ-3DVisualizer displays measurement point clouds in 3D.</p> <p>Refer to <i>Checking 3D Measurement Results (FZ-3DVisualizer)</i> on page 1-13.</p>

- Distance image displayed as a color image

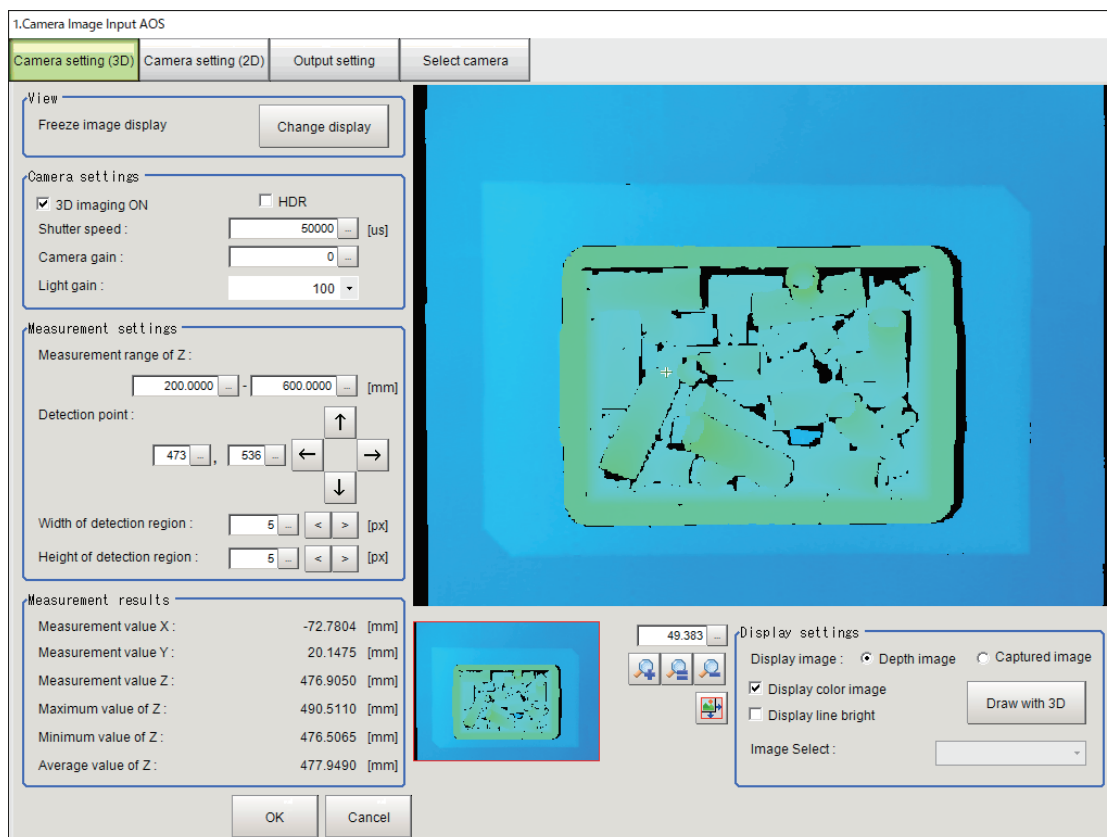

- Distance image displayed as a monochrome image

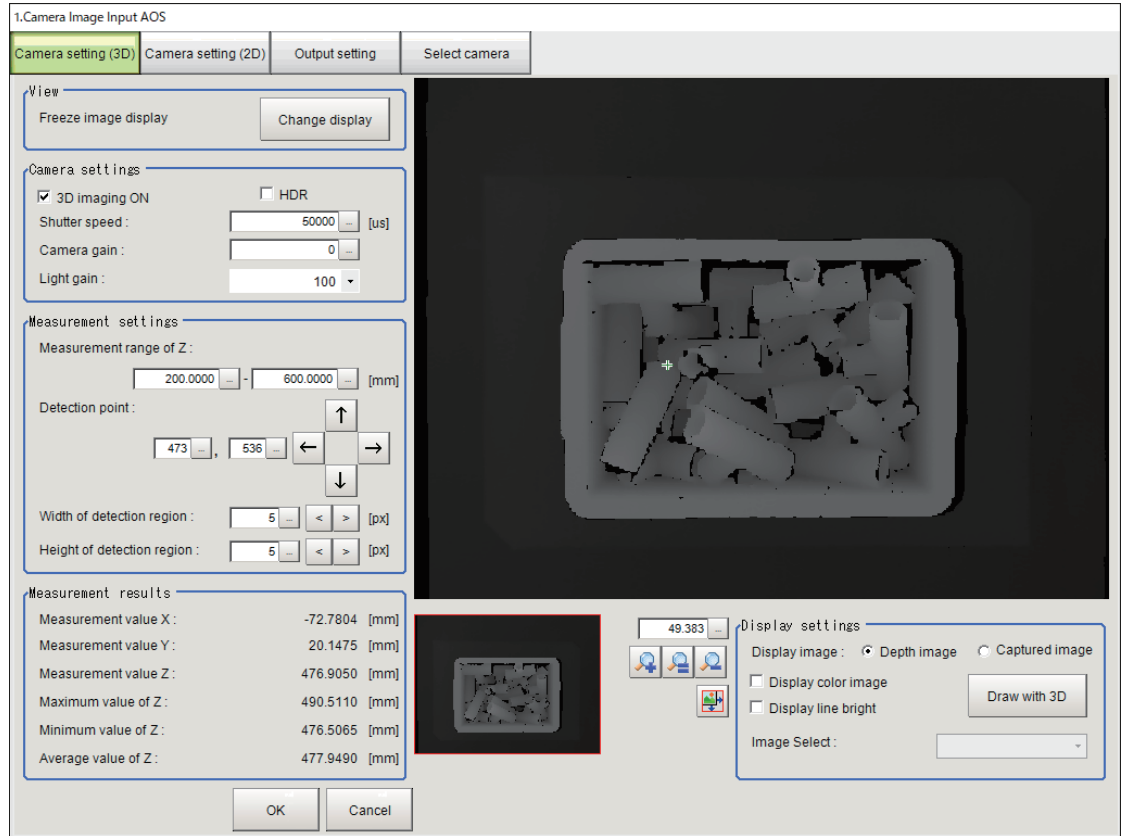

Display line bright

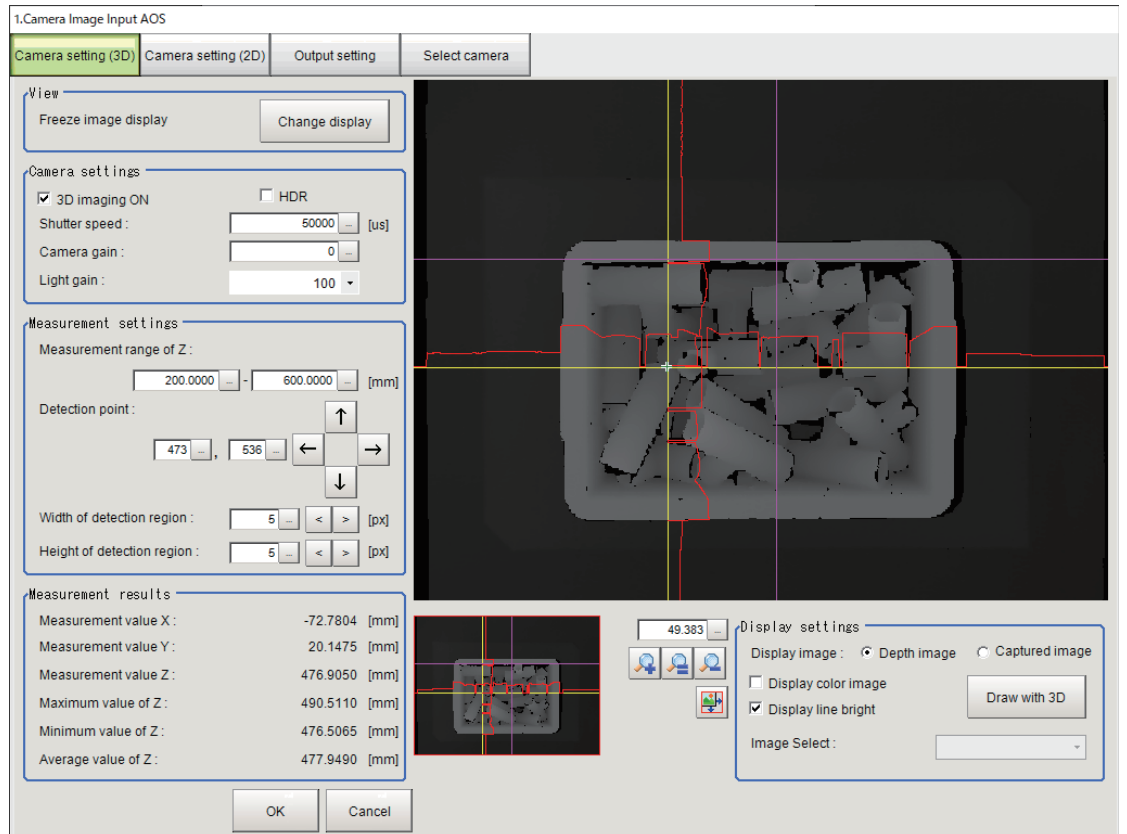

- Captured image

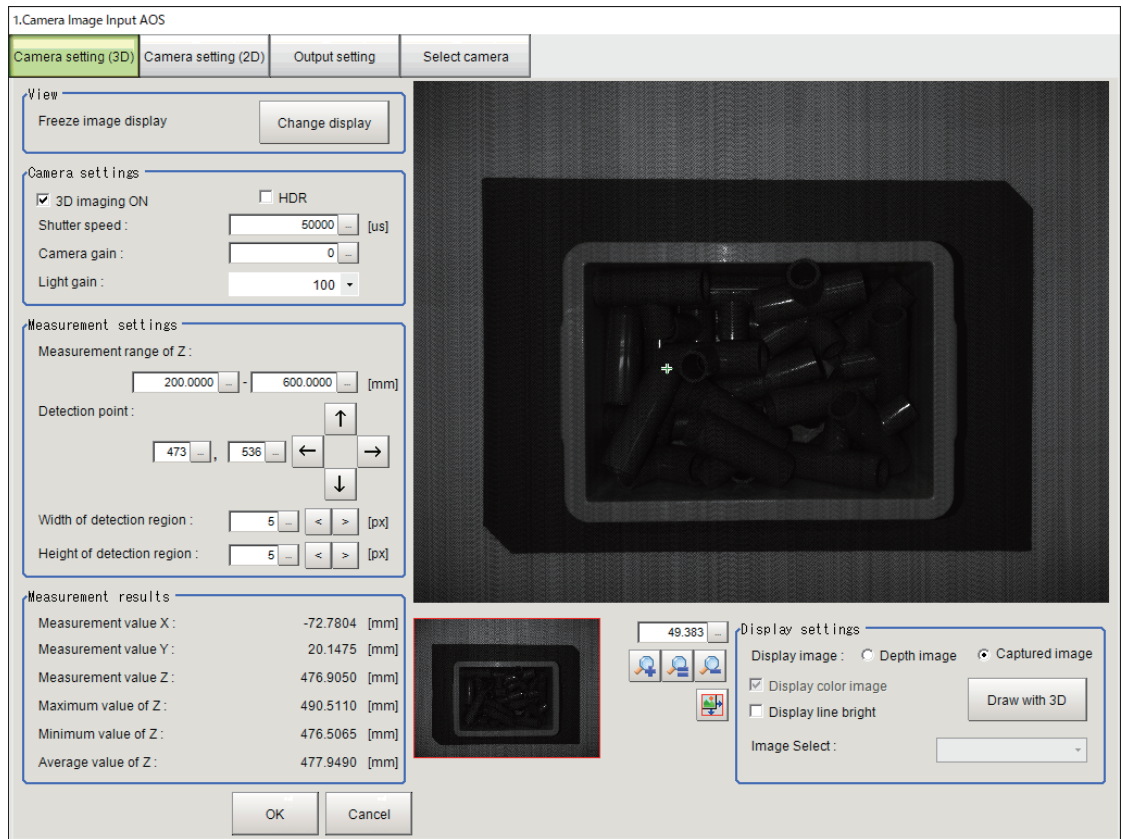

● Line Bright

A graph showing gray distribution for one line in the image is called the *Line bright*. Each line bright corresponding to R, G, B for any line in horizontal and vertical directions is displayed.

- 1 In the **Display settings** area, place a check at the **Display line bright** option.

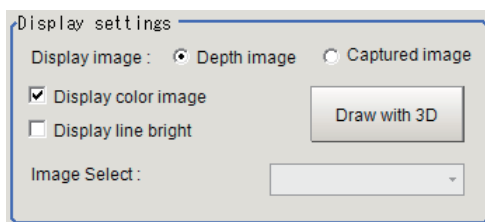

- 2 Move the line to a position whose density distribution is desired to see.

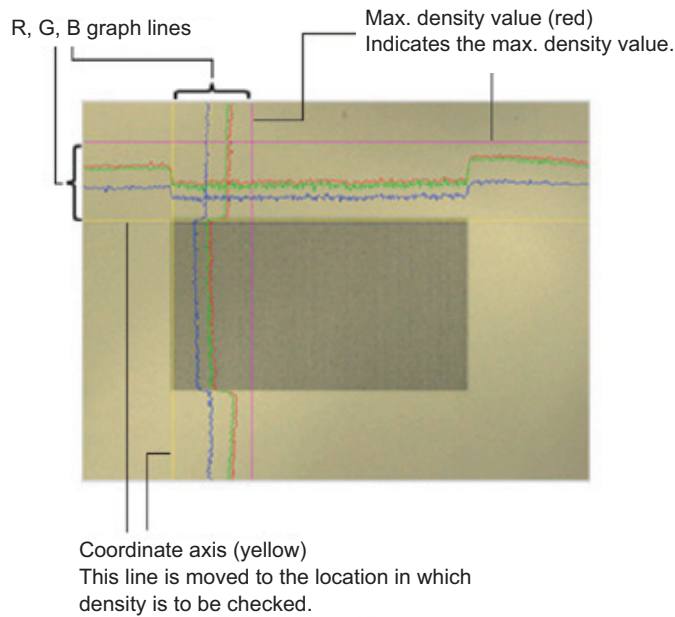

● Checking 3D Measurement Results (FZ-3DVisualizer)

FZ-3DVisualizer is a result display tool that draws 3D point clouds, recognized workpieces, recognized pose of grasping, etc. in 3D space. Use this tool to check the detection results for the **3D Search** and **Grasp Planning** processing items to see if objects are detected in appropriate positions in 3D space.

FZ-3DVisualizer

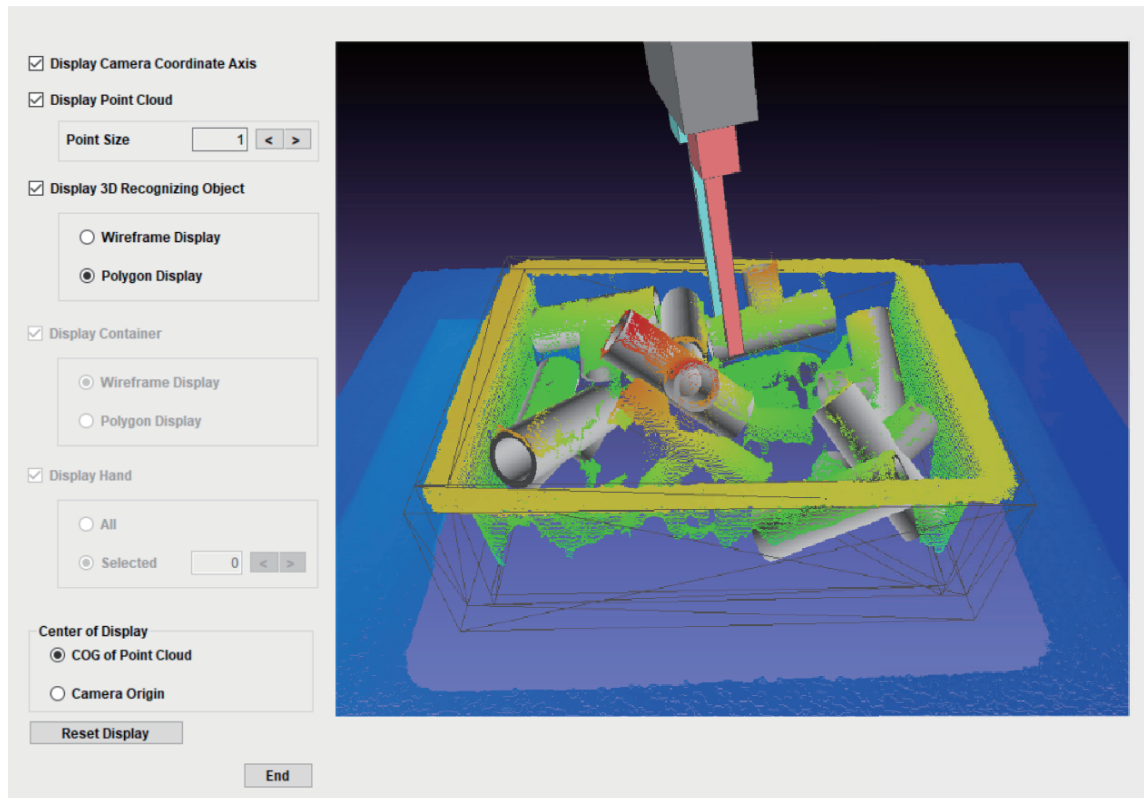

3D objects are displayed in the image display area.

Operation	Description
Left-click + Drag	You can move the viewpoint by rotating the image around the display center of the image display area.
Mouse wheel scroll	You can zoom in and out the image around the display center of the image display area.
Middle click + Drag or Shift key + Left-click + Drag	You can move the display center of the image display area.

Item	Description
Display Camera Coordinate Axis	Show or hide the camera coordinate axes.
Display Point Cloud	Show or hide the point cloud data.
Point Size	Change the size of the displayed point cloud. The point cloud size range is 1 to 5.
Display 3D Recognizing Object	Show or hide the workpiece recognized in the 3D Search processing item.
Wireframe Display	Set the workpiece display format to wireframe display.
Polygon Display	Set the workpiece display format to polygon display.
Display Container	Show or hide the container detected in the Container Detection processing item. It cannot be set in the 3D Search processing item.
Wireframe Display	Set the workpiece display format to wireframe display.
Polygon Display	Set the workpiece display format to polygon display.
Display Hand	Show or hide the pose of grasping calculated in the Grasp Planning processing item. It cannot be set in the 3D Search processing item.
All	All candidates are displayed at the same time.
Selected	One of the candidates for the specified measurement result number is displayed.
Center of Display	Switch the display center of the image display area between the center of gravity of the point cloud (center of gravity XYZ of the point cloud data) and the camera origin.
COG of Point Cloud	
Camera Origin	
Reset Display	Reset the display position of the image display area to the initial position.
End	Close the FZ-3DVisualizer tool.

1-2-3 Camera setting(2D) (Camera Image Input AOS)

Set the camera conditions for 2D imaging.

The 2D imaging is used when the contour features are acquired from the 2D captured image in the **3D Search** processing item, or when the container is detected in the **Container Detection** processing item.

Set the following photographing conditions

- *View* on page 1-15
- *Camera settings* on page 1-15



Precautions for Correct Use

Perform the setting with the following procedures according to the usage environment.

View

Switches the display in the Image display area.

- 1 In the Item tab area, click the **Camera setting(2D)** tab.
You can also set this from the **Camera setting(3D)** or **Output setting** tab.

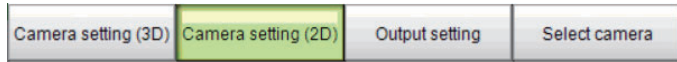

- 2 Click **Change display** to select the type of camera image.
The display in the Image display area will switch.



Setting item	Setting value [Factory default]	Description
Display	<ul style="list-style-type: none"> Through image [Freeze image] 	<ul style="list-style-type: none"> Through image: The latest image is always loaded from the camera and displayed. Freeze image: The image loaded in the immediately preceding measurement is displayed.

Camera settings

Adjust the settings related to camera shutter speed, camera gain, and light gain.

Set the shutter speed to adjust the exposure time.

Adjust the camera gain when images cannot be brightened through the shutter speed or lighting conditions. Usually, the factory default values can be used.

Example:

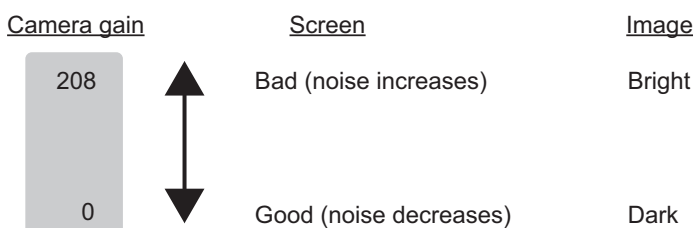

Adjust the light gain when images must be brightened.

- 1 In the Item tab area, click the **Camera setting(2D)** tab.

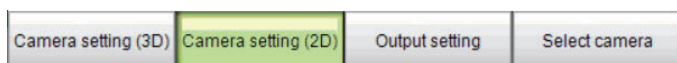

- 2 In the **Camera settings** area, place a check at the **2D imaging ON** option.

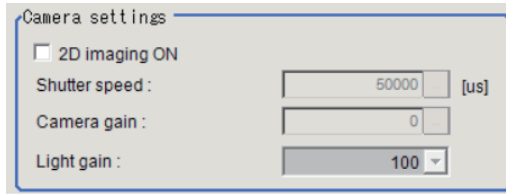

Setting item	Setting value [Factory default]	Description
2D imaging ON	<ul style="list-style-type: none"> • Checked • [Unchecked] 	Check this to capture 2D images.

3 Set the shutter speed, camera gain, and light gain while checking the image.

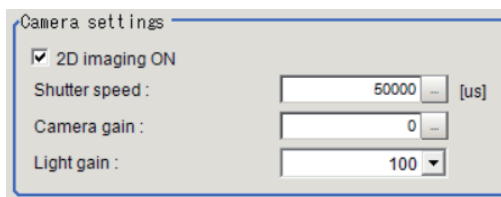

Setting item	Setting value [Factory default]	Description
Shutter speed	1,000 to 50,000 [μs] [50,000]	Set the shutter speed to adjust the exposure time.
Camera gain	0 to 208 [0]	Adjust the camera gain when images cannot be brightened through the shutter speed or lighting conditions. Usually, the factory default values can be used.
Light gain	25,30,35,40,45,50, 55,60,65,70,75,80, 85,90,95,100 [100]	Set the intensity of the light emitted for imaging.

1-2-4 Output setting (Camera Image Input AOS)

Set the measurement image to output.

View

Switches the display in the Image display area.

1 In the Item tab area, click the **Output setting** tab.
You can also set this from the **Camera setting(3D)** or **Camera setting(2D)** tab.

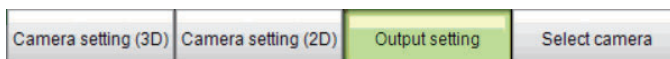

2 Click **Change display** to select the type of camera image.
The display in the Image display area will switch.

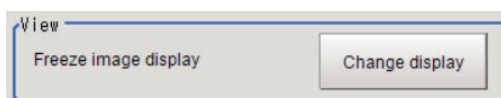

Setting item	Setting value [Factory default]	Description
Display	<ul style="list-style-type: none"> Through image [Freeze image] 	<ul style="list-style-type: none"> Through image: The latest image is always loaded from the camera and displayed. Freeze image: The image loaded in the immediately preceding measurement is displayed.

Depth image setting

Set the depth image.

- 1 In the Item tab area, click the **Output setting** tab.
- 2 Set the value in the **Depth image setting** area.

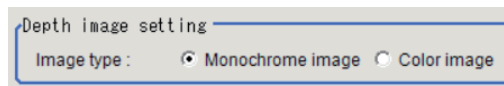

Setting item	Setting value [Factory default]	Description
Image type	<ul style="list-style-type: none"> [Monochrome image] Color image 	Set the image type when Measurement image 0 is set to <i>Depth image</i> .

Measurement image settings

Set the measurement image.

- 1 In the Item tab area, click the **Output setting** tab.
- 2 In the **Measurement image settings** area, the current measurement image settings are displayed.

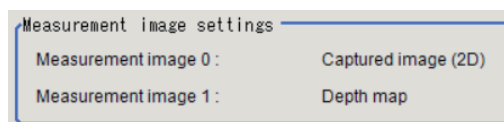

Setting item	Setting value [Factory default]	Description
Measurement image 0	<ul style="list-style-type: none"> [Depth image] Captured image (2D) 	This item is set to <i>Captured image (2D)</i> when 2D imaging ON is checked in Camera setting(2D) .
Measurement image 1	Depth map	Depth map: An image that holds the 3D position [mm] in X, Y, and Z seen from the camera as pixel values

1-2-5 Select camera (Camera Image Input AOS)

Select the camera to use for measurement.

Select setting

Set the camera number to use for measurement.

- 1 In the Item Tab area, click **Select camera**.

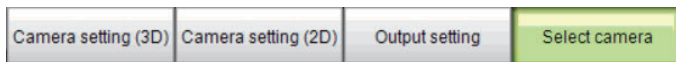

- 2 The **Camera No.** in the **Select setting** is fixed to *Camera 0*. There is no need to set this.



Camera Information

Check information on the connected 3D vision sensor. To re-measure a logging image, load information on the camera used during logging.

- 1 In the Item Tab area, click **Select camera**.

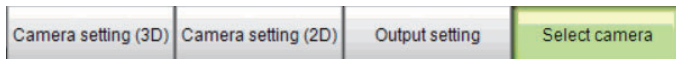

- 2 In the **Camera Information** area, you can check information on the currently connected camera.

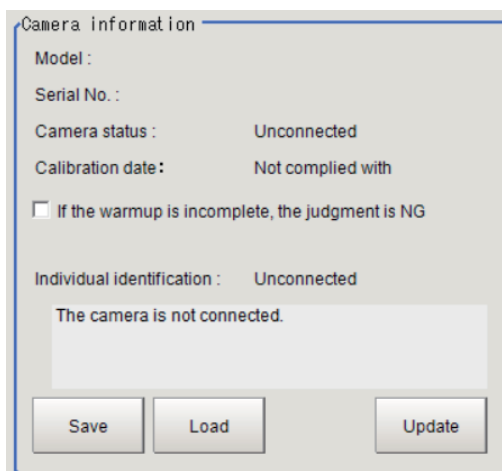

Setting item	Setting value [Factory default]	Description
Model	-	The model of the connected camera is displayed. If the camera is not connected, this item is left blank.
Serial No.	-	The serial number of the connected camera is displayed. If the camera is not connected, this item is left blank.
Camera status	<ul style="list-style-type: none"> • 1: OK • -1: Warmup • -2: Overheat • -3: Error (system error 1, I2C communication error) • -4: Error (system error 2, heater connection error) • -5: Error (system error 3, heater temperature error) • -6: Error (system error 4, board temperature error) • -7: Error (system error 5, power supply error) • -8: Error (Ethernet comm. error) • -10: Unconnected 	<p>The warmup status of the connected camera is displayed.</p> <p>To ensure stable measurement with the camera, the optical components are controlled to a constant temperature. Therefore, the system performs a few minutes of warmup after the power is turned ON. The warmup time varies depending on the ambient temperature and other conditions.</p> <p>The status is <i>OK</i> if the warmup is completed and <i>Unconnected</i> if the camera is not connected.</p> <p>It is updated when you click Load or Update, or switch the Item tab.</p>
Calibration date	-	The date and time at which the camera was calibrated in the Camera Calibration AOS processing item is displayed. (Example: 2021/2/1 10:34:56) If it is not calibrated, <i>Not complied</i> is displayed.
If the warmup is incomplete, the judgement is NG	<ul style="list-style-type: none"> • Checked • [Unchecked] 	If checked, the judgment result for this processing item is NG if the warmup of the connected camera is incomplete.
Individual identification	<ul style="list-style-type: none"> • 1: OK • -1: Error (unregistered model) • -2: Error (unmatched model) • -10: Unconnected • -11: Error (incorrect model) 	<p>The individual identification status of the connected camera is displayed.</p> <p>The status is <i>OK</i> if the individual identification of the camera is completed and <i>Unconnected</i> if the camera is not connected.</p>

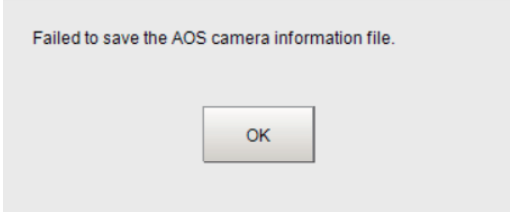
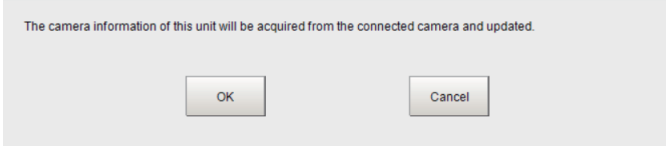
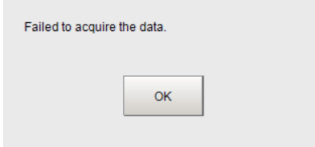
Setting item	Setting value [Factory default]	Description
Save	-	<p>Click this to start FileExplorer, with which you can save the calibration data for the connected camera to a file.</p> <p>If the camera is not connected and the calibration data for the camera is not loaded, an error dialog will be displayed when you save in the FileExplorer.</p> <p>Error</p> 
Load	-	<p>Click this to start FileExplorer, with which you can load the calibration data for the camera from a file.</p>
Update	-	<p>Click this to display the following confirmation dialog. Select OK to reacquire the camera information.</p> <p>Confirm</p>  <p>If the camera is not connected, an error dialog will be displayed when you select OK in the confirmation dialog.</p> <p>Error</p> 

Calibration parameter setting

- 1 In the Item Tab area, click **Select camera**.

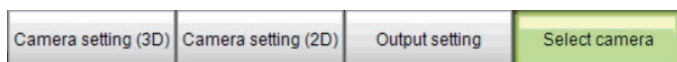

- 2 In the **Calibration parameter setting** area, set whether to get calibration parameters from the sensor during measurement.

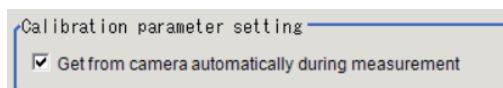

Setting item	Setting value [Factory default]	Description
Get from camera automatically during measurement	<ul style="list-style-type: none"> [Checked] Unchecked 	<ul style="list-style-type: none"> Checked: The system automatically gets calibration parameters from the connected 3D vision sensor during measurement. It does not get calibration parameters during re-measurement of a logging image. It takes 10 ms to get calibration parameters from the 3D vision sensor. Unchecked: The system uses the calibration parameters held in the processing item to perform measurement.

1-2-6 Key Points for Test Measurement and Adjustment (Camera Image Input AOS)

The following content is displayed in the *Detail result* area as text.



Precautions for Correct Use

Executing test measurements will also update the measurement results and the figures in the image.

Displayed item	Description
Judge	Judgment result 0: No judgment (unmeasured) 1: Judgment result OK -1: Judgment result NG -10: Error (image format mismatch) -11: Error (unregistered model) -12: Error (insufficient memory) -20: Error (other errors)
Camera status	1: OK -1: Warmup -2: Overheat -3: Error (system error 1, I2C communication error) -4: Error (system error 2, heater connection error) -5: Error (system error 3, heater temperature error) -6: Error (system error 4, board temperature error) -7: Error (system error 5, power supply error) -8: Error (Ethernet comm. error) -10: Unconnected
Individual identification	1: OK -1: Error (unregistered model) -2: Error (unmatched model) -10: Unconnected -11: Error (incorrect model)
Camera No.	The camera number to use for measurement
Measurement value X	The X value [mm] of the detection point
Measurement value Y	The Y value [mm] of the detection point
Measurement value Z	The Z value [mm] of the detection point
Average value of Z	The average Z value [mm] of the measurement range
Maximum value of Z	The maximum Z value [mm] of the measurement range
Minimum value of Z	The minimum Z value [mm] of the measurement range

The image specified in the Sub-image number in the image display setting is displayed in the *Image Display* area.

Sub-image number	Description of image to be displayed
0	The measure image is displayed.
1	The depth image is displayed
2	The captured (2D) image is displayed.
3	The captured (3D) image is displayed.

Key Points for Adjustment (Camera Image Input AOS)

Adjust the setting parameters referring to the following points.

● When the distance image is displayed in black, or partially in black

Parameter to be adjusted	Remedy
Camera setting(3D) - 3D imaging ON	Check 3D imaging ON in Camera setting(3D) , if it is not checked.
Camera setting(3D) - Measurement range of Z	The measurement object may not exist in the Measurement range of Z setting in Camera setting(3D) . Set the measurement range of Z wider, or move the measurement object into the setting range.
Camera setting(3D) - Shutter speed Camera gain Light gain	The pattern image may not be captured. Adjust the Shutter speed , Camera gain , and Light gain in Camera setting(3D) so that the projected pattern is clearly visible on the workpiece.
- (Calibration data of the 3D vision sensor)	The 3D vision sensor may not be calibrated accurately. Check the calibration status.
Select camera	The calibration data loaded in the processing item may not match the calibration data for the connected 3D vision sensor. Click Select camera , and then click the Load button to load the information on the currently connected 3D vision sensor.

● When judgment is NG although 3D measurement is successful

Parameter to be adjusted	Remedy
Select camera	The warmup of the 3D vision sensor may not be complete. Uncheck the If the warmup is incomplete, the judgement is NG box and wait until the warmup is completed.

● When a logging image does not produce the intended output

Parameter to be adjusted	Remedy
Camera setting(3D) Camera setting(2D)	The current settings may be different from the settings used when the logging image was captured. Change the settings back to the settings used when the logging image was captured.

- When judgment is NG with no image input

Parameter to be adjusted	Remedy
-	<p>If the Camera status is <i>Overheat</i>, the 3D vision sensor is warmed up beyond the set point. Adjust the trigger interval so that it is not shorter than 1 s.</p> <p>If the Camera status is <i>system error 1</i>, <i>system error 2</i>, <i>system error 3</i>, <i>system error 4</i>, or <i>system error 5</i>, and the ERR indicator on the 3D vision sensor is lit, a system error occurred in the 3D vision sensor. In this case, request for a repair.</p> <p>If the Camera status is <i>Ethernet comm. error</i>, the cable may be broken. Replace the LAN cable of the 3D vision sensor with a non-defective one, and restart both the FH series Sensor Controller and the 3D vision sensor.</p>

- When the update of the image on the setting screen or the update interval of the image in Through display is slow

Parameter to be adjusted	Remedy
-	If the Camera status is <i>Overheat</i> , the 3D vision sensor is warmed up beyond the set point. Stop updating or capturing the image for a while to allow the camera to recover from the excessively warmed up state.

1-2-7 Measurement Results for Which Output is Possible (Camera Image Input AOS)

The following values can be output using processing items related to result output. It is also possible to reference measurement values from calculation expressions and other processing units.

Measurement items	Character string	Description
Judge	JG	Judgment result 0: No judgment (unmeasured) 1: Judgment result OK -1: Judgment result NG -10: Error (image format mismatch) -11: Error (unregistered model) -12: Error (insufficient memory) -20: Error (other errors)
Measurement value X	X	The X value [mm] of the detection point
Measurement value Y	Y	The Y value [mm] of the detection point
Measurement value Z	Z	The Z value [mm] of the detection point
Average value of Z	AVZ	The average Z value [mm] of the measurement range
Maximum value of Z	MXZ	The maximum Z value [mm] of the measurement range
Minimum value of Z	MNZ	The minimum Z value [mm] of the measurement range

Measurement items	Character string	Description
Camera status	CS	1: OK -1: Warmup -2: Overheat -3: Error (system error 1, I2C communication error) -4: Error (system error 2, heater connection error) -5: Error (system error 3, heater temperature error) -6: Error (system error 4, board temperature error) -7: Error (system error 5, power supply error) -8: Error (Ethernet comm. error) -10: Unconnected
Individual identification	MS	1: OK -1: Error (unregistered model) -2: Error (unmatched model) -10: Unconnected -11: Error (incorrect model)

1-2-8 External Reference Tables (Camera Image Input AOS)

No.	Data name	Data ident	Set/Get	Data range
0	Judgement	judge	Get only	0: No judgment (unmeasured), 1: Judgment result OK, -1: Judgment result NG, -10: Error (image format mismatch), -11: Error (unregistered model), -12: Error (insufficient memory), -20: Error (other errors)
5	Measurement value X	measValueX	Get only	-99,999.9999 to 99,999.9999
6	Measurement value Y	measValueY	Get only	-99,999.9999 to 99,999.9999
7	Measurement value Z	measValueZ	Get only	-99,999.9999 to 99,999.9999
8	Average value of Z	measValueAveZ	Get only	-99,999.9999 to 99,999.9999
9	Maximum value of Z	measValueMaxZ	Get only	-99,999.9999 to 99,999.9999
10	Minimum value of Z	measValueMinZ	Get only	-99,999.9999 to 99,999.9999
11	Status of Camera	cameraStatus	Get only	1: OK, -1: Warmup, -2: Overheat, -3: Error (system error 1), -4: Error (system error 2), -5: Error (system error 3), -6: Error (system error 4), -7: Error (system error 5), -8: Error (ethernet comm. error), -10: Unconnected
12	Individual identification of camera	modelStatus	Get only	1: OK, -1: Error (unregistered model), -2: Error (unmatched model), -10: Unconnected, -11: Error (incorrect model)
120	Reflection flag of warmup state in judgement	warmupJudgeFlg	Set/Get	0: OFF, 1: ON

No.	Data name	Data ident	Set/Get	Data range
121	2D imaging ON flag	inputImage2dFlg	Set/Get	0: OFF, 1: ON
122	Distance image	depthImageKind	Set/Get	0: Monochrome image, 1: Color image
123	3D imaging ON flag	inputImage3dFlg	Set/Get	0: OFF, 1: ON
150	Upper limit of measurement range of Z	maxZ	Set/Get	200.0000 to 2,000.0000
151	Lower limit of measurement range of Z	minZ	Set/Get	200.0000 to 2,000.0000
160	Detection point X	measPointX	Set/Get	0 to 9,999
161	Detection point Y	measPointY	Set/Get	0 to 9,999
162	Width of detection region	measWidth	Set/Get	1 to 9,999
163	Height of detection region	measHeight	Set/Get	1 to 9,999
200	Shutter speed (3D)	exposureTime3d	Set/Get	1,000 to 50,000
201	Camera gain (3D)	gain3d	Set/Get	0 to 208
202	Light gain (3D)	lightGain3d	Set/Get	0: 25, 1: 30, 2: 35, 3: 40, 4: 45, 5: 50, 6: 55, 7: 60, 8: 65, 9: 70, 10: 75, 11: 80, 12: 85, 13: 90, 14: 95, 15: 100
205	HDR ON flag (3D)	hdr3dFlg	Set/Get	0: OFF, 1: ON
206	HDR input number (3D)	hdrImageNum3d	Set/Get	2 to 4
207	HDR exposure rate (3D)	hdrExposureRate3d	Set/Get	0.000 to 100.000
300	Shutter speed (2D)	exposureTime2d	Set/Get	1,000 to 50,000
301	Camera gain (2D)	gain2d	Set/Get	0 to 208
302	Light gain (2D)	lightGain2d	Set/Get	0: 25, 1: 30, 2: 35, 3: 40, 4: 45, 5: 50, 6: 55, 7: 60, 8: 65, 9: 70, 10: 75, 11: 80, 12: 85, 13: 90, 14: 95, 15: 100
430	Automatic get flag of calibration parameters	autoUpdateCalibDataFlg	Set/Get	0: OFF, 1: ON
5001	Current status of camera	cameraStatusCurrent	Get only	1: OK, -1: Warmup, -2: Overheat, -3: Error (system error 1), -4: Error (system error 2), -5: Error (system error 3), -6: Error (system error 4), -7: Error (system error 5), -8: Error (ethernet comm. error), -10: Unconnected
5002	Current individual identification of camera	modelStatusCurrent	Get only	1: OK, -1: Error (unregistered model), -2: Error (unmatched model), -10: Unconnected, -11: Error (incorrect model)

2

Inspecting and Measuring

This chapter describes how to set up the processing items that execute measurement. In addition, key points for adjustment addressing unstable measurement results and shortening measurement time will also be introduced.

2-1	FH series 3D robot vision system Processing items.....	2-3
2-1-1	Measurement.....	2-3
2-2	3D Search.....	2-4
2-2-1	Settings Flow (3D Search).....	2-5
2-2-2	Input parameters (3D Search).....	2-6
2-2-3	Model (3D Search).....	2-8
2-2-4	Region settings (3D Search).....	2-14
2-2-5	Measurement (3D Search).....	2-17
2-2-6	Judge cond. (3D Search).....	2-30
2-2-7	Output Parameters (3D Search).....	2-34
2-2-8	Key Points for Test Measurement and Adjustment (3D Search).....	2-34
2-2-9	Measurement Results for Which Output is Possible (3D Search).....	2-37
2-2-10	External Reference Tables (3D Search).....	2-38
2-3	Container Detection.....	2-44
2-3-1	Settings Flow (Container Detection).....	2-46
2-3-2	Input parameters (Container Detection).....	2-47
2-3-3	Coordinate settings (Container Detection).....	2-48
2-3-4	Floor settings (Container Detection).....	2-52
2-3-5	Shape settings (Container Detection).....	2-56
2-3-6	Region setting (Container Detection).....	2-62
2-3-7	Measurement (Container Detection).....	2-63
2-3-8	Judge cond. (Container Detection).....	2-67
2-3-9	Output Parameters (Container Detection).....	2-71
2-3-10	Key Points for Test Measurement and Adjustment (Container Detection)....	2-71
2-3-11	Measurement Results for Which Output Is Possible (Container Detection) .	2-74
2-3-12	External Reference Tables (Container Detection).....	2-75
2-4	Grasp Planning.....	2-83
2-4-1	Settings Flow (Grasp Planning).....	2-84
2-4-2	Input parameters (Grasp Planning).....	2-84
2-4-3	Coordinate settings (Grasp Planning).....	2-85
2-4-4	Pose of grasping (Grasp Planning).....	2-88
2-4-5	Order of grasping (Grasp Planning).....	2-90
2-4-6	Collision detection (Grasp Planning).....	2-104
2-4-7	Judge cond. (Grasp Planning).....	2-109
2-4-8	Output Parameters (Grasp Planning).....	2-115
2-4-9	Key Points for Test Measurement and Adjustment (Grasp Planning).....	2-116

2-4-10	Measurement Results for Which Output Is Possible (Grasp Planning)	2-119
2-4-11	External Reference Tables (Grasp Planning)	2-120

2-1 FH series 3D robot vision system Processing items

In FH series 3D robot vision system, the processing items that can be used with the FH series are different. The following shows the usability of processing items of FH series 3D robot vision system. Refer to the *Vision System FH/FHV Series Processing Item Function Reference Manual (Cat. No. Z341)*, for information on each processing item other than the FH series 3D robot vision system processing items.



Precautions for Correct Use

FH series 3D robot vision system cannot load data including processing items which it cannot be handled.

2-1-1 Measurement

Processing item	Support	Processing item	Support
3D Search *1	OK	Intersection	OK
Container Detection *1	OK	Color Data	OK
Grasp Planning *1	OK	Gravity and Area	OK
Search	OK	Labeling	OK
Search II	OK	Label Data	-
Flexible Search	OK	Defect	-
Sensitive Search	OK	Precise Defect	OK
ECM Search	-	Fine Matching	OK
EC Circle Search	-	Character Inspection	OK
Shape Search II	-	Date Verification	OK
Shape Search III	OK	Model Dictionary	OK
EC Corner	-	2DCode II	OK
EC Cross	-	2DCode	OK
Classification	OK	Barcode	OK
Edge Position	OK	OCR User Dictionary	OK
Edge Pitch	OK	OCR	OK
Scan Edge Position	OK	Circle Angle	-
Scan Edge Width	OK	Glue Bead Inspection	OK
Circular Scan Edge Position	OK	AI Fine Matching	-
Circular Scan Edge Width	OK		

*1. This is a processing item specific to the FH series 3D robot vision system.

2-2 3D Search

This is a processing item specific to the FH series 3D robot vision system.

Using previously input CAD data of the workpiece, it registers information on surfaces and contours that are seen from various viewpoints as a model, and then detects the position/posture of a workpiece that is most similar to the model based on the input depth map and input image.

For the input image, a dedicated 3D vision sensor and a measurement image from the **Camera Image Input AOS** processing item are required.

Register the CAD data from the **3D Data Manager** processing item as a model.

Used in the Following Case

When measuring the position/posture of the workpiece

Example: Position detection for bulk picking of parts in a container

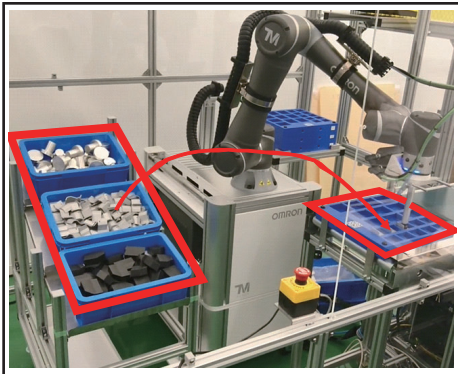

The detected coordinates are passed to the **Grasp Planning** processing item in the measurement flow to convey the pose of grasping to the robot for picking.



Precautions for Correct Use

- If the workpiece has three-dimensionally even surfaces, such as a thin plate, you can also perform 2D imaging simultaneously in the **Camera Image Input AOS** processing item and use information from both the depth map and the raw image (2D) together to improve the horizontal and vertical positioning accuracy.
- Correct measurement is not possible with images that have undergone a coordinate transformation such as Position Compensation or Polar Transformation.

2-2-1 Settings Flow (3D Search)

To set 3D Search, follow the steps below.

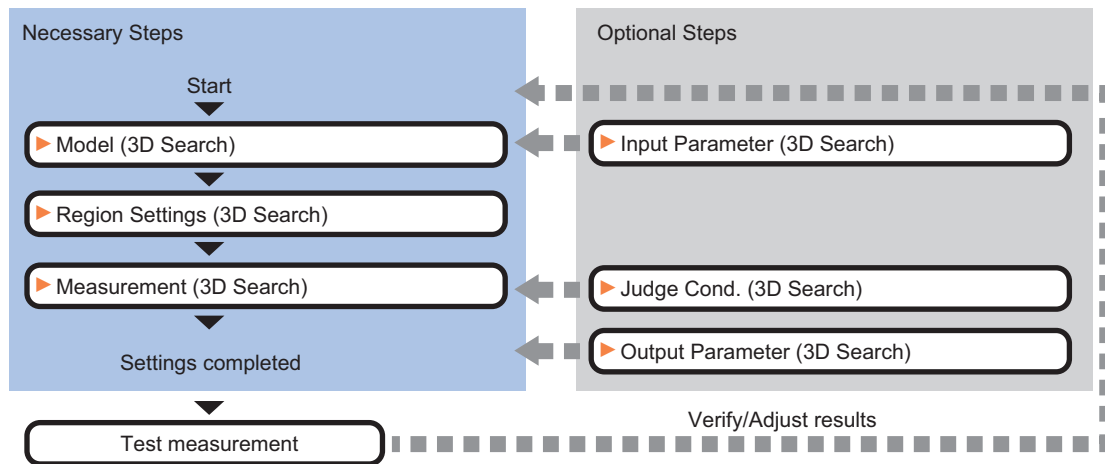

List of 3D Search Items

Item	Description
Input parameter	Check the input parameters. <i>2-2-2 Input parameters (3D Search) on page 2-6</i>
Model	Register the CAD data from the 3D Data Manager processing item as a model. <i>2-2-3 Model (3D Search) on page 2-8</i>
Region settings	Set the measurement area. <i>2-2-4 Region settings (3D Search) on page 2-14</i>
Measurement	Set the measurement conditions as measurement parameters. <i>2-2-5 Measurement (3D Search) on page 2-17</i>
Judge cond.	Set the judgment conditions for the measurement results. Set the extent to which the position/posture values and the correlation value with the model in the measurement results are judged as OK. <i>2-2-6 Judge cond. (3D Search) on page 2-30</i>
Output parameter	Select how to handle the coordinates to be output to the external device as measurement results. This item can be changed as necessary. Normally, the factory default value will be used. <i>2-2-7 Output Parameters (3D Search) on page 2-34</i>

2-2-2 Input parameters (3D Search)

Check the input parameters.

- 1 In the Item tab area, click the **Input parameter** tab.
Check that **Input depth map settings** is set to *Measure image 1* and **Input image settings** is set to *Measure image 0*.

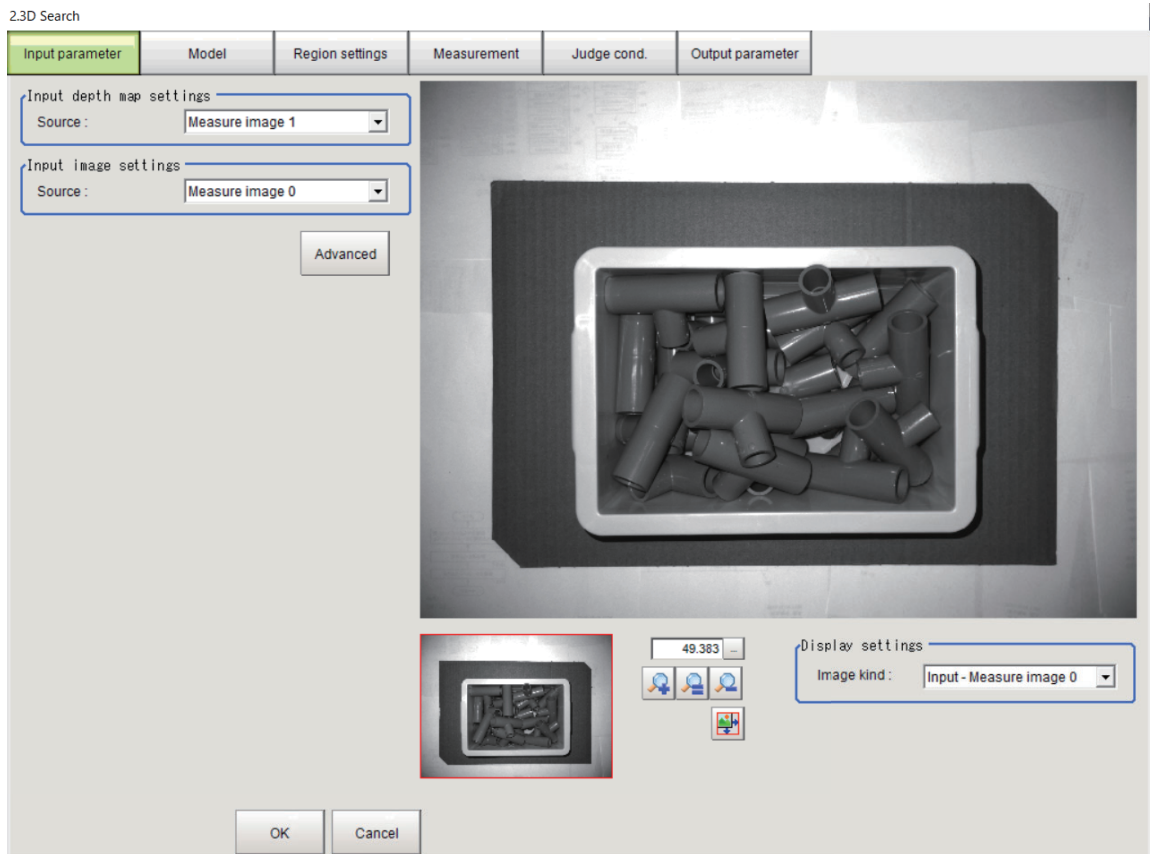

- 2 Click **Advanced**.
In the **3D Imaging unit settings** area, check that the **Camera Image Input AOS** processing item to reference is set.
If they are not set, review the flow and check again.

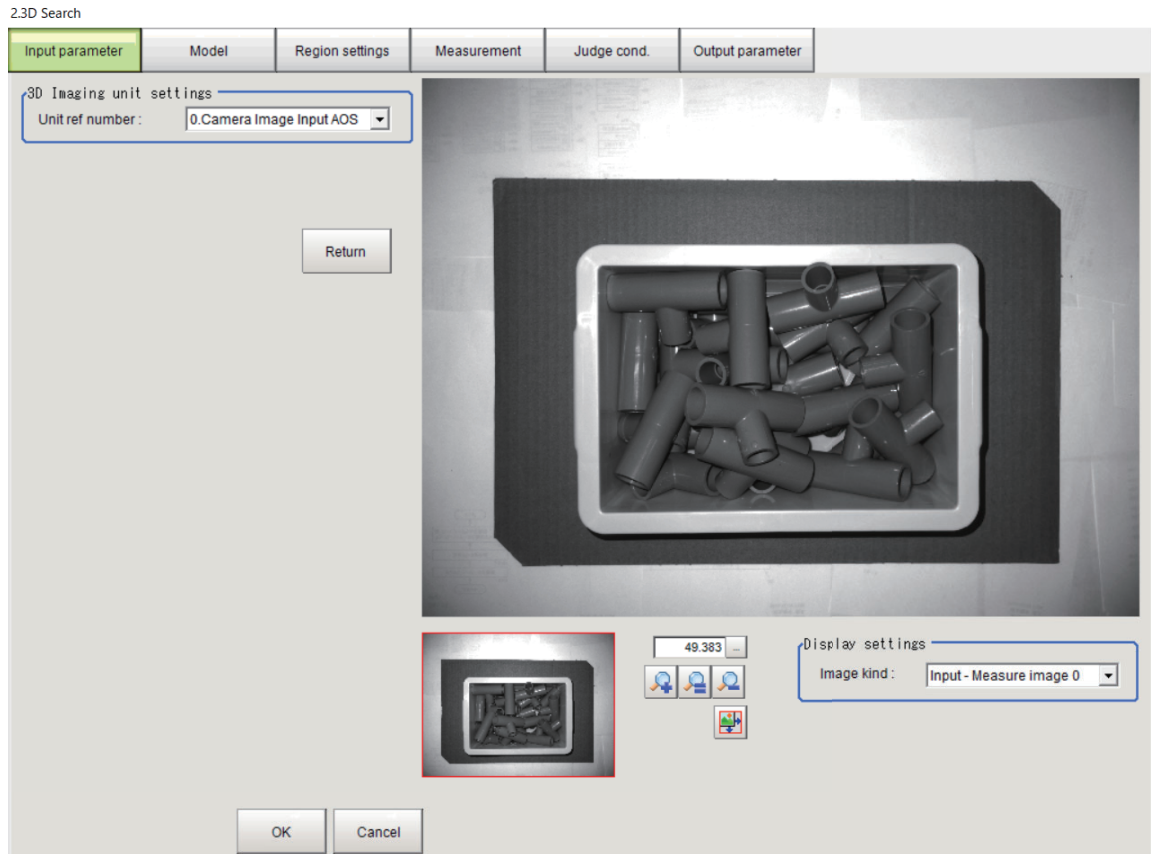

3 Click **Return** to return to the previous menu.

4 In the **Display settings** area, you can change the image to display.

Setting item	Setting value [Factory default]	Description
Image kind	<ul style="list-style-type: none"> [Input - Measure image 0] Camera - Depth image Camera - Captured (2D) Camera - Captured (3D) 	<p>Select the image to display in the Image display area.</p> <ul style="list-style-type: none"> Input - Measure image 0: The input image is displayed. If there are no processing items such as filters, Measurement image 0 from the Camera Image Input AOS processing item is displayed. Camera - Depth image: The distance image from the Camera Image Input AOS processing item is displayed. Camera - Captured (2D): The raw image (2D) from the Camera Image Input AOS processing item is displayed. If the 2D imaging settings are not enabled, the displayed image is completely black. Camera - Captured (3D): The raw image (3D) from the Camera Image Input AOS processing item is displayed. If the 3D imaging settings are not enabled, the displayed image is completely black.

2-2-3 Model (3D Search)

Register the CAD data from the **3D Data Manager** processing item as a model.



Precautions for Correct Use

If the camera is not connected and the calibration data for the camera is not loaded, the CAD data is not registered as a model. Also, the CAD data is not displayed in the image display area.

Model Registration

- 1 In the Item tab area, click **Model**.

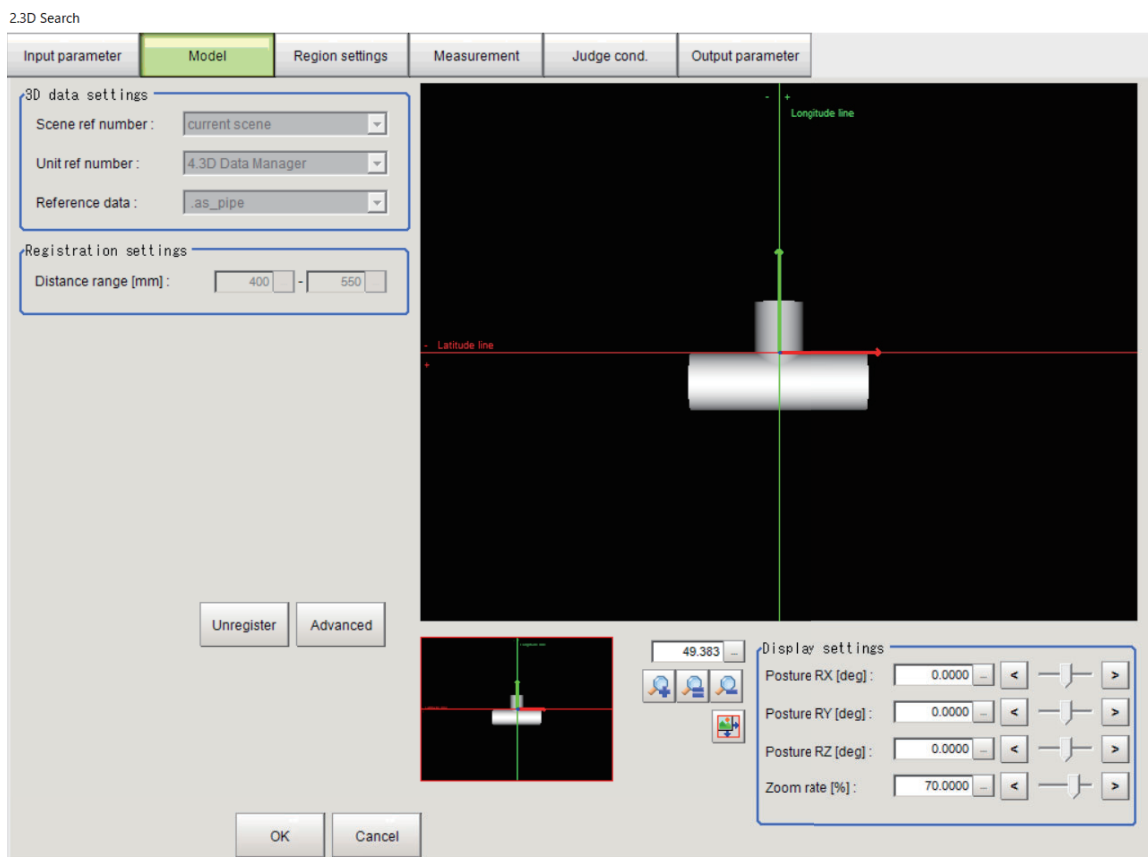

- 2 If the model is already registered, click **Unregister**.
You can now set each item.
- 3 In the **3D data settings** area, select the CAD data of the **3D Data Manager** processing item to reference.

Setting item	Setting value [Factory default]	Description
Scene ref number	-1 to 127 [-1: current scene]	Select the scene number containing the 3D Data Manager processing item holding the CAD data.









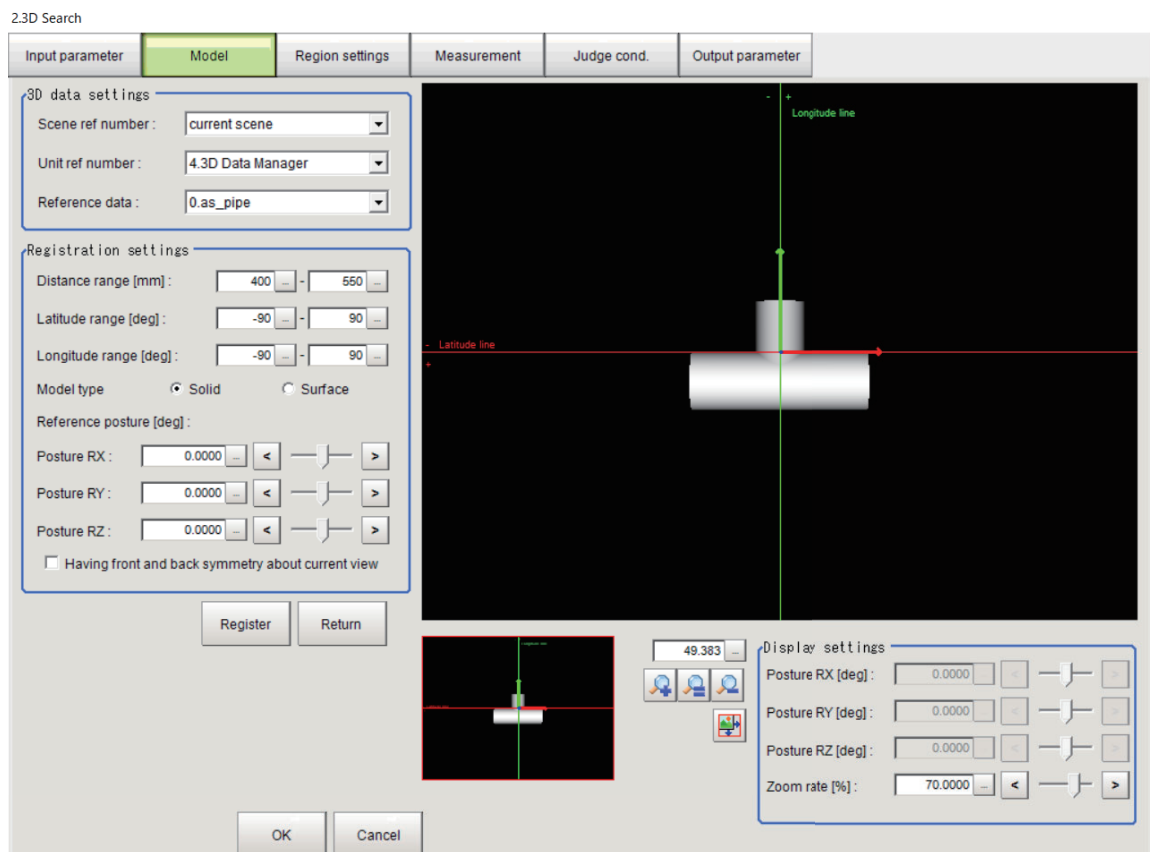

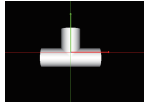
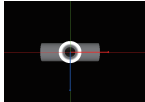
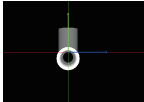

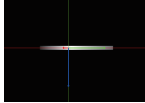
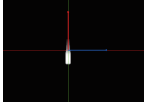



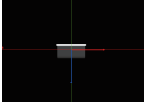

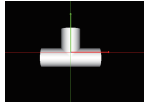
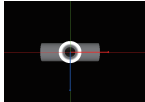
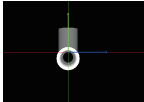

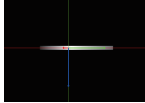
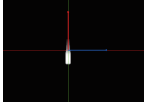

Setting item	Setting value [Factory default]	Description
Unit ref number	-	From among the referenced scene numbers, select the 3D Data Manager processing item to reference.
Reference data	-	Select the CAD data for the referenced 3D Data Manager processing item.

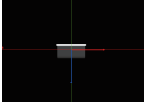
- 4** In the **Registration settings** area, set the **Distance range** of the model to register.

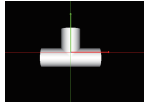
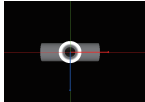
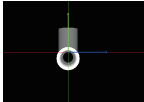
Setting item	Setting value [Factory default]	Description
Distance range [mm]	200 to 2,000 [400] to [550]	Set the range in which the distance of the workpiece seen from the camera can change. The setting range cannot be wider than that of Measurement range of Z in the referenced Camera Image Input AOS processing item. The wider the distance range, the larger the model that you can register.

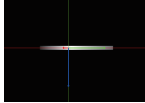
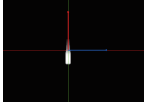
- 5** Click **Advanced** to further set the following items.
Click **Return** to return to the previous menu.

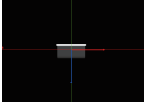

Setting item	Setting value [Factory default]	Description																
Latitude range [deg]	-90 to 90 [-90] to [90]	Set the range in which the view of the workpiece seen from the camera can change.																
Longitude range [deg]	-90 to 90 [-90] to [90]	It is a precondition that the camera in the Reference posture moves on a sphere that is centered at the center of gravity of the workpiece from the initialized positional relationship between the camera and workpiece.																
Model type	<ul style="list-style-type: none"> • [Solid] • Surface 	<p>Specify whether the CAD data to reference uses solid or surface modeling.</p> <ul style="list-style-type: none"> • Solid: The CAD data is treated as consisting of all solids (3D shapes closed with surface data). If the CAD data contains a surface (only one surface), the front side of the surface is registered as a model, but the back side is not registered. • Surface: The CAD data is treated as containing a surface (only one surface). In addition to the front side of the surface, the back side is also registered in the same way (treated as a model with thickness 0). 																
Reference posture [deg]		<p>This parameter is for setting the view of the CAD data when both Latitude and Longitude are set to 0 [deg].</p> <p>If the Reference posture settings are all 0 [deg], the camera and workpiece are positioned so that the Z axis is seen to point to the top and the X axis to the right of the screen in the coordinate system that the CAD data originally has. Specify the amount of change in posture as an XYZ Euler angle. Set the reference posture to the standard posture of the workpiece seen from the camera (or the posture in which the area of the displayed workpiece image is larger) in bulk picking.</p> <p>Example:</p> <table border="0"> <tr> <td>CAD data</td> <td>Correct reference posture</td> <td colspan="2">Incorrect reference posture</td> </tr> <tr> <td></td> <td></td> <td></td> <td></td> </tr> <tr> <td></td> <td></td> <td></td> <td></td> </tr> <tr> <td></td> <td></td> <td></td> <td></td> </tr> </table>	CAD data	Correct reference posture	Incorrect reference posture													
CAD data	Correct reference posture	Incorrect reference posture																
																		
																		
																		
Posture RX	-180.0000 to 180.0000 [0.0000]																	
Posture RY	-180.0000 to 180.0000 [0.0000]																	
Posture RZ	-180.0000 to 180.0000 [0.0000]																	

Setting item	Setting value [Factory default]	Description
Having front and back symmetry about current view	<ul style="list-style-type: none"> • Checked • [Unchecked] 	<p>Set whether the current CAD data has front and back symmetry about the current view.</p> <p>To input (plane-symmetric) CAD data with front and back symmetry, set the CAD data to a posture that provides a front and back symmetric view in Reference posture and check this.</p> <p>However, searching a plane-symmetrical workpiece allows multiple candidates to be detected per workpiece, which degrades the speed performance. If the model data to register has front and back symmetry (plane symmetry), check this to prevent the detection of multiple candidates. This leads to faster and more stable processing.</p>

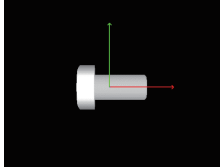
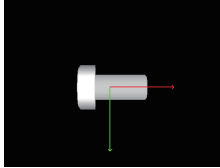
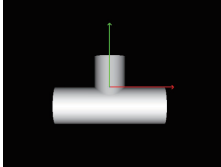
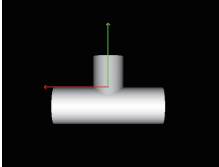
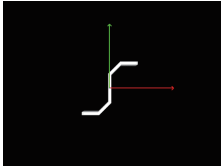
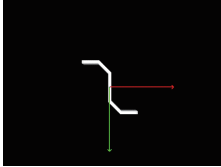
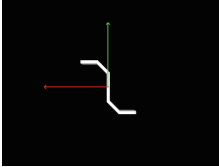
Setting item	Setting value [Factory default]	Description
		<p>A workpiece has front and back symmetry in the following two cases.</p> <p>If the view is the same as before rotation when rotated 180 degrees around the X axis</p> <p>Example:</p> <ul style="list-style-type: none"> <div style="display: flex; justify-content: space-around;"> <div style="text-align: center;"> <p>Before rotation</p>  </div> <div style="text-align: center;"> <p>Rotated 180 degrees around the X axis</p>  </div> </div> <p>If the view is the same as before rotation when rotated 180 degrees around the Y axis</p> <p>Example:</p> <div style="display: flex; justify-content: space-around;"> <div style="text-align: center;"> <p>Before rotation</p>  </div> <div style="text-align: center;"> <p>Rotated 180 degrees around the Y axis</p>  </div> </div> <p>Note that, if you check this when the CAD data does not have front and back symmetry with respect to the reference posture, the CAD data will be recognized as a plane-symmetrical figure with respect to the reference orthogonal plane and detected in an unintended posture.</p> <p>Example:</p> <div style="display: flex; flex-direction: column;"> <div style="display: flex; justify-content: space-around;"> <div style="text-align: center;"> <p>Before rotation</p>  </div> </div> <div style="display: flex; justify-content: space-around; margin-top: 20px;"> <div style="text-align: center;"> <p>Rotated 180 degrees around the X axis</p>  </div> <div style="text-align: center;"> <p>Rotated 180 degrees around the Y axis</p>  </div> </div> </div>



Additional Information

In the model data coordinate system, the Z axis is defined as the positive direction of the Z axis of the coordinate system that the CAD data has, the X axis is defined as the positive direction of the X axis of the camera, and the Y axis is defined as the negative direction of the Y axis of the camera. The origin of the model data coordinate system is set to the center of gravity of the CAD data.

With the model data coordinates in this state, the view seen from a camera located in the positive direction of the Z axis represents the view at latitude 0 [deg] and longitude 0 [deg].

Adjusting the latitude and longitude ranges means to set the range in which the camera can view the workpiece placed in this model data coordinate system while moving on a sphere that is centered at the origin of the model data coordinate system.

Here, the longitude range is defined as the range in which the camera is tilted toward the X axis of the model data coordinate system (left or right of the screen), and the latitude range is defined as the range in which the camera is tilted toward the Y axis of the model data coordinate system (top or bottom of the screen).

Note that changing the reference posture (i.e., changing the view of the workpiece from the camera at latitude 0 [deg] and longitude 0 [deg]) does not cause the axes of the model data coordinate system (latitude and longitude axes) to rotate together.

Camera coordinate system

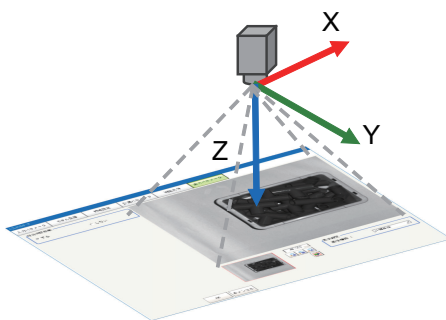

Model data coordinate system



6 Click **Register**.

Under registering is displayed. UI operations are not accepted during model registration.

The model is registered according to the set value.

Checking the Model Status on the Image (Display Settings)

By changing the display settings, you can check the status of the model registered on the image.



Additional Information

You cannot set the reference posture in the Display Settings area. To set the reference posture, click **Advanced**.

- 1 Set the value in the **Display settings** area.

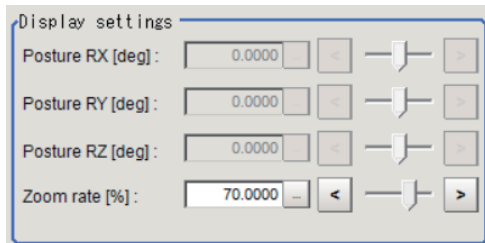

Setting item	Setting value [Factory default]	Description
Posture RX [deg]	-180.0000 to 180.0000 [0.0000]	Posture of the CAD data displayed on the setting screen (X-axis rotation amount in XYZ Euler angle)
Posture RY [deg]	-180.0000 to 180.0000 [0.0000]	Posture of the CAD data displayed on the setting screen (Y-axis rotation amount in XYZ Euler angle)
Posture RZ [deg]	-180.0000 to 180.0000 [0.0000]	Posture of the CAD data displayed on the setting screen (Z-axis rotation amount in XYZ Euler angle)
Zoom rate [%]	1.0000 to 100.0000 [70.0000]	Zoom rate of the CAD data displayed on the setting screen "1" indicates the zoom rate when seen from the upper-limit side of the registration distance of the model, and "100" (or "200" [mm] if the lower limit is less than 200 [mm]) indicates the zoom rate when seen from the lower-limit side of the registration distance of the model. Changing the value of Distance range [mm] in Model Registration changes the meaning of the zoom rate value.

- 2 Check the status of the registered model in the image, and then register the model again.

2-2-4 Region settings (3D Search)

Use a rectangle to specify the area where the model is searched.

Instead of measuring the entire input image, narrowing the measurement area shortens the processing time.

- 1 In the Item tab area, click **Region settings**.

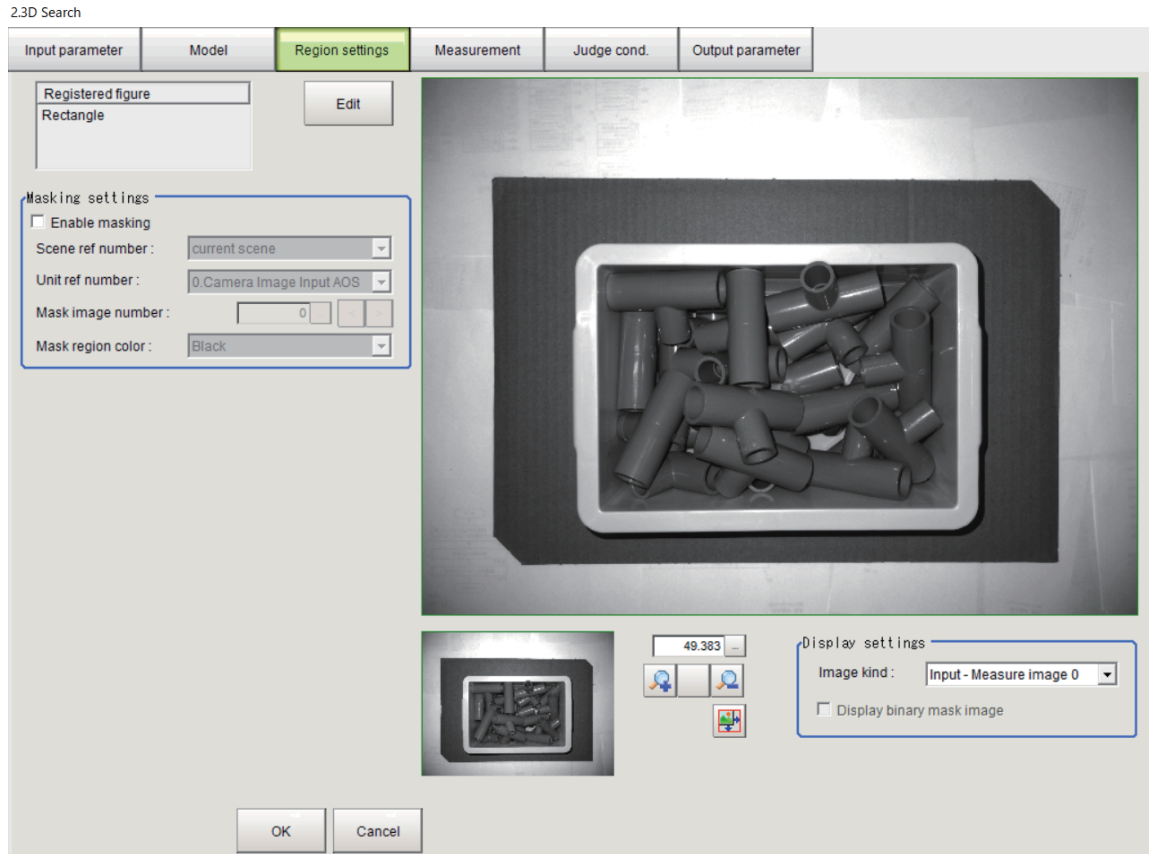

- 2 Click **Edit**.
The *Figure Setting* area is displayed.
- 3 Specify the area in which to search for the model.
The rectangle covering the entire screen is set. Adjust the size and position of the rectangle.
- 4 Click **OK** in the *Figure setting* area.
 - **OK**: Changes the settings and returns to the previous menu.
 - **Cancel**: Changes are discarded. Returns to the previous menu.
 - **Apply**: Updates the settings without leaving edit window.
- 5 In the **Masking settings** area, you can use the mask.
To limit the area to search to the area inside the container, refer to the mask image for the container detection scene in the **Container Detection** processing item. The mask image in the **Container Detection** processing item is a binary image, where the area inside the container has 255 and the other regions have 1.
If you set a mask image, the area where the measurement area and the mask on the mask image overlap is the area to search.



- Measurement area
- Mask
- Area to search

Setting item	Setting value [Factory default]	Description
Enable masking	<ul style="list-style-type: none"> • Checked • [Unchecked] 	Check this to use the image held by a particular unit as a mask. The pixel area specified in Mask image number and Mask region color is masked and excluded from the measurement region.
Scene ref number	-1 to 127 [-1: current scene]	Specify the scene number of the unit holding the image referenced as a mask.
Unit ref number	-	Specify the unit number of the unit holding the image referenced as a mask.
Mask image number	0 to 31 [0]	Specify the image number of the image referenced as a mask.
Mask region color	<ul style="list-style-type: none"> • [Black] • White • Red • Blue • Green 	Specify the pixel color by which to specify the pixel area used as a mask in the image referenced as a mask. The specified pixel area is masked and excluded from the measurement region.

6 In the **Display settings** area, you can change the image to display.

Setting item	Setting value [Factory default]	Description
Image kind	<ul style="list-style-type: none"> • [Input - Measure image 0] • Camera - Depth image • Camera - Captured (2D) • Camera - Captured (3D) 	Select the image to display in the Image display area. <ul style="list-style-type: none"> • Input - Measure image 0: The input image is displayed. If there are no processing items such as filters, Measurement image 0 from the Camera Image Input AOS processing item is displayed. • Camera - Depth image: The distance image from the Camera Image Input AOS processing item is displayed. • Camera - Captured (2D): The raw image (2D) from the Camera Image Input AOS processing item is displayed. If the 2D imaging settings are not enabled, the displayed image is completely black. • Camera - Captured (3D): The raw image (3D) from the Camera Image Input AOS processing item is displayed. If the 3D imaging settings are not enabled, the displayed image is completely black.

Setting item	Setting value [Factory default]	Description
Display binary mask image	<ul style="list-style-type: none"> Checked [Unchecked] 	<ul style="list-style-type: none"> Checked: A binary image of with effective pixels drawn in white and the rest in black is displayed in the Image display area. Unchecked: An image set in Image kind is displayed.

2-2-5 Measurement (3D Search)

Set the measurement conditions as measurement parameters.



Setting the Measurement Conditions

Set the necessary parameters and processing conditions for the measurement.

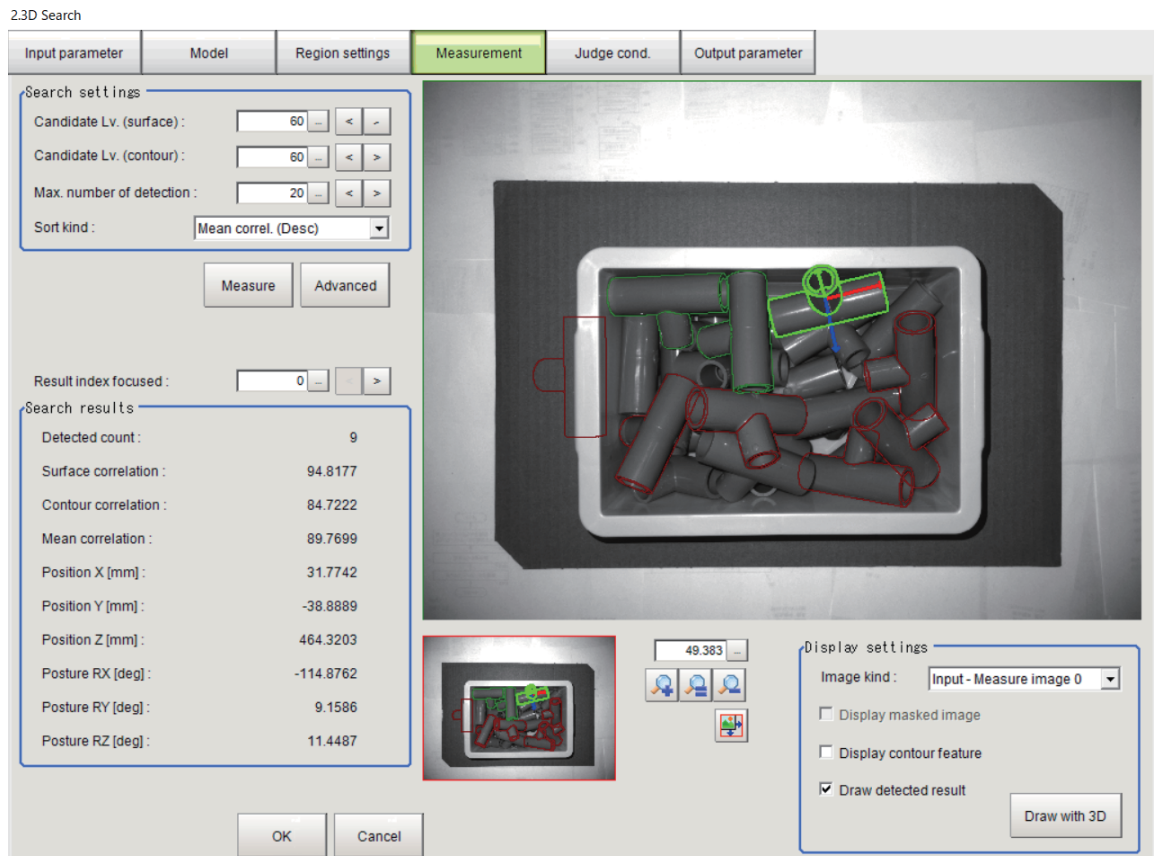
- 1 In the Item tab area, click **Measurement**.

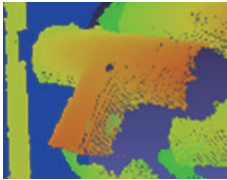

- 2 Set the value in the **Search settings** area.

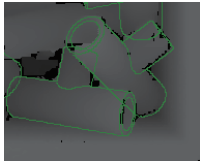
Setting item	Setting value [Factory default]	Description
Candidate Lv. (surface)	1 to 99 [60]	<p>Specify the match threshold for the surface to detect. Surface match refers to a feature value that becomes high when the detected point cloud in the 3D data matches the surface information (pose/direction) in the CAD data.</p> <p>Example: Detected point cloud in the 3D data</p>  <p>Surface information in the CAD data (white to gray pixels)</p>  <p>If there is a data loss in the detected point cloud in the 3D data of the workpiece, the surface correlation value is low.</p>  <p>If the workpiece is partially hidden due to the bulk condition, the surface and contour correlation values are low.</p>  <p>When detecting a workpiece that consists of only planes, if multiple planes such as the top and side surfaces are not measured, the required positioning accuracy may not be obtained in the direction of sliding on the planes even if the surface match is high. If so, check it by contour match. A workpiece will be detected when it exceeds the surface match or contour match threshold. Note that not only workpieces that exceed both thresholds are detected. If both thresholds are exceeded, it will be displayed in green. If either threshold is exceeded, it will be displayed in red. To use only the results that exceed both thresholds, utilize the judgment conditions.</p>

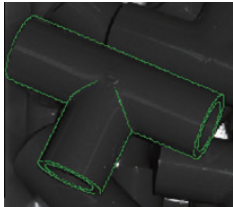
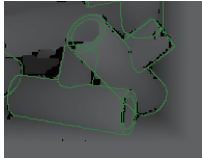
Setting item	Setting value [Factory default]	Description
Candidate Lv. (contour)	1 to 99 [60]	<p>Specify the match threshold for the contour to detect. Contour match refers to a feature value that becomes high when the pose/direction of the detected edges match those of the edges in the CAD data.</p> <p>Example: Detected edges</p>  <p>Edges in the CAD data (Green lines)</p>  <p>If the workpiece is partially hidden due to the bulk condition, the surface and contour correlation values are low.</p>  <p>Note that, depending on the Edge info. used setting, the location of edge extraction from the contours of the measurement target for a match changes.</p> <p>Note that, depending on the Edge level setting, the degree of edge extraction from the contour of the measurement target for a match changes.</p> <p>A workpiece will be detected when it exceeds the surface match or contour match threshold. Note that not only workpieces that exceed both thresholds are detected. If both thresholds are exceeded, it will be displayed in green. If either threshold is exceeded, it will be displayed in red. To use only the results that exceed both thresholds, utilize the judgment conditions.</p>
Max. number of detection	1 to 128 [20]	<p>Set the maximum number of detection targets. When the number of detected contours is equal to or more than "Detected count", the detection results are sorted and output as many as the detected count from the top.</p>

Setting item	Setting value [Factory default]	Description
Sort kind	<ul style="list-style-type: none"> • [Mean correl. (Desc)] • Mean correl. (Asc) • Surface correl. (Desc) • Surface correl. (Asc) • Contour correl. (Desc) • Contour correl. (Asc) • Position X (Desc) • Position X (Asc) • Position Y (Desc) • Position Y (Asc) • Position Z (Desc) • Position Z (Asc) 	<p>Set the conditions for sorting the multiple candidates detected.</p> <p>Positions X, Y, and Z refer to the origin of the CAD coordinate system seen from the camera coordinate system.</p>

- 3** Click **Advanced**. Set the value in the **Search settings** area.
Click **Return** to return to the previous menu.

Search settings

Candidate Lv. (surface) :

Candidate Lv. (contour) :

Max. number of detection :

Sort kind :

Edge info. used : Depth Image

Edge level (depth) : Auto

Edge level (image) : Auto

Latitude range [deg] : -



Longitude range [deg] : -

Roll range [deg] : -

Distance range [mm] : -

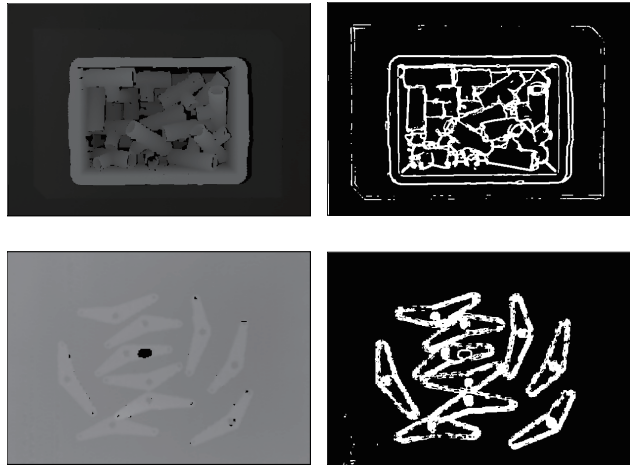
Result index focused :

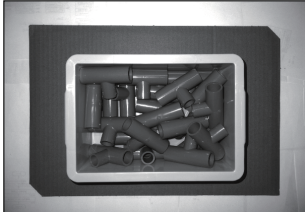
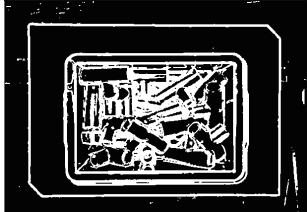
Setting item	Setting value [Factory default]	Description
Edge info. used	<ul style="list-style-type: none"> • [Depth] • Image 	<p>Set the edge information that is used when extracting edges.</p> <ul style="list-style-type: none"> • Depth: Contours are extracted from the height information in the input depth map. <p>For workpieces with three-dimensional uneven surfaces, extracting the edges from the height information improves the positioning accuracy.</p> <p>Example:</p> <p>Measurement image (3D) Contour feature image extracted from the measurement image</p> 

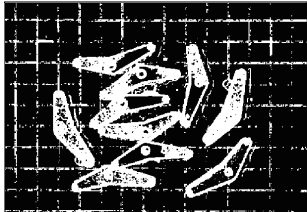
Setting item	Setting value [Factory default]	Description
		<ul style="list-style-type: none"> Image: Contours are extracted from the density information in the input image. For workpieces without three-dimensional uneven surfaces such as thin plates, extracting the edges from the image information improves the positioning accuracy. To do so, you need to check in advance 2D imaging ON in Camera settings in the Camera setting(2D) tab for the referenced Camera Image Input AOS processing item. It is also required that the positional relationship on the image must be the same between the input depth map and the measurement image (2D). Therefore, correct measurement is not possible if you perform a coordinate transformation on the captured measurement image (2D) in the Position Compensation processing item, etc. Example: <p>Measurement image (2D) Contour feature image extracted from the measurement image</p> <div style="display: flex; flex-wrap: wrap;"> <div style="width: 50%; text-align: center;">  </div> <div style="width: 50%; text-align: center;">  </div> <div style="width: 50%; text-align: center;">  </div> <div style="width: 50%; text-align: center;">  </div> </div>

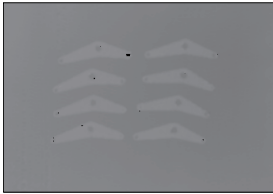
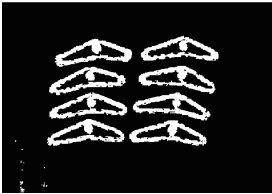
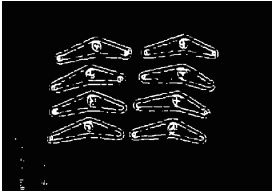
Setting item	Setting value [Factory default]	Description
Edge level (depth)	[Auto], 1.0000 to 1,000.0000 [mm]	<p>This setting is enabled when the Edge info. used is <i>Depth</i>. Set the degree of edge extraction to extract contours from height information in the input depth map.</p> <p>Set the lower limit of edge level to recognize as edge. Edges are recognized when their edge level is above this value. The smaller the value, the easier it is to find edges. The larger the value, the less noise will affect finding edges.</p> <p>Check <i>Auto</i> to set the edge level automatically.</p> <p>Example:</p> <div style="display: flex; justify-content: space-around; align-items: flex-start;"> <div style="text-align: center;"> <p>Measurement image (3D)</p>  </div> <div style="text-align: center;"> <p>Contour feature image extracted from the measurement image</p>  </div> </div> <p>Contour features cannot be detected if the value is too small.</p> <div style="text-align: center;">  </div>

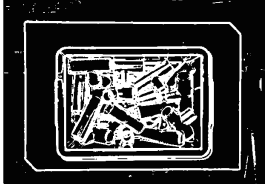
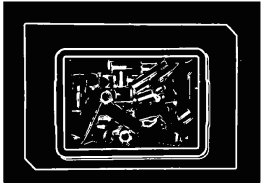
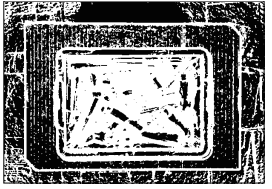
Setting item	Setting value [Factory default]	Description
Edge level (image)	[Auto], 1 to 1,000	<p>This setting is enabled when the Edge info. used is <i>Image</i>. Set the degree of edge extraction to extract edges from the input image.</p> <p>Set the lower limit of edge level to recognize as edge. Edges are recognized when their edge level is above this value. The smaller the value, the easier it is to find edges. The larger the value, the less noise will affect finding edges. The unit is difference in density.</p> <p>If <i>Auto</i> is checked, a fixed value of 30 is set.</p> <p>Example:</p> <p>Measurement image (2D)</p>   <p>Contour feature image extracted from the measurement image</p> <p>Contour features cannot be detected if the value is too small.</p>  <p>Contour feature image can be falsely detected if the value is too large.</p> 
Latitude range [deg]	-90 to 90 [-90] to [90]	<p>Set the range of view (latitude and longitude) of the work-piece to search, with the view in the reference posture that you set in Model to 0 [deg].</p> <p>The setting range is limited to the setting range for model registration. Each time you perform a model registration, this is initialized to the setting range for model registration.</p>
Longitude range [deg]	-90 to 90 [-90] to [90]	

Setting item	Setting value [Factory default]	Description
Roll range [deg]	-180 to 180 [-180] to [180]	<p>Set the range of view (rotation around the optical axis) of the workpiece to search, with the view in the reference posture that you set in Model to 0 [deg]. Candidates in the set value range will be detected.</p> <p>To limit the search range to around the viewpoint from a certain direction to search for rotation on the image in the Shape Search III processing item, the following settings are required.</p> <ul style="list-style-type: none"> • At the time of model registration, check Having front and back symmetry about current view to limit the search range to only one hemisphere of the spherical search range. • Set the latitude and longitude ranges to about ± 30 [deg] to limit the viewpoint. (Narrow the viewpoint as shown by the red cone in the figure below.) • Determine the search range around the viewpoint. <div data-bbox="783 862 1211 1189"> </div> <p>Example:</p> <p>Reference posture in model registration</p> <div data-bbox="794 1328 991 1464"> </div> <p>Search results</p> <p>Correctly recognized posture with narrow range settings</p> <div data-bbox="794 1592 1433 1727"> </div> <p>Incorrectly recognized posture with wide range settings</p> <div data-bbox="794 1816 1433 1951"> </div>

Setting item	Setting value [Factory default]	Description
Distance range [mm]	50 to 5,000 [400] to [550]	Set the range of view of the workpiece to search (the distance of the workpiece seen from the camera). The setting range is limited to the setting range for model registration. Each time you perform a model registration, this is initialized to the setting range for model registration.

- 4** When the setting has been changed, click **Measure** to verify whether measurement can be performed correctly.

Setting item	Setting value [Factory default]	Description
Result index focused	0 to 127 [0]	This indicates the search result number. You can select only one number to display the final detection results. The detection results are displayed according to the set number. The selected workpiece is highlighted.

Item	Description
Detected count	Detection count with the current settings
Surface correlation	Surface correlation value in the search results, which is set in Result index focused
Contour correlation	Contour correlation value in the search results, which is set in Result index focused
Mean correlation	Mean surface and contour correlation value in the search results, which is set in Result index focused
Position X [mm]	Position in the search results, which is set in Result index focused (the position of the origin of the CAD coordinate system seen from the camera coordinate system)
Position Y [mm]	
Position Z [mm]	
Posture RX [deg]	Posture in the search results, which is set in Result index focused (the posture in the CAD coordinate system seen from the camera coordinate system)
Posture RY [deg]	
Posture RZ [deg]	

Checking Measurement Results in the Image (Display Settings)

You can change the display settings to check the processing conditions for measurements on the image.

- 1** Set the value in the **Display settings** area.

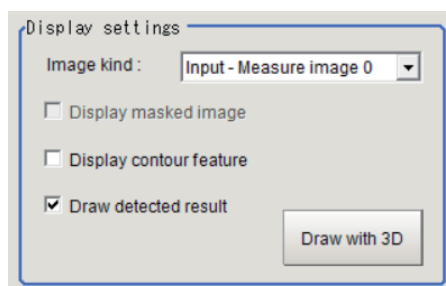

Setting item	Setting value [Factory default]	Description
Image kind	<ul style="list-style-type: none"> • [Input - Measure image 0] • Camera - Depth image • Camera - Captured (2D) • Camera - Captured (3D) 	<p>Select the image to display in the Image display area.</p> <ul style="list-style-type: none"> • Input - Measure image 0: The input image is displayed. If there are no processing items such as filters, Measurement image 0 from the Camera Image Input AOS processing item is displayed. • Camera - Depth image: The distance image from the Camera Image Input AOS processing item is displayed. • Camera - Captured (2D): The raw image (2D) from the Camera Image Input AOS processing item is displayed. If the 2D imaging settings are not enabled, the displayed image is completely black. • Camera - Captured (3D): The raw image (3D) from the Camera Image Input AOS processing item is displayed. If the 3D imaging settings are not enabled, the displayed image is completely black.
Display masked image	<ul style="list-style-type: none"> • Checked • [Unchecked] 	Check this to display the image that you set in the Masking settings area in the Region settings tab.
Display contour feature	<ul style="list-style-type: none"> • Checked • [Unchecked] 	Check this to display the contour feature image extracted from the measurement image.
Draw detected result	<ul style="list-style-type: none"> • [Checked] • Unchecked 	Check this to display the contour figures and coordinate axes of all detected workpieces.
Draw with 3D	-	<p>Click this to start the 3D result display tool FZ-3DVisualizer. The 3D result display tool FZ-3DVisualizer displays measurement point clouds in 3D and applies the original CAD data to all the positions/postures detected in the search results in 3D to display them in 3D.</p> <p>Refer to <i>Checking 3D Measurement Results (FZ-3DVisualizer)</i> on page 1-13.</p>

2 Check the conditions of measurement processing on the image and set the measurement parameters.

● Checking 3D Measurement Results (FZ-3DVisualizer)

FZ-3DVisualizer is a result display tool that draws 3D point clouds, recognized workpieces, recognized pose of grasping, etc. in 3D space. Use this tool to check the detection results for the **3D Search** and **Grasp Planning** processing items to see if objects are detected in appropriate positions in 3D space.

FZ-3DVisualizer

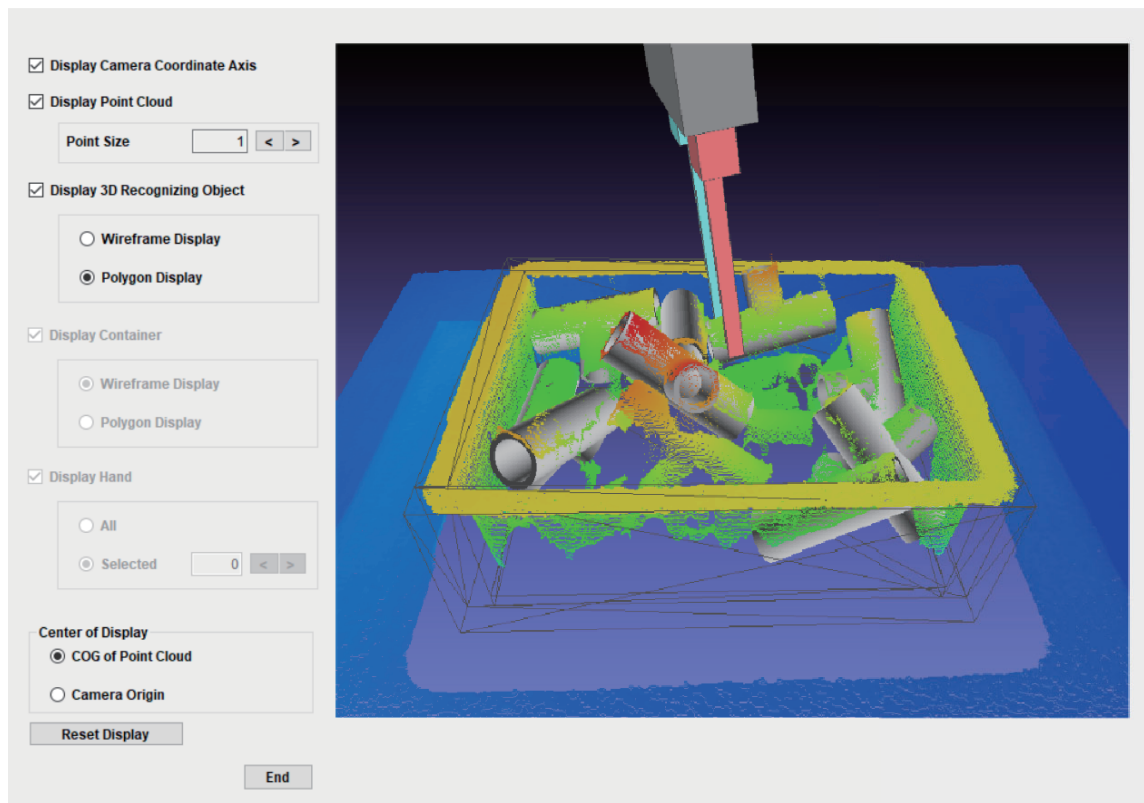

3D objects are displayed in the image display area.

Operation	Description
Left-click + Drag	You can move the viewpoint by rotating the image around the display center of the image display area.
Mouse wheel scroll	You can zoom in and out the image around the display center of the image display area.
Middle click + Drag or Shift key + Left-click + Drag	You can move the display center of the image display area.

Item	Description
Display Camera Coordinate Axis	Show or hide the camera coordinate axes.
Display Point Cloud	Show or hide the point cloud data.
Point Size	Change the size of the displayed point cloud. The point cloud size range is 1 to 5.
Display 3D Recognizing Object	Show or hide the workpiece recognized in the 3D Search processing item.
Wireframe Display	Set the workpiece display format to wireframe display.
Polygon Display	Set the workpiece display format to polygon display.
Display Container	Show or hide the container detected in the Container Detection processing item. It cannot be set in the 3D Search processing item.
Wireframe Display	Set the workpiece display format to wireframe display.
Polygon Display	Set the workpiece display format to polygon display.

Item	Description
Display Hand	Show or hide the pose of grasping calculated in the Grasp Planning processing item. It cannot be set in the 3D Search processing item.
All	All candidates are displayed at the same time.
Selected	One of the candidates for the specified measurement result number is displayed.
Center of Display	Switch the display center of the image display area between the center of gravity of the point cloud (center of gravity XYZ of the point cloud data) and the camera origin.
COG of Point Cloud	
Camera Origin	
Reset Display	Reset the display position of the image display area to the initial position.
End	Close the FZ-3DVisualizer tool.

2-2-6 Judge cond. (3D Search)

Set the judgment conditions for the measurement results.

Set the upper and lower values to judge the measurement result. When the measurement result value is within the upper and lower values, Judgment is OK (pass). When the measurement result value exceeds either the upper or lower value Judgment is NG (failure). Although the judgment result for the processing Unit is OK when the judgment for all measurements is OK, it will be NG if any measurement result is NG.

- 1 In the Item tab area, click **Judge cond.**.

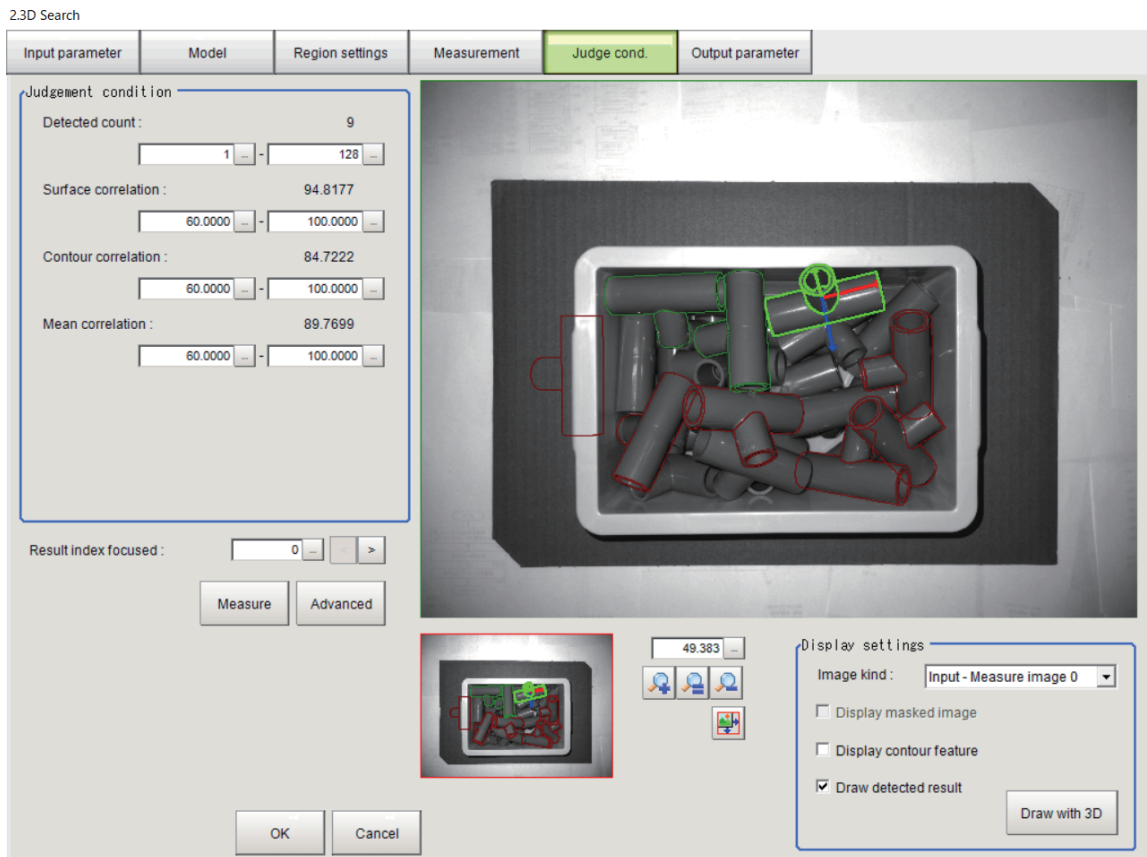

- 2 Set the value in the **Judgement condition** area.

Setting item	Setting value [Factory default]	Description
Detected count	1 to 128 [1] to [128]	Sets the upper and lower values of number of Model to detect.
Surface correlation	0.0000 to 100.0000 [60.0000] to [100.0000]	Sets the upper and lower limit values for the surface correlation to Model to detect.
Contour correlation	0.0000 to 100.0000 [60.0000] to [100.0000]	Sets the upper and lower limit values for the contour correlation to Model to detect.
Mean correlation	0.0000 to 100.0000 [60.0000] to [100.0000]	Sets the upper and lower limit values for the mean correlation to Model to detect.

Setting item	Setting value [Factory default]	Description
Result index focused	0 to 127 [0]	This indicates the search result number. You can select only one number to display the final detection results. The detection results are displayed according to the set number. The selected workpiece is highlighted.

- 3** Click **Advanced**. Set the value in the **Judgement condition** area.
Click **Return** to return to the previous menu.

Judgement condition

Position X [mm] : 31.7742
 -

Position Y [mm] : -38.8889
 -

Position Z [mm] : 464.3203
 -

Posture RX [deg] : -114.8762
 -

Posture RY [deg] : 9.1586
 -

Posture RZ [deg] : 11.4487
 -

Result index focused :

Setting item	Setting value [Factory default]	Description
Position X [mm]	-10,000.0000 to 10,000.0000 [-10,000.0000] to [10,000.0000]	Set the range of coordinates to judge as OK.
Position Y [mm]	-10,000.0000 to 10,000.0000 [-10,000.0000] to [10,000.0000]	
Position Z [mm]	-10,000.0000 to 10,000.0000 [-10,000.0000] to [10,000.0000]	

Setting item	Setting value [Factory default]	Description
Posture RX [deg]	-180.0000 to 180.0000 [-180.0000] to [180.0000]	Set the range of angles to judge as OK.
Posture RY [deg]	-180.0000 to 180.0000 [-180.0000] to [180.0000]	
Posture RZ [deg]	-180.0000 to 180.0000 [-180.0000] to [180.0000]	

- 4** When the setting has been changed, click **Measure** to verify whether measurement can be performed correctly.

Checking Measurement Results in the Image (Display Settings)

You can change the display settings to check the processing conditions for measurements on the image.

- 1** Set the value in the **Display settings** area.

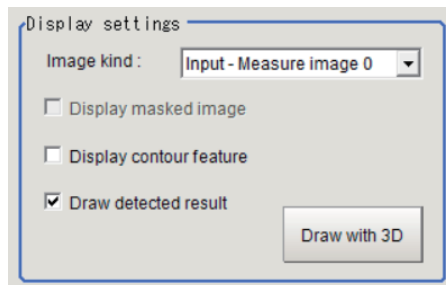

Setting item	Setting value [Factory default]	Description
Image kind	<ul style="list-style-type: none"> [Input - Measure image 0] Camera - Depth image Camera - Captured (2D) Camera - Captured (3D) 	<p>Select the image to display in the Image display area.</p> <ul style="list-style-type: none"> Input - Measure image 0: The input image is displayed. If there are no processing items such as filters, Measurement image 0 from the Camera Image Input AOS processing item is displayed. Camera - Depth image: The distance image from the Camera Image Input AOS processing item is displayed. Camera - Captured (2D): The raw image (2D) from the Camera Image Input AOS processing item is displayed. If the 2D imaging settings are not enabled, the displayed image is completely black. Camera - Captured (3D): The raw image (3D) from the Camera Image Input AOS processing item is displayed. If the 3D imaging settings are not enabled, the displayed image is completely black.

Setting item	Setting value [Factory default]	Description
Display masked image	<ul style="list-style-type: none"> • Checked • [Unchecked] 	Check this to display the image that you set in the Masking settings area in the Region settings tab.
Display contour feature	<ul style="list-style-type: none"> • Checked • [Unchecked] 	Check this to display the contour feature image extracted from the measurement image.
Draw detected result	<ul style="list-style-type: none"> • [Checked] • Unchecked 	Check this to display the contour figures and coordinate axes of all detected workpieces.
Draw with 3D	-	Click this to start the 3D result display tool FZ-3DVisualizer . The 3D result display tool FZ-3DVisualizer displays measurement point clouds in 3D and applies the original CAD data to all the positions/postures detected in the search results in 3D to display them in 3D. Refer to <i>Checking 3D Measurement Results (FZ-3DVisualizer)</i> on page 1-13.

- 2 Check the conditions of measurement processing on the image and set the measurement parameters.

2-2-7 Output Parameters (3D Search)

Select how to handle the coordinates to be output to the external device as measurement results. This item can be changed as necessary. Normally, the factory default value will be used.

- 1 In the Item tab area, click **Output parameter**.
- 2 Select the *Reflect to overall judgment*.

Setting item	Setting value [Factory default]	Description
Reflect to overall judgment	<ul style="list-style-type: none"> • [ON] • OFF 	-

2-2-8 Key Points for Test Measurement and Adjustment (3D Search)

The following content is displayed in the *Detail result* area as text.



Precautions for Correct Use

Executing test measurements will also update the measurement results and the figures in the image.

Displayed item	Description
Judge	Judgment result 0: No judgment (unmeasured) 1: Judgment result OK -1: Judgment result NG -10: Error (image format mismatch) -11: Error (unregistered model) -12: Error (insufficient memory) -20: Error (other errors)

Displayed item	Description
Detected count	Count
Surface correlation	Surface correlation
Contour correlation	Contour correlation
Mean correlation	Mean correlation
Position X [mm]	Position X
Position Y [mm]	Position Y
Position Z [mm]	Position Z
Posture RX [deg]	Posture RX
Posture RY [deg]	Posture RY
Posture RZ [deg]	Posture RZ
Posture type	This represents the detected Eulerian coordinate system. In this processing item, it is always XYZ (2).

The image specified in the Sub-image number in the image display setting is displayed in the *Image Display* area.

Sub-image number	Description of image to be displayed
0	Figures other than the region figure are superimposed on the measurement image.
1	Figures other than the region figure are superimposed on the masked measurement image.
2	All figures are superimposed on the measurement image.
3	All figures are superimposed on the masked measurement image.
4	The measurement result figure is superimposed on the measurement image.
5	The measurement result figure is superimposed on the masked measurement image.
6	The region figure and the measurement result figure are superimposed on the measurement image.
7	The region figure and the measurement result figure are superimposed on the masked measurement image.
8	The coordinate axis figure of the recognized posture is superimposed on the measurement image.
9	The coordinate axis figure of the recognized posture is superimposed on the masked measurement image.
10	The region figure and the coordinate axis figure of the recognized posture are superimposed on the measurement image.
11	The region figure and the coordinate axis figure of the recognized posture are superimposed on the masked measurement image.

Key Points for Adjustment (3D Search)

Adjust the setting parameters referring to the following points.

● When the model registration fails

Parameter to be adjusted	Remedy
Model	If a memory allocation failure error occurs, the amount of information on the model to register may be too large. Set the distance and angle ranges so that the actual detection ranges are not exceeded.

Parameter to be adjusted	Remedy
-	If the camera is not connected and the calibration data for the camera is not loaded in the Camera Image Input AOS processing item, the CAD data is not registered as a model. Also, the CAD data is not displayed in the image display area. Confirm the Select camera - Camera information in the Camera Image Input AOS processing item.

● **When the model registration takes a long time**

Parameter to be adjusted	Remedy
Model	The amount of information on the model to register may be too large. Set the distance and angle ranges so that the actual detection ranges are not exceeded.
-(CAD data)	The amount of mesh in the CAD data may be too large. Open the STL file in CAD software and check if the mesh is not too dense. Reduce the amount of mesh, if possible.

● **When the Judgment Result is NG (unregistered model)**

Parameter to be adjusted	Remedy
Model - 3D data settings Measurement flow	The referenced 3D Data Manager processing item may be deleted. Set the reference relationship with the 3D Data Manager processing items again.
Model	The referenced CAD data may be edited and caused a mismatch with the registered model. Register the model again. The 2D imaging ON setting may have changed in the Camera Image Input AOS processing item. Register the model again.

● **When the Judgment Result is NG (Insufficient Memory)**

Parameter to be adjusted	Remedy
Detected count Measurement flow	Temporary memory to store the measurement results for the number of detection targets may not be secured when the maximum number of detection targets and the image size are set to large values. After restarting the FH series Sensor Controller, reduce the Detected count in the Measurement tab. Alternatively, reduce the memory usage of the entire system, for example, by reducing the number of registered scenes.
Region settings Measurement flow	Because the measurement image is too large, temporary memory may not be secured in mask image generation, etc. After restarting the FH series Sensor Controller, uncheck Enable masking in the Region settings tab. Alternatively, reduce the memory usage of the entire system, for example, by reducing the number of registered scenes.

● **When the measurement results are unstable / When the workpiece are not be detected**

Parameter to be adjusted	Remedy
Model	Due to the replacement of the camera, the camera parameters may be changed. Register the model again.

Parameter to be adjusted	Remedy
Judge cond.	The workpiece may not be detected because the surface correlation values or plane correlation values in the search settings are too high. Reduce the set values of the judgment conditions, or change the judgment condition settings according to the detected matches.
Region settings	The workpiece may not be detected because the measurement region is incorrect. Set the measurement region to the location to search.
Region settings	The workpiece may not be detected because the mask is not specified correctly. When Display binary mask image is checked in the Region settings , make the masking settings while checking that the mask is applied to the area to detect.
Model	The detection target cannot be detected or may have low correlation values due to a deviation between the model and the detection target. Check that the CAD data registered as a model agrees with the dimensions of the detection target. Then, use the CAD data that agrees with the detection target to register the model.
Edge info. used	Because Edge info. used is set incorrectly, the detection target cannot be detected or may have low correlation values. Check the Edge info. used setting. <i>2-2-5 Measurement (3D Search)</i> on page 2-17
Input Image	Because the image from which to extract edges is not correct when Edge info. used is set to <i>Image</i> , the detection target cannot be detected or may have low correlation values. Set this so that the input image is suitable for the edges to extract. If the Position Compensation processing item is included between this and the Camera Image Input AOS processing item, use Measurement Image Switching , etc. to input the image before position compensation.

2-2-9 Measurement Results for Which Output is Possible (3D Search)

The following values can be output using processing items related to result output. It is also possible to reference measurement values from calculation expressions and other processing units.

Measurement items	Character string	Description
Judge	JG	Judgment result 0: No judgment (unmeasured) 1: Judgment result OK -1: Judgment result NG -10: Error (image format mismatch) -11: Error (unregistered model) -12: Error (insufficient memory) -20: Error (other errors)
Count	C	No. of models detected If none detected, 0
Mean correlation	CR	Mean correlation
Surface correlation	CRN	Surface correlation
Contour correlation	CRG	Contour correlation
Object ID	OID	Object ID
Position X	TX	Position X
Position Y	TY	Position Y
Position Z	TZ	Position Z
Posture RX	RX	Posture RX

Measurement items	Character string	Description
Posture RY	RY	Posture RY
Posture RZ	RZ	Posture RZ
Posture type	RT	0: ZYX Euler angle, 1: ZYZ Euler angle, 2: XYZ Euler angle
RotMatrix11	RM11	RotMatrix11
RotMatrix12	RM12	RotMatrix12
RotMatrix13	RM13	RotMatrix13
RotMatrix21	RM21	RotMatrix21
RotMatrix22	RM22	RotMatrix22
RotMatrix23	RM23	RotMatrix23
RotMatrix31	RM31	RotMatrix31
RotMatrix32	RM32	RotMatrix32
RotMatrix33	RM33	RotMatrix33
CoG X	GX	Center of gravity X of the detected target
CoG Y	GY	Center of gravity Y of the detected target
CoG Z	GZ	Center of gravity Z of the detected target

2-2-10 External Reference Tables (3D Search)

No.	Data name	Data ident	Set/Get	Data range
0	Judge	judge	Get only	0: No judgment (unmeasured), 1: Judgment result OK, -1: Judgment result NG, -10: Error (image format mismatch), -11: Error (unregistered model), -12: Error (insufficient memory), -20: Error (other errors)
6	Detected count	detectedCount	Get only	0 to 128
7	Mean correlation	correlation	Get only	0 to 100
8	Surface correlation	correlationNorm	Get only	0 to 100
9	Contour correlation	correlationGrad	Get only	0 to 100
10	Object ID	detectedObjectId	Get only	-1 to 2,147,483,647
11	Position X	detectedTX	Get only	-10,000.0000 to 10,000.0000 [mm]
12	Position Y	detectedTY	Get only	-10,000.0000 to 10,000.0000 [mm]
13	Position Z	detectedTZ	Get only	-10,000.0000 to 10,000.0000 [mm]
14	Posture RX	detectedRX	Get only	-180.0000 to 180.0000 [deg]
15	Posture RY	detectedRY	Get only	-180.0000 to 180.0000 [deg]
16	Posture RZ	detectedRZ	Get only	-180.0000 to 180.0000 [deg]
17	Posture type	detectedRotType	Get only	0: ZYX Euler angle, 1: ZYZ Euler angle, 2: XYZ Euler angle
18	RotMatrix11	detectedRotMat11	Get only	-1.0000 to 1.0000
19	RotMatrix12	detectedRotMat12	Get only	-1.0000 to 1.0000
20	RotMatrix13	detectedRotMat13	Get only	-1.0000 to 1.0000

No.	Data name	Data ident	Set/Get	Data range
21	RotMatrix21	detectedRotMat21	Get only	-1.0000 to 1.0000
22	RotMatrix22	detectedRotMat22	Get only	-1.0000 to 1.0000
23	RotMatrix23	detectedRotMat23	Get only	-1.0000 to 1.0000
24	RotMatrix31	detectedRotMat31	Get only	-1.0000 to 1.0000
25	RotMatrix32	detectedRotMat32	Get only	-1.0000 to 1.0000
26	RotMatrix33	detectedRotMat33	Get only	-1.0000 to 1.0000
27	CoG X	detectedCogX	Get only	-10,000.0000 to 10,000.0000 [mm]
28	CoG Y	detectedCogY	Get only	-10,000.0000 to 10,000.0000 [mm]
29	CoG Z	detectedCogZ	Get only	-10,000.0000 to 10,000.0000 [mm]
101	Ref unit number of 3D Imaging unit	inGrpInput	Set/Get	-1 to 9,999
108	Display image kind	imageDispKind	Set/Get	0: Input - Measure image 0, 1: Camera - Depth image, 2: Camera - Captured(2D), 3: Camera - Captured(3D)
109	Ref scene number of 3D data manager unit	data3dSceneNo	Set/Get	-1 to 1,023
110	Ref unit number of 3D data manager unit	data3dUnitNo	Set/Get	-1 to 9,999
111	Index of CAD data	cadModelNo	Set/Get	0 to 99
113	Ref. posture RX	registInitPoseRX	Set/Get	-180.0000 to 180.0000 [deg]
114	Ref. posture RY	registInitPoseRY	Set/Get	-180.0000 to 180.0000 [deg]
115	Ref. posture RZ	registInitPoseRZ	Set/Get	-180.0000 to 180.0000 [deg]
119	Upper limit of latitude range (register)	upperRegistRange-Lat	Set/Get	-90 to 90 [deg]
120	Lower limit of latitude range (register)	lowerRegistRange-Lat	Set/Get	-90 to 90 [deg]
121	Upper limit of longitude range (register)	upperRegistRange-Lon	Set/Get	-90 to 90 [deg]
122	Lower limit of longitude range (register)	lowerRegistRange-Lon	Set/Get	-90 to 90 [deg]
123	Upper limit of distance range (register)	upperRegistRangeD-ist	Set/Get	50 to 5,000 [mm]
124	Lower limit of distance range (register)	lowerRegistRangeD-ist	Set/Get	50 to 5,000 [mm]
125	CAD model type	cadModelType	Set/Get	0: Solid, 1: Surface
126	Having front and back symmetry about current view	registHalfSide	Set/Get	0: Disable, 1: Enable
131	Enable masking	maskEnabled	Set/Get	0: Disable, 1: Enable
132	Ref scene number of masking image unit	maskSceneNo	Set/Get	-1 to 1,023

No.	Data name	Data ident	Set/Get	Data range
133	Ref unit number of masking image unit	maskUnitNo	Set/Get	-1 to 9,999
135	Mask image number	maskImageNo	Set/Get	0 to 31
136	Mask region color	maskColor	Set/Get	0: Black, 1: White, 2: Red, 3: Green, 4: Blue
138	Max. number of detection	maxDetectNum	Set/Get	1 to 128
140	Candidate Lv. (surface)	candidateLevelNorm	Set/Get	1 to 99
141	Candidate Lv. (contour)	candidateLevelGrad	Set/Get	1 to 99
142	Upper limit of latitude range (search)	upperMeasRangeLat	Set/Get	-90 to 90 [deg]
143	Lower limit of latitude range (search)	lowerMeasRangeLat	Set/Get	-90 to 90 [deg]
144	Upper limit of longitude range (search)	upperMeasRangeLon	Set/Get	-90 to 90 [deg]
145	Lower limit of longitude range (search)	lowerMeasRangeLon	Set/Get	-90 to 90 [deg]
146	Upper limit of roll range (search)	upperMeasRangeRoll	Set/Get	-180 to 180 [deg]
147	Lower limit of roll range (search)	lowerMeasRangeRoll	Set/Get	-180 to 180 [deg]
148	Upper limit of distance range (search)	upperMeasRangeDist	Set/Get	50 to 5,000 [mm]
149	Lower limit of distance range (search)	lowerMeasRangeDist	Set/Get	50 to 5,000 [mm]
150	Edge level (depth)	edgeLevelDepth	Set/Get	1.0000 to 1,000.0000
151	Edge level (image)	edgeLevelImage	Set/Get	1 to 1,000
153	Auto edge level (depth)	edgeLevelAutoDepth	Set/Get	0: Disable, 1: Enable
154	Auto edge level (image)	edgeLevelAutoImage	Set/Get	0: Disable, 1: Enable
156	Use image in rough-search	useImageGrad	Set/Get	0: Disable, 1: Enable
158	Sort type	sort	Set/Get	0: Mean correl. (Desc), 1: Mean correl. (Asc), 2: Surface correl. (Desc), 3: Surface correl. (Asc), 4: Contour correl. (Desc), 5: Contour correl. (Asc), 6: Position X (Desc), 7: Position X (Asc), 8: Position Y (Desc), 9: Position Y (Asc), 10: Position Z (Desc), 11: Position Z (Asc)
159	Result index focused	focusResult	Set/Get	0 to 127
162	Display feature	dispFeatureImage	Set/Get	0: Disable, 1: Enable
165	Upper limit of detected count	upperCount	Set/Get	0 to 128
166	Lower limit of detected count	lowerCount	Set/Get	0 to 128

No.	Data name	Data ident	Set/Get	Data range
167	Upper limit of mean correlation	upperCorrelation	Set/Get	0.0000 to 100.0000
168	Lower limit of mean correlation	lowerCorrelation	Set/Get	0.0000 to 100.0000
169	Upper limit of surface correlation	upperCorrelation-Norm	Set/Get	0.0000 to 100.0000
170	Lower limit of surface correlation	lowerCorrelation-Norm	Set/Get	0.0000 to 100.0000
171	Upper limit of contour correlation	upperCorrelation-Grad	Set/Get	0.0000 to 100.0000
172	Lower limit of contour correlation	lowerCorrelation-Grad	Set/Get	0.0000 to 100.0000
173	Upper limit of position X	upperTX	Set/Get	-10,000.0000 to 10,000.0000 [mm]
174	Lower limit of position X	lowerTX	Set/Get	-10,000.0000 to 10,000.0000 [mm]
175	Upper limit of position Y	upperTY	Set/Get	-10,000.0000 to 10,000.0000 [mm]
176	Lower limit of position Y	lowerTY	Set/Get	-10,000.0000 to 10,000.0000 [mm]
177	Upper limit of position Z	upperTZ	Set/Get	-10,000.0000 to 10,000.0000 [mm]
178	Lower limit of position Z	lowerTZ	Set/Get	-10,000.0000 to 10,000.0000 [mm]
179	Upper limit of posture RX	upperRX	Set/Get	-180.0000 to 180.0000 [deg]
180	Lower limit of posture RX	lowerRX	Set/Get	-180.0000 to 180.0000 [deg]
181	Upper limit of posture RY	upperRY	Set/Get	-180.0000 to 180.0000 [deg]
182	Lower limit of posture RY	lowerRY	Set/Get	-180.0000 to 180.0000 [deg]
183	Upper limit of posture RZ	upperRZ	Set/Get	-180.0000 to 180.0000 [deg]
184	Lower limit of posture RZ	lowerRZ	Set/Get	-180.0000 to 180.0000 [deg]
185	Reflect to overall judgement	overallJudge	Set/Get	0: ON, 1: OFF
1011	Name of CAD data	cadDataNameReg	Get only	Registered Model
5000	Register model	modelRegist	Get only	0: Register, 1: Unregister
5001	Train model	modelTrain	Get only	0: Register, 1: Unregister
5002	Search	autoMeasure	Set only	1: Execute
100026	Figure0 update figure	figArea0_update	Set only	1: Update
100500+N (N=0 to 127)	Mean correlation 0 : Mean correlation 127	resultsCorrel0 : resultsCorrel127	Get only	0.0000 to 100.0000

No.	Data name	Data ident	Set/Get	Data range
102500+N (N=0 to 127)	Surface correlation 0 : Surface correlation 127	resultsCorrelNorm : resultsCorrel- Norm127	Get only	0.0000 to 100.0000
104500+N (N=0 to 127)	Contour correlation 0 : Contour correlation 127	resultsCorrelGrad : resultsCorrel- Grad127	Get only	-180.0000 to 180.0000
106500+N (N=0 to 127)	Object ID 0 : Object ID 127	resultObjectId : resultObjectId127	Get only	-1 to 2,147,483,647
108500+N (N=0 to 127)	Position X 0 : Position X 127	resultDetectTX : resultDetectTX127	Get only	-10,000.0000 to 10,000.0000 [mm]
110500+N (N=0 to 127)	Position Y 0 : Position Y 127	resultDetectTY : resultDetectTY127	Get only	-10,000.0000 to 10,000.0000 [mm]
112500+N (N=0 to 127)	Position Z 0 : Position Z 127	resultDetectTZ : resultDetectTZ127	Get only	-10,000.0000 to 10,000.0000 [mm]
114500+N (N=0 to 127)	Posture RX 0 : Posture RX 127	resultDetectRX : resultDetectRX127	Get only	-180.0000 to 180.0000 [deg]
116500+N (N=0 to 127)	Posture RY 0 : Posture RY 127	resultDetectRY : resultDetectRY127	Get only	-180.0000 to 180.0000 [deg]
118500+N (N=0 to 127)	Posture RZ 0 : Posture RZ 127	resultDetectRZ : resultDetectRZ127	Get only	-180.0000 to 180.0000 [deg]
120500+N (N=0 to 127)	RotMatrix11 0 : RotMatrix11 127	resultDetectRotMa- tAA : resultDetectRotMa- tAA127	Get only	-1.0000 to 1.0000
122500+N (N=0 to 127)	RotMatrix12 0 : RotMatrix12 127	resultDetectRotMa- tAB : resultDetectRotMa- tAB127	Get only	-1.0000 to 1.0000
124500+N (N=0 to 127)	RotMatrix13 0 : RotMatrix13 127	resultDetectRotMa- tAC : resultDetectRotMa- tAC127	Get only	-1.0000 to 1.0000
126500+N (N=0 to 127)	RotMatrix21 0 : RotMatrix21 127	resultDetectRotMat- BA : resultDetectRotMat- BA127	Get only	-1.0000 to 1.0000

No.	Data name	Data ident	Set/Get	Data range
128500+N (N=0 to 127)	RotMatrix22 0 : RotMatrix22 127	resultDetectRot- MatBB : resultDetectRot- MatBB127	Get only	-1.0000 to 1.0000
130500+N (N=0 to 127)	RotMatrix23 0 : RotMatrix23 127	resultDetectRot- MatBC : resultDetectRot- MatBC127	Get only	-1.0000 to 1.0000
132500+N (N=0 to 127)	RotMatrix31 0 : RotMatrix31 127	resultDetectRotMat- CA : resultDetectRotMat- CA127	Get only	-1.0000 to 1.0000
134500+N (N=0 to 127)	RotMatrix32 0 : RotMatrix32 127	resultDetectRot- MatCB : resultDetectRot- MatCB127	Get only	-1.0000 to 1.0000
136500+N (N=0 to 127)	RotMatrix33 0 : RotMatrix33 127	resultDetectRot- MatCC : resultDetectRot- MatCC127	Get only	-1.0000 to 1.0000
138500+N (N=0 to 127)	CoG X 0 : CoG X 127	resultDetectCogX : resultDetect- CogX127	Get only	-10,000.0000 to 10,000.0000 [mm]
140500+N (N=0 to 127)	CoG Y 0 : CoG Y 127	resultDetectCogY : resultDetectCo- gY127	Get only	-10,000.0000 to 10,000.0000 [mm]
142500+N (N=0 to 127)	CoG Z 0 : CoG Z 127	resultDetectCogZ : resultDetectCogZ127	Get only	-10,000.0000 to 10,000.0000 [mm]

2-3 Container Detection

This is a processing item specific to the FH series 3D robot vision system.

This processing item defines a 3D container model for detecting collision of the hand model in the **Grasp Planning** processing item.

This processing item requires the calibration result data of the **HandEye Calibration** processing item.

This processing item aligns the container model by using the information in the depth map and raw image (2D) measured in the **Camera Image Input AOS** processing item.

Display part of the floor or a surface parallel with and at a different height from the floor, and then perform simultaneously the 3D imaging and 2D imaging in the **Camera Image Input AOS** processing item. Detect and register the floor where the container sits by using the information in the depth map obtained from the 3D imaging. Then, with the shape search model that was generated based on the actual dimensions of the container, search the raw image (2D) obtained from the 2D imaging two-dimensionally to detect the position/posture of the container on the floor.

It also generates a mask image to limit the search region to the inside of the container in the **3D Search** processing item. (Refer to *2-2-4 Region settings (3D Search)* on page 2-14.)

3D container model

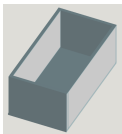

Container position/posture detection



Mask image to limit the search region



Used in the Following Case

When limiting the search range to the area inside the container in the **3D Search** processing item.
When calculating the pose of grasping in the **Grasp Planning** processing item, taking into account the collisions between the robot hand and the container.

Example: Position detection for bulk picking of parts in a container

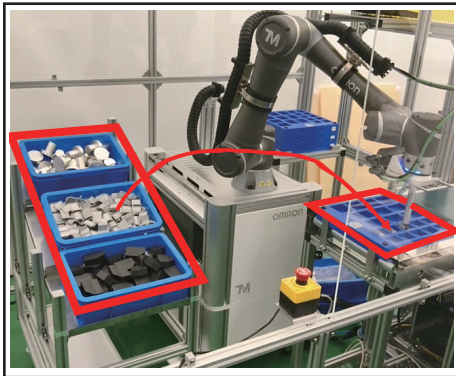

Detecting a container and floor, and passing the information to the Grasp Planning processing item in the measurement flow enables the calculation of a safe grasp point where the robot hand does not collide with the container and floor.



Precautions for Correct Use

- In this processing item, it is necessary to capture 3D images for floor settings. It is also necessary to capture 2D images for container detection.
- This processing item references the results of the **HandEye Calibration** processing item. Confirm that the referenced processing items are set correctly.
- Correct measurement is not possible with images that have undergone a coordinate transformation such as Position Compensation or Polar Transformation.

2-3-1 Settings Flow (Container Detection)

To set Container Detection, follow the steps below.

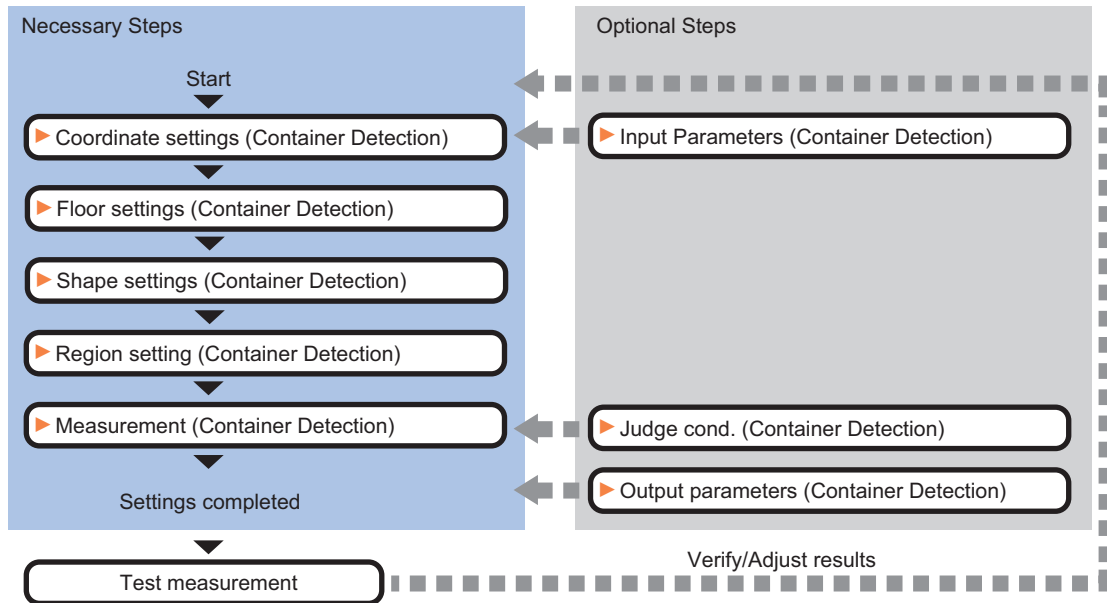

List of Container Detection Items

Item	Description
Input parameters	Check the input parameters. <i>2-3-2 Input parameters (Container Detection) on page 2-47</i>
Coordinate settings	Set the reference coordinate system for the container and floor. <i>2-3-3 Coordinate settings (Container Detection) on page 2-48</i>
Floor settings	Specify a region of the floor based on information in the input depth map and register the floor. Make sure that part of the floor or a surface parallel with and at a different height from the floor is displayed when you perform this task. <i>2-3-4 Floor settings (Container Detection) on page 2-52</i>
Shape settings	It is difficult to set the container shape from the 3D measurement results. Therefore, set the container shape based on the actual dimensions of the container. <i>2-3-5 Shape settings (Container Detection) on page 2-56</i>
Region setting	Set the region in which to search for the container. <i>2-3-6 Region setting (Container Detection) on page 2-62</i>
Measurement	Set the measurement conditions for detecting the container as measurement parameters. <i>2-3-7 Measurement (Container Detection) on page 2-63</i>
Judge cond.	Set the judgment conditions for the measurement results. <i>2-3-8 Judge cond. (Container Detection) on page 2-67</i>
Output parameters	Select how to handle the coordinates to be output to the external device as measurement results. This item can be changed as necessary. Normally, the factory default value will be used. <i>2-3-9 Output Parameters (Container Detection) on page 2-71</i>

2-3-2 Input parameters (Container Detection)

Check the input parameters.

- 1 In the Item tab area, click the **Input parameter** tab.
Check that **Input depth map settings** is set to *Measure image 1* and **Input image settings** is set to *Measure image 0*.

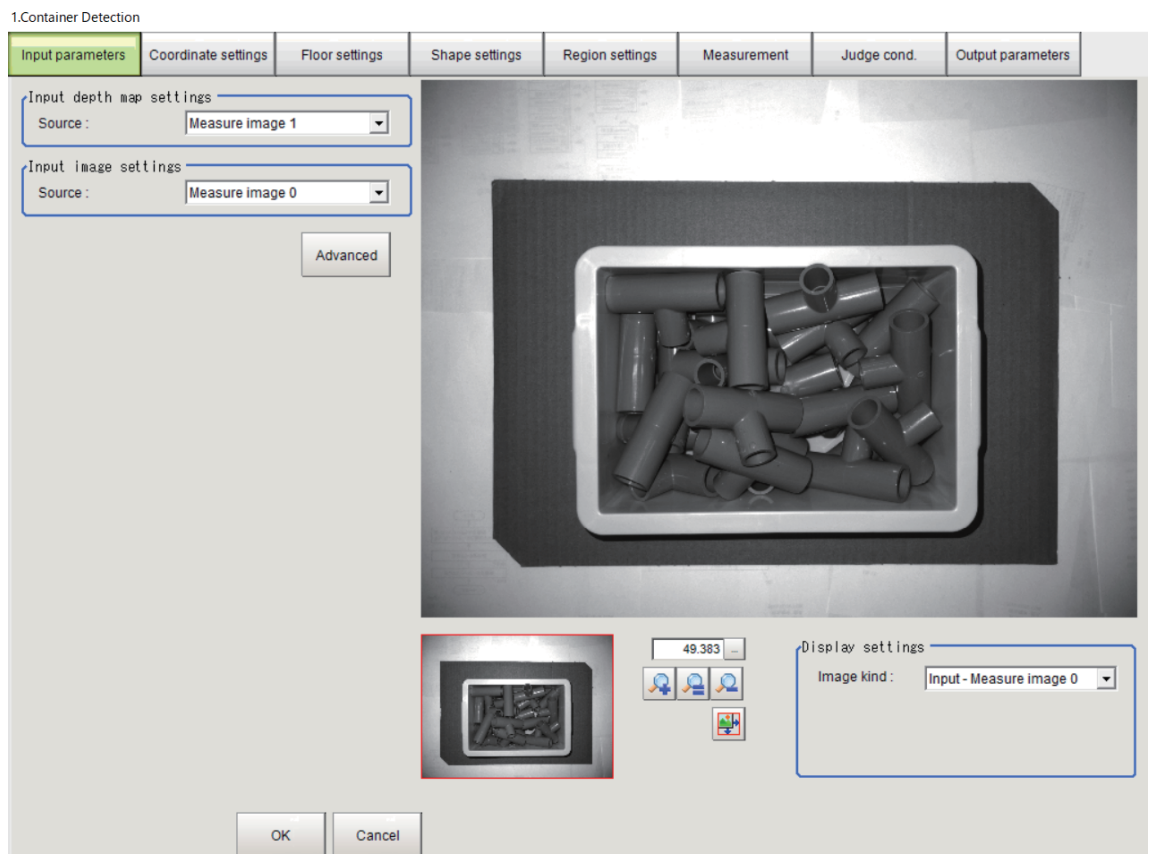

- 2 Click **Advanced**.
In the **3D Imaging unit settings** area, check that the **Camera Image Input AOS** processing item to reference is set.
If they are not set, review the flow and check again.

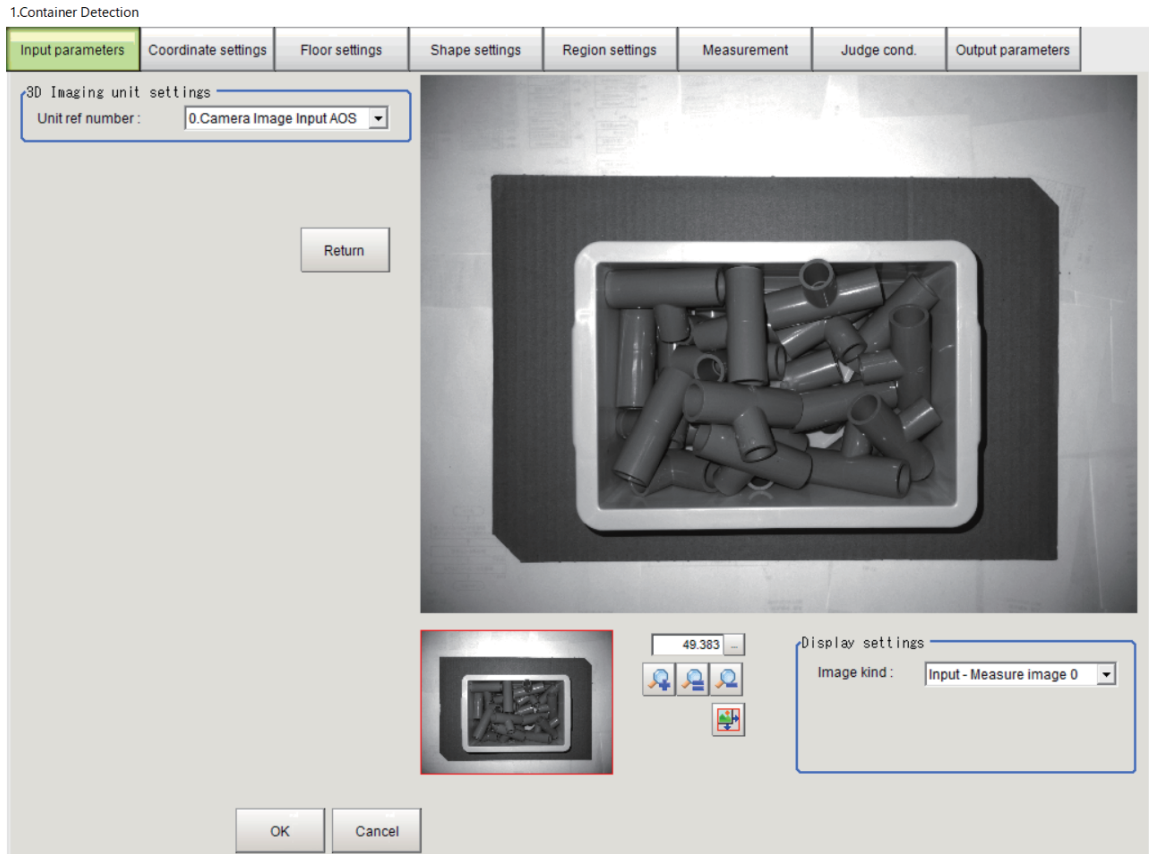

3 Click **Return** to return to the previous menu.

4 In the **Display settings** area, you can change the image to display.

Setting item	Setting value [Factory default]	Description
Image kind	<ul style="list-style-type: none"> [Input - Measure image 0] Camera - Depth image Camera - Captured (2D) Camera - Captured (3D) 	<p>Select the image to display in the Image display area.</p> <ul style="list-style-type: none"> Input - Measure image 0: The input image is displayed. If there are no processing items such as filters, Measurement image 0 from the Camera Image Input AOS processing item is displayed. Camera - Depth image: The distance image from the Camera Image Input AOS processing item is displayed. Camera - Captured (2D): The raw image (2D) from the Camera Image Input AOS processing item is displayed. If the 2D imaging settings are not enabled, the displayed image is completely black. Camera - Captured (3D): The raw image (3D) from the Camera Image Input AOS processing item is displayed. If the 3D imaging settings are not enabled, the displayed image is completely black.

2-3-3 Coordinate settings (Container Detection)

Set the reference coordinate system for the container and floor.

1 In the Item tab area, click the **Coordinate settings** tab.

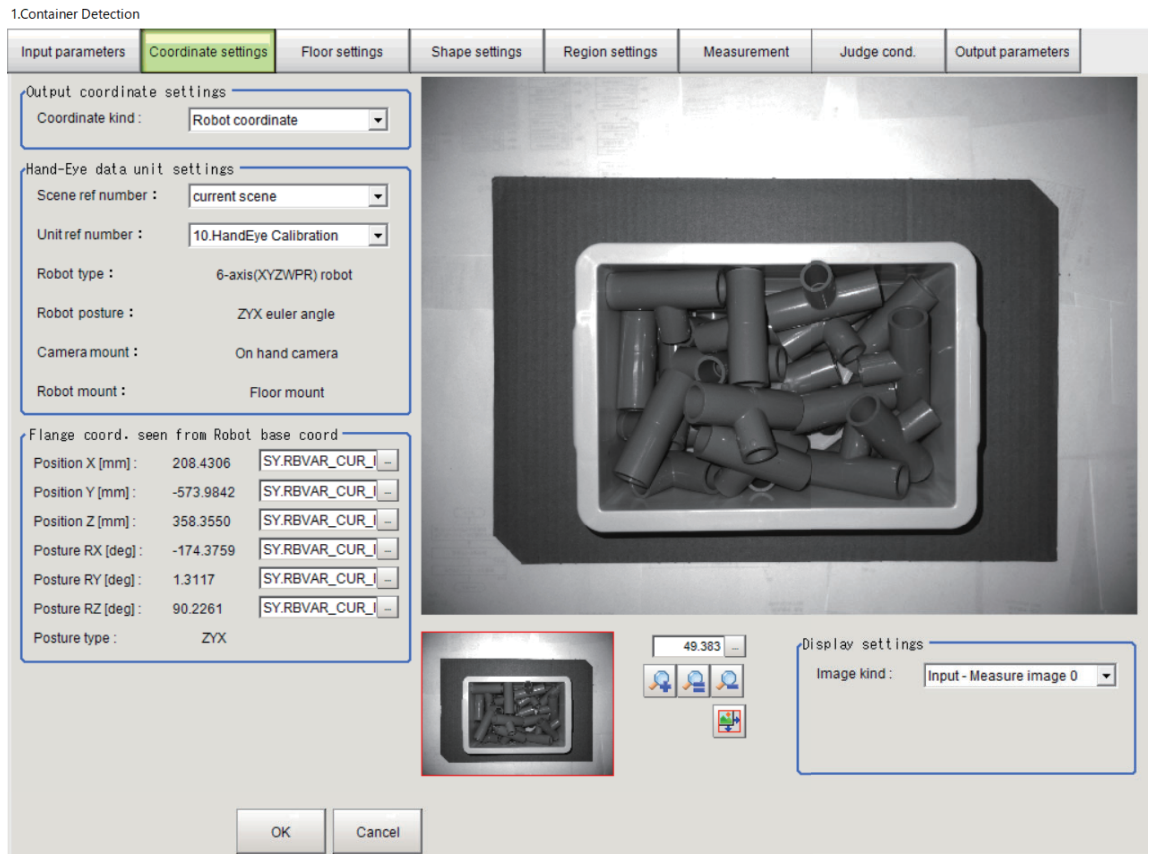

- 2** Set the **Coordinate kind** in the **Output coordinate settings** area. Select *Robot coordinate*.
- 3** In the **Hand-Eye data unit settings** area, select the **HandEye Calibration** processing item to reference.
Information on the selected processing unit is displayed in the **Hand-Eye data unit settings** area. The displayed information depends on the settings for the referenced **HandEye Calibration**.

Output coordinate settings	
Coordinate kind :	Robot coordinate
Hand-Eye data unit settings	
Scene ref number :	current scene
Unitref number :	10.Box type container
Robot type :	6-axis(XYZWPR) robot
Robot posture :	ZYX Euler angle
Camera mount :	On hand camera
Robot mount :	Floor mount
Flange coord. seen from Robot base coord	
Position X [mm] :	208.4306 SY.RBVAR_CUR_I
Position Y [mm] :	-573.9842 SY.RBVAR_CUR_I
Position Z [mm] :	358.3550 SY.RBVAR_CUR_I
Posture RX [deg] :	-174.3759 SY.RBVAR_CUR_I
Posture RY [deg] :	1.3117 SY.RBVAR_CUR_I
Posture RZ [deg] :	90.2261 SY.RBVAR_CUR_I
Posture type :	ZYX

Setting item	Setting value [Factory default]	Description
Scene ref number	-1 to 127 [-1: current scene]	Sets the scene number in which the HandEye Calibration is registered.
Unit ref number	-	Sets the processing unit number for the HandEye Calibration .
Robot type	-	The setting of the referenced HandEye Calibration processing item is displayed.
Robot posture	-	
Camera mount	-	
Robot mount	-	



Precautions for Correct Use

If the coordinate settings are not completed, you cannot set the items in tabs that follow this tab.

- If the warning message *Hand-Eye data is not set.* is displayed, review the reference settings in the **Hand-Eye data unit settings** area.

- 4 If **Camera mount** is set to *On hand camera*, set the items in the **Robot flange coord. seen from robot base coord** area.

Setting item	Setting value [Factory default]	Description
Position X [mm]	-10,000.0000 to 10,000.0000 [0.0000]	Set the position/posture of the flange in the robot base coordinate system when the input image was captured. If you set Posture type to <i>XYZ Euler angle</i> , RX is replaced with RZ .
Position Y [mm]	-10,000.0000 to 10,000.0000 [0.0000]	
Position Z [mm]	-10,000.0000 to 10,000.0000 [0.0000]	
Posture RX [deg] / Posture RZ [deg]	-180.0000 to 180.0000 [0.0000]	
Posture RY [deg]	-180.0000 to 180.0000 [0.0000]	
Posture RZ [deg]	-180.0000 to 180.0000 [0.0000]	
Posture type	-	



Precautions for Correct Use

If the coordinate settings are not completed, you cannot set the items in tabs that follow this tab.

- If the warning message *Flange coord. is invalid.* is displayed, review the set values.
If the evaluation values are all 0 or out of the setting range in the expression for position or posture, a warning message is displayed.
- If there is no calibration result data because hand-eye calibration has not been performed, the warning message *Hand-Eye data is not set.* is displayed.

5 In the **Display settings** area, you can change the image to display.

Setting item	Setting value [Factory default]	Description
Image kind	<ul style="list-style-type: none"> • [Input - Measure image 0] • Camera - Depth image • Camera - Captured (2D) • Camera - Captured (3D) 	Select the image to display in the Image display area. <ul style="list-style-type: none"> • Input - Measure image 0: The input image is displayed. If there are no processing items such as filters, Measurement image 0 from the Camera Image Input AOS processing item is displayed. • Camera - Depth image: The distance image from the Camera Image Input AOS processing item is displayed. • Camera - Captured (2D): The raw image (2D) from the Camera Image Input AOS processing item is displayed. If the 2D imaging settings are not enabled, the displayed image is completely black. • Camera - Captured (3D): The raw image (3D) from the Camera Image Input AOS processing item is displayed. If the 3D imaging settings are not enabled, the displayed image is completely black.

2-3-4 Floor settings (Container Detection)

Specify a region of the floor based on information in the input depth map and register the floor. Make sure that part of the floor or a surface parallel with and at a different height from the floor is displayed when you perform this task.

By registering the floor, the system measures the distance and tilt to the floor and sets a virtual camera so that the distance between the top of the container and the 3D vision sensor is maintained. This enables the conversion of a raw image into the view seen from the virtual camera that directly faces the floor to produce a unified view.

Example:

Raw image (3D)

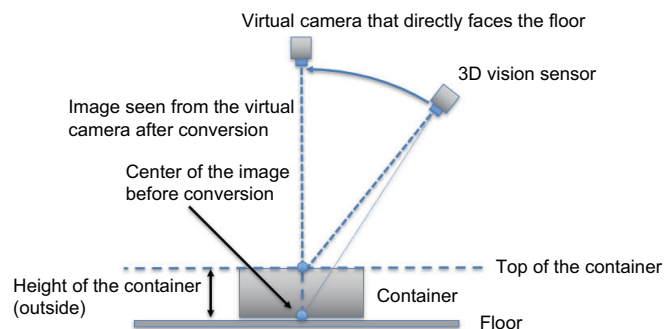
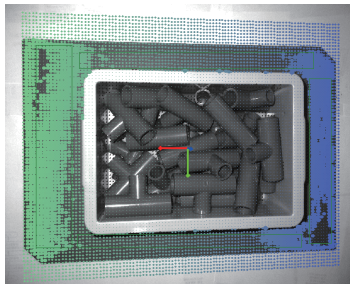

Raw image (2D) before conversion



Raw image (2D) after conversion



Setting the Floor (Floor Region)

This item is used to set up the measurement area.

Use a rectangle, wide line, ellipse (circle), wide circle, wide arc or polygon to specify a measurement region for **Floor settings**.



Additional Information

Up to 8 graphs can be used together to draw the measured region. Complex areas can be drawn through image integration or by removing unnecessary sections from the measurement region.

- 1 In the Item tab area, click the **Floor settings** tab.

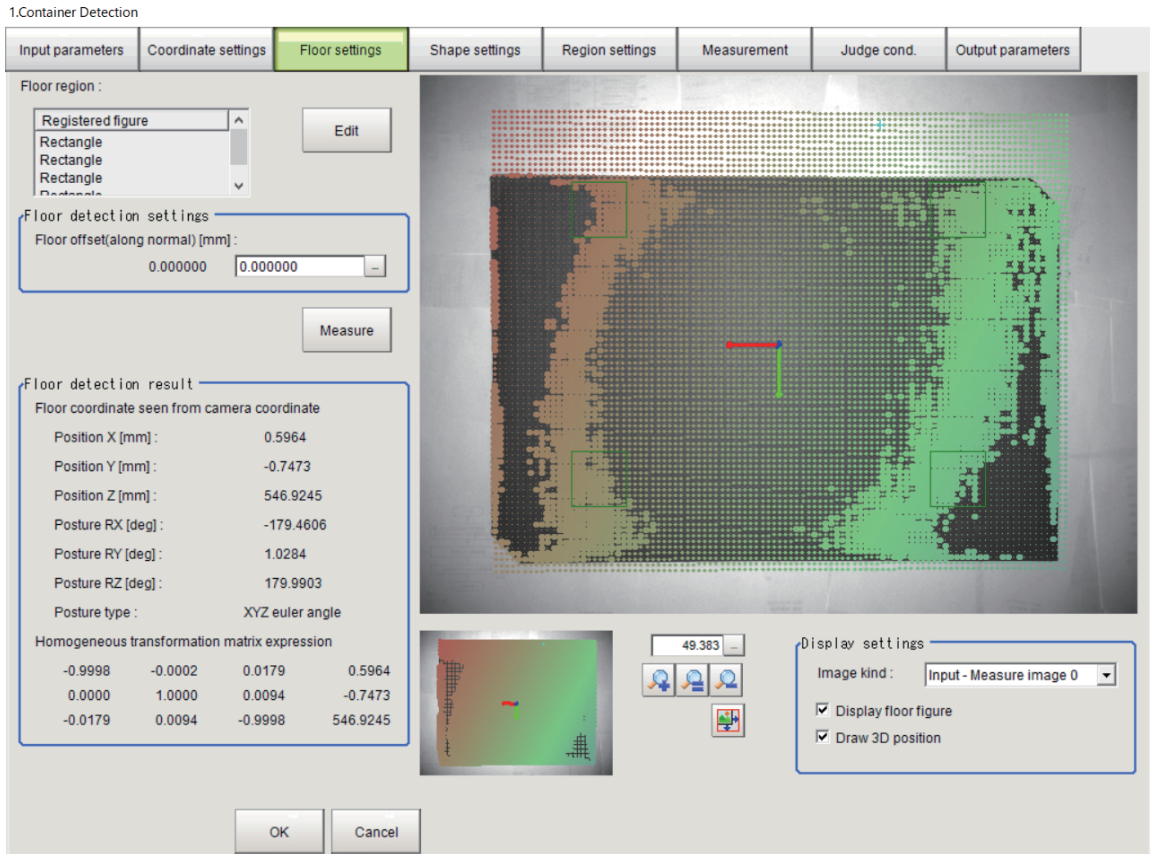

2 Click **Edit** in the **Floor** region.
The figure setting area is displayed.

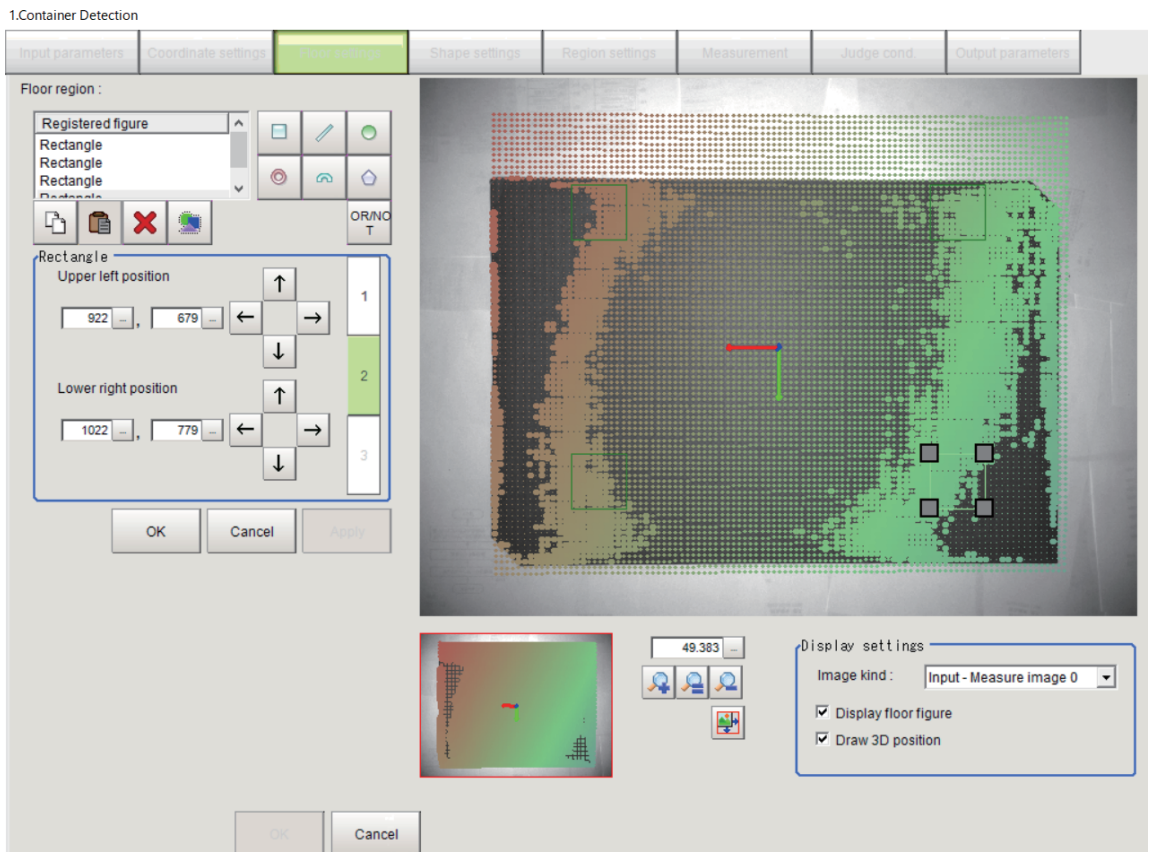

- 3 Use the drawing tools to set the measurement region.
Up to 8 figures can be combined.
- 4 Click **OK** in the figure setting area.
 - **OK**: Changes the settings and returns to the previous menu.
 - **Cancel**: Changes are discarded. Returns to the previous menu.
 - **Apply**: Updates the settings without leaving edit window.



Precautions for Correct Use

If the floor registration is not completed, you cannot set the items in tabs that follow this tab.

Detecting the Floor

- 1 In the Item tab area, click the **Floor settings** tab.

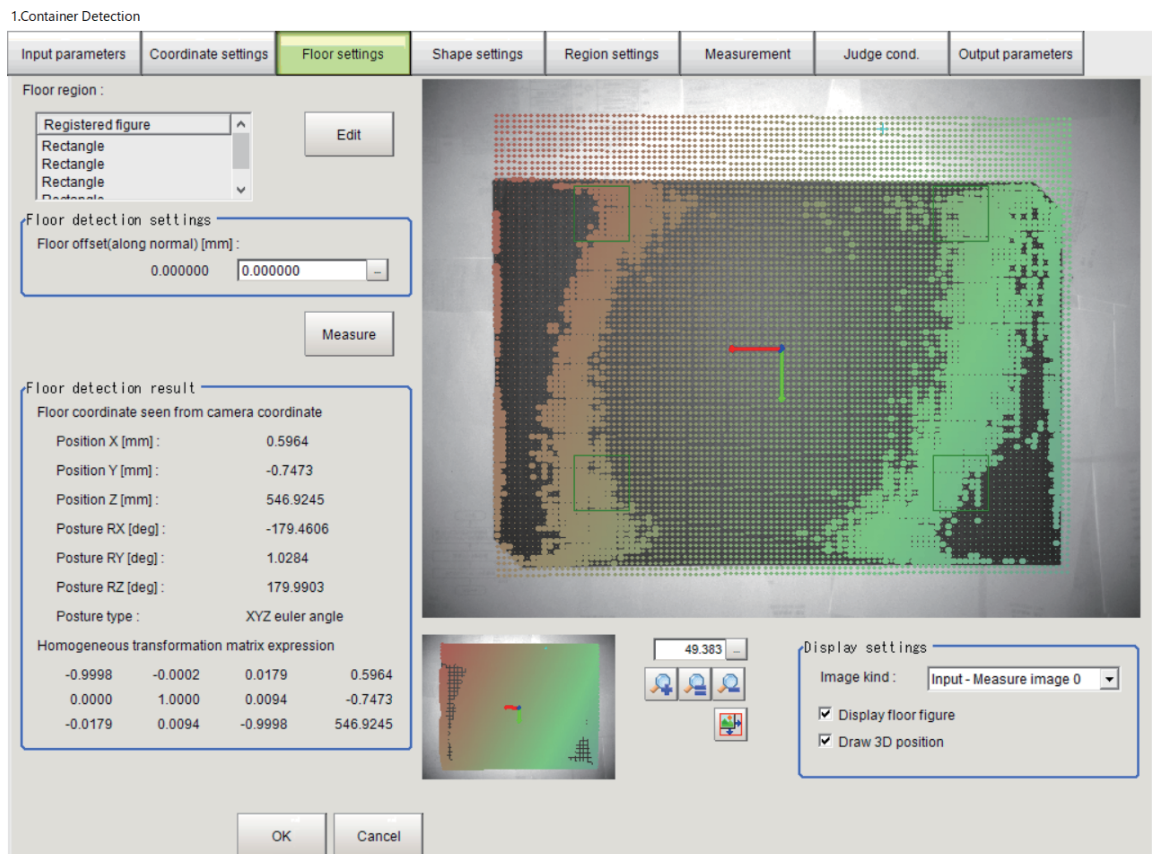

- 2 Set the value in the **Floor detection settings** area as required.

Setting item	Setting value [Factory default]	Description
Floor offset (along normal) [mm]	-10,000.0000 to 10,000.0000 [0.0000]	Use this setting when a surface parallel with and at a different height from the floor is displayed without the floor displayed. Measure the parallel surface and then set the signed offset between the surface and the floor.

- 3** Click **Measure**. When a warning message is displayed, confirm it and click **OK**.

Precaution

Current robot position and posture set in "Coordinate settings" tab is retained in subsequent measurement. If you need to refresh the retained value, re-measure floor and container position.

OK

If the floor detection is successful, the floor registration is completed. In this case, the floor figure is displayed at the center of the image, along with the coordinate axes of the floor coordinate system.

If the floor detection fails, a measurement failure error dialog is displayed.



Precautions for Correct Use

If the floor registration is not completed, you cannot set the items in tabs that follow this tab.

- 4** In the **Floor detection result** area, check the detection results.

Item	Description
Position X [mm]	The values of the floor coordinate system seen from the camera coordinate system are displayed.
Position Y [mm]	
Position Z [mm]	
Posture RX [deg]	
Posture RY [deg]	
Posture RZ [deg]	<i>XYZ Euler angle</i> is displayed as the posture angle type.
Posture type	
Homogeneous transformation matrix expression	The position and posture of the planar coordinate system seen from the floor are displayed in homogeneous transformation matrix expression.

Checking the Floor Status on the Image (Display Settings)

By changing the display settings, you can check the status of the floor detected on the image.

- 1** Set the value in the **Display settings** area.

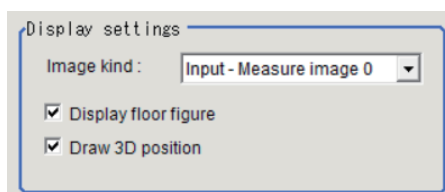

Setting item	Setting value [Factory default]	Description
Image kind	<ul style="list-style-type: none"> • [Input - Measure image 0] • Camera - Depth image • Camera - Captured (2D) • Camera - Captured (3D) 	<p>Select the image to display in the Image display area.</p> <ul style="list-style-type: none"> • Input - Measure image 0: The input image is displayed. If there are no processing items such as filters, Measurement image 0 from the Camera Image Input AOS processing item is displayed. • Camera - Depth image: The distance image from the Camera Image Input AOS processing item is displayed. • Camera - Captured (2D): The raw image (2D) from the Camera Image Input AOS processing item is displayed. If the 2D imaging settings are not enabled, the displayed image is completely black. • Camera - Captured (3D): The raw image (3D) from the Camera Image Input AOS processing item is displayed. If the 3D imaging settings are not enabled, the displayed image is completely black.
Display floor figure	<ul style="list-style-type: none"> • [Checked] • Unchecked 	<p>Check this to display the floor figure if the floor figure is detected. The coordinate axes (X axis: red, Y axis: green, Z axis: blue) that represent the floor coordinates seen from the camera coordinate system are displayed, along with the point figures drawn as an expression of 3D points projected on the image in the detected plane.</p> <p>The point figures are colored red, green, and blue from the front to back to indicate the distance ranges in the Z direction. If they are distributed at approximately the same distance, the entire floor is displayed in the same color.</p> <p>As for the size of the point figures, points that have an error of 1.0 [mm] or less with the point clouds measured in the Camera Image Input AOS are displayed larger. Points that have an error of more than 1.0 [mm] with the point clouds measured in the Camera Image Input AOS and are located on the front of them in the Z direction are displayed smaller. Points that are located on the back of the point clouds measured in the Camera Image Input AOS in the Z direction are displayed even smaller.</p> 
Draw 3D position	<ul style="list-style-type: none"> • [Checked] • Unchecked 	<p>Check this to display the measured 3D position (X, Y, Z) corresponding to the clicked pixel on the displayed image as an integer [mm]. You can display up to two points at the same time. If you click the third point, the first point disappears.</p> <p>If you right-click two points, the distance (L) between the two points and the relative position of the second point (X', Y', Z') seen from the first point are displayed as integers [mm].</p>

2 Check the status on the image and set the floor.

2-3-5 Shape settings (Container Detection)

It is difficult to set the container shape from the 3D measurement results. Therefore, set the container shape based on the actual dimensions of the container.

Setting the Container Shape

- 1 In the Item tab area, click the **Shape settings** tab.

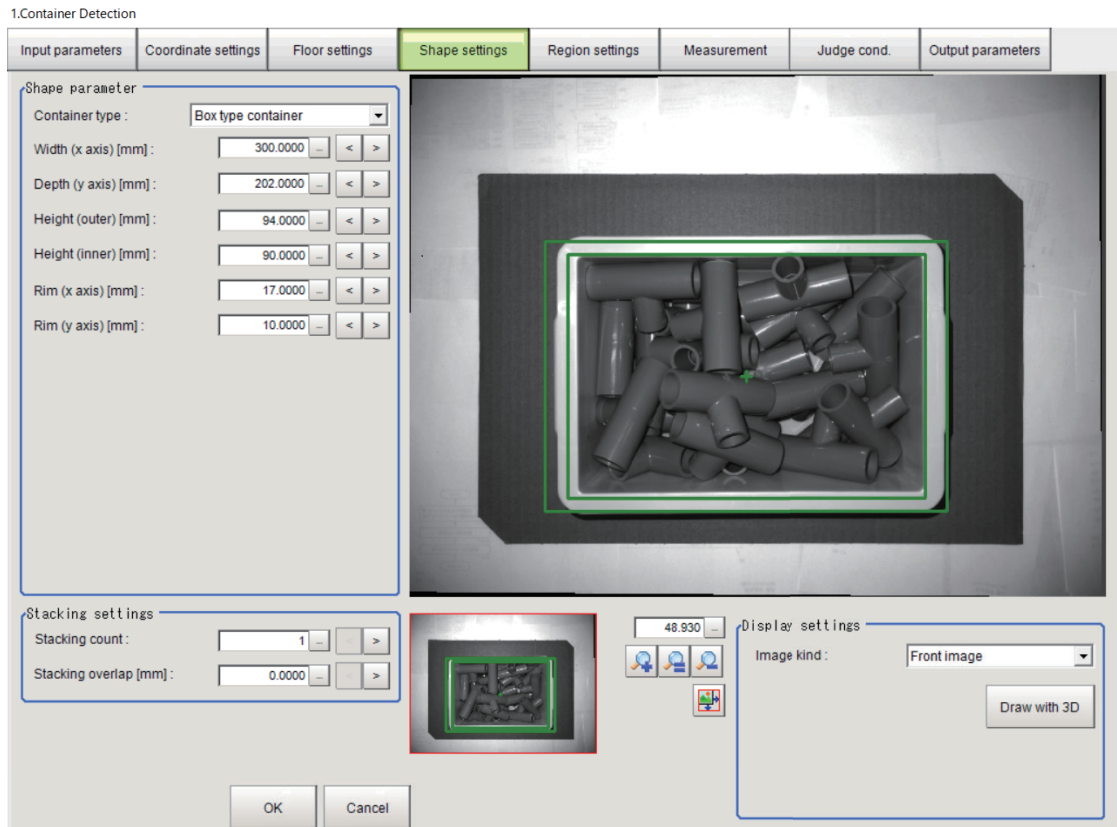

- 2 Set the value in the **Shape parameter** area.

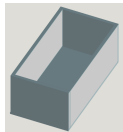
Setting item	Setting value [Factory default]	Description
Container type	[Box type container]	Set the container type. You can set only <i>Box type container</i> . <ul style="list-style-type: none"> Box type container: A cubic container with a single open face. The bottom and top of the container are parallel to the floor. Opposite walls are parallel to each other. 
Width (x axis) [mm]	10.0000 to 10,000.0000 [300.0000]	Set the outline width of the container (including both edges). The width direction is the X-axis direction of the camera coordinate system (the horizontal direction of the image).
Depth (y axis) [mm]	10.0000 to 10,000.0000 [200.0000]	Set the outline depth of the container (including both edges). The depth direction is the Y-axis direction of the camera coordinate system (the vertical direction of the image).
Height (outer) [mm]	10.0000 to 10,000.0000 [100.0000]	Set the outside height of the container.

Setting item	Setting value [Factory default]	Description
Height (inner) [mm]	10.0000 to 10,000.0000 [90.0000]	Set the inside height of the container.
Rim (x axis) [mm]	0.0000 to 1,000.0000 [10.0000]	Set the edge thickness of the container. The settings are the edge thickness in the X-axis direction of the camera coordinate system (the horizontal direction of the image) and the edge thickness in the Y-axis direction of the camera coordinate system (the vertical direction of the image).
Rim (y axis) [mm]	0.0000 to 1,000.0000 [10.0000]	



Precautions for Correct Use

- You cannot set a value that causes the outside height of the container to be equal to or greater than the vertical distance between the camera and the floor.
- If you set a value that causes the width or depth of the container to stick out of the field of view of the camera, the container detection fails.
- You cannot set a value that causes the internal space of the container to be less than 10 mm.
- Container detection may NG if the rim of the container is less than 10 mm.

3

Make the settings in the **Stacking settings** area.

Setting item	Setting value [Factory default]	Description
Stacking count	1 to 5 [1]	Set the number of stacked containers.
Stacking overlap [mm]	0.0000 to 9,999.9999 [0.0000]	Set the amount of overlap between stacked containers. You cannot set this to greater than the inside height of the container.



Precautions for Correct Use

- You cannot set a value that causes the outside height of the stacked containers to be equal to or greater than the vertical distance between the camera and the floor.

Checking the Container Shape Status on the Image (Display Settings)

By changing the display settings, you can check the status of the container shape set on the image. Changing the set value of the container shape also changes the displayed container shape.

- Front image

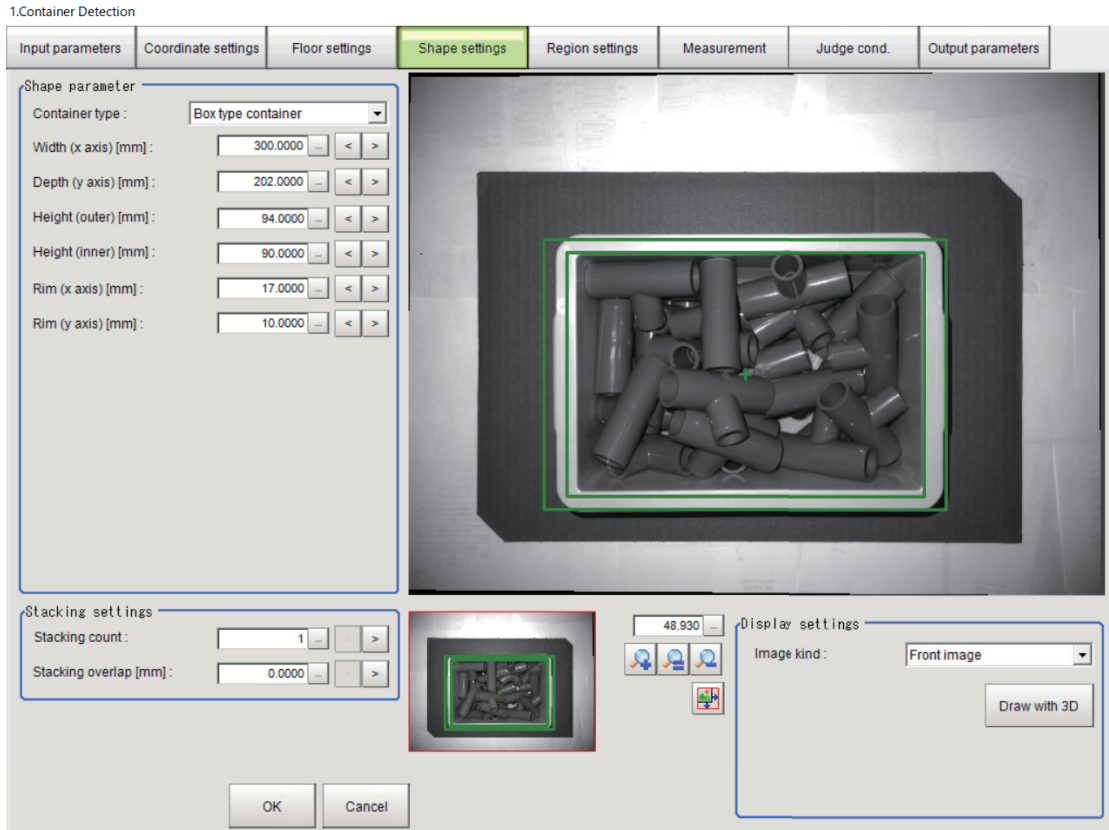

• Container image

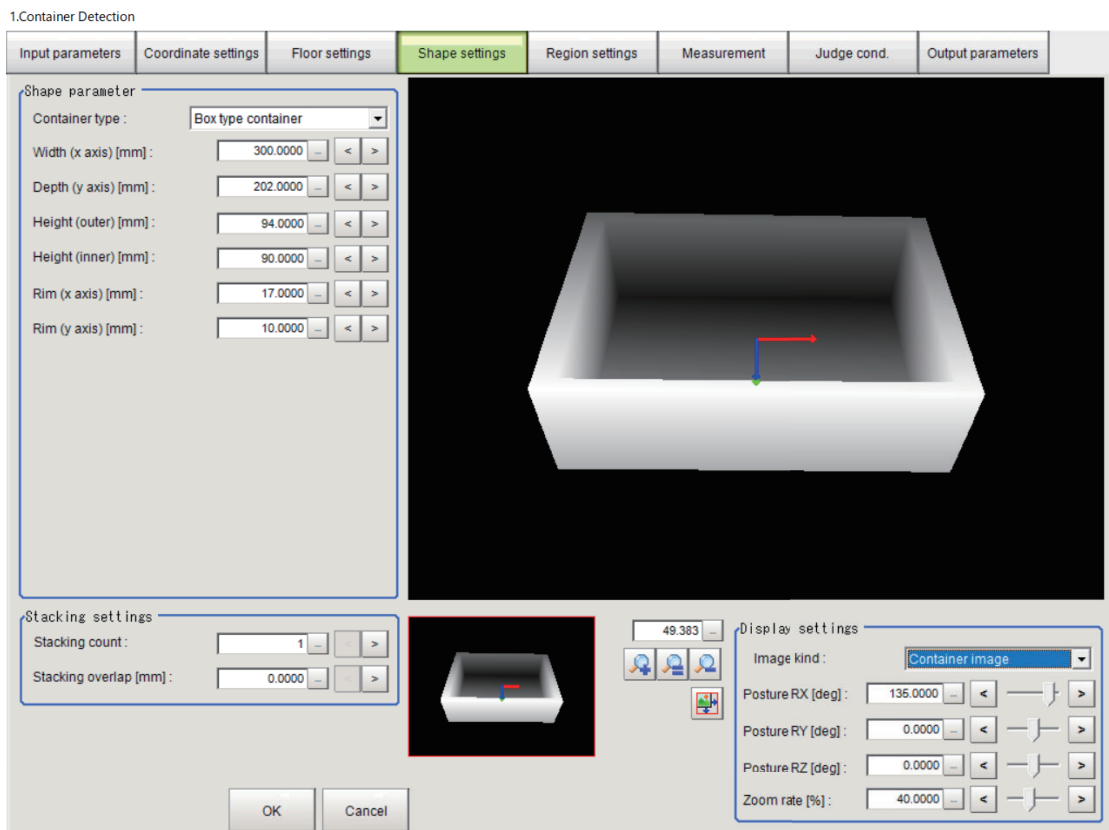

1 Set the value in the **Display settings** area.

Setting item	Setting value [Factory default]	Description
Image kind	<ul style="list-style-type: none"> [Front image] Container image 	<ul style="list-style-type: none"> Front image: The front image, which shows how the input image appears when it is seen from the top of the container, is displayed. The inner diameter and outer diameter of the container are displayed in green. You can change the position of the center point by clicking the image area. To rotate the displayed container shape, right-clicking and drag it. Container image: A CAD mesh data image of the container shape generated from the set parameters is displayed.
Draw with 3D	-	<p>This item is displayed only when <i>Front image</i> is selected in Image kind.</p> <p>Click this to start the 3D result display tool FZ-3DVisualizer. The 3D result display tool FZ-3DVisualizer displays a 3D model of the container built with the set parameters, together with a 3D display of the measurement point cloud.</p> <p><i>Checking 3D Measurement Results (FZ-3DVisualizer)</i> on page 2-60</p>
Posture RX [deg]	-180.0000 to 180.0000 [135.0000]	<p>This item is displayed only when <i>Container image</i> is selected in Image kind.</p> <p>Specify the posture of the displayed container as an XYZ Euler angle. Since this is the amount of rotation around each axis in XYZ Euler angle, the image does not rotate around the coordinate axes that you see now.</p>
Posture RY [deg]	-180.0000 to 180.0000 [0.0000]	
Posture RZ [deg]	-180.0000 to 180.0000 [0.0000]	
Zoom rate [%]	1.0000 to 100.0000 [40.0000]	<p>This item is displayed only when <i>Container image</i> is selected in Image kind.</p> <p>Set the zoom rate for the CAD mesh image of the displayed container shape.</p>

2 Check the status on the image and set the shape.

● Checking 3D Measurement Results (FZ-3DVisualizer)

FZ-3DVisualizer is a result display tool that draws 3D point clouds, recognized workpieces, recognized pose of grasping, etc. in 3D space. Use this tool to check the detection results for the **3D Search** and **Grasp Planning** processing items to see if objects are detected in appropriate positions in 3D space.

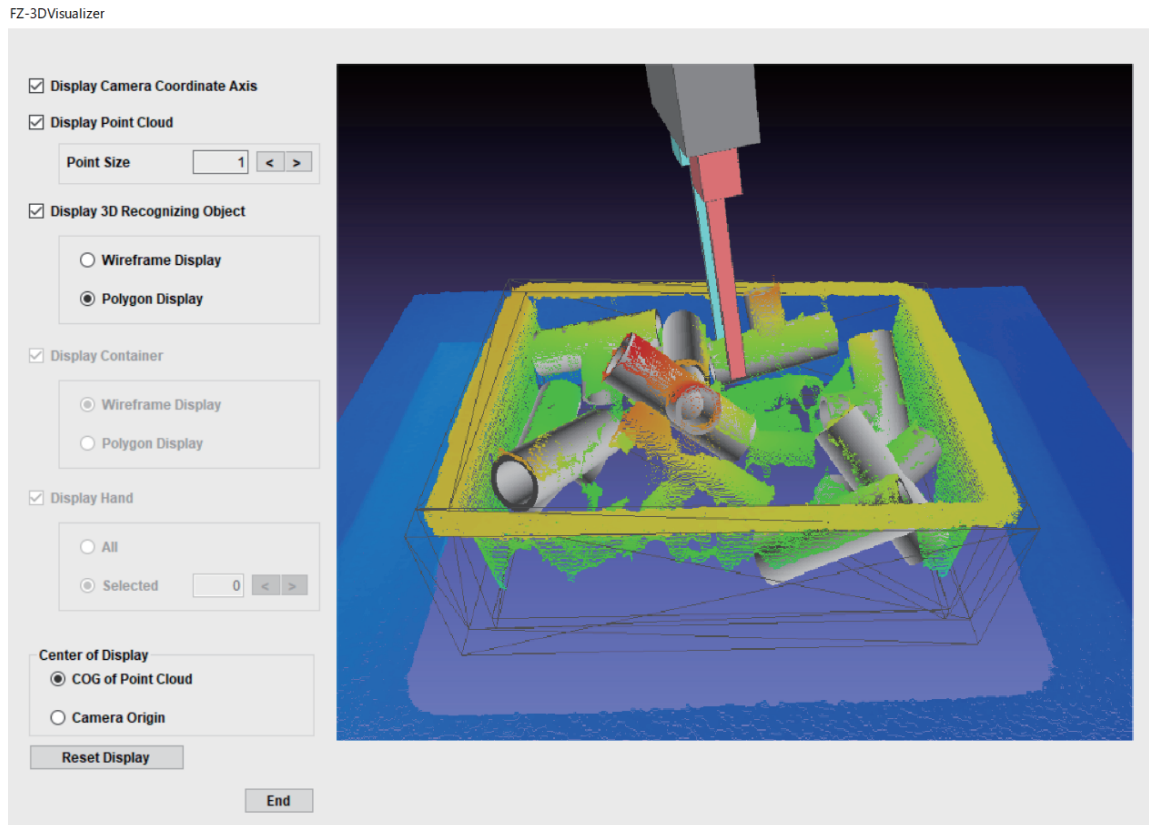

3D objects are displayed in the image display area.

Operation	Description
Left-click + Drag	You can move the viewpoint by rotating the image around the display center of the image display area.
Mouse wheel scroll	You can zoom in and out the image around the display center of the image display area.
Middle click + Drag or Shift key + Left-click + Drag	You can move the display center of the image display area.

Item	Description
Display Camera Coordinate Axis	Show or hide the camera coordinate axes.
Display Point Cloud	Show or hide the point cloud data.
Point Size	Change the size of the displayed point cloud. The point cloud size range is 1 to 5.
Display 3D Recognizing Object	Show or hide the workpiece recognized in the 3D Search processing item.
Wireframe Display	Set the workpiece display format to wireframe display.
Polygon Display	Set the workpiece display format to polygon display.
Display Container	Show or hide the container detected in the Container Detection processing item. It cannot be set in the 3D Search processing item.
Wireframe Display	Set the workpiece display format to wireframe display.
Polygon Display	Set the workpiece display format to polygon display.

Item	Description
Display Hand	Show or hide the pose of grasping calculated in the Grasp Planning processing item. It cannot be set in the 3D Search processing item.
All	All candidates are displayed at the same time.
Selected	One of the candidates for the specified measurement result number is displayed.
Center of Display	Switch the display center of the image display area between the center of gravity of the point cloud (center of gravity XYZ of the point cloud data) and the camera origin.
COG of Point Cloud	
Camera Origin	
Reset Display	Reset the display position of the image display area to the initial position.
End	Close the FZ-3DVisualizer tool.

2-3-6 Region setting (Container Detection)

Set the region in which to search for the container.

Instead of measuring the entire input image, narrowing the measurement area shortens the processing time.

Use a rectangle, ellipse (circle), wide circle, or polygon to specify a measurement region.



Additional Information

Up to 8 graphs can be used together to draw the measured region. Complex areas can be drawn through image integration or by removing unnecessary sections from the measurement region.

- 1 In the Item tab area, click the **Region settings** tab.

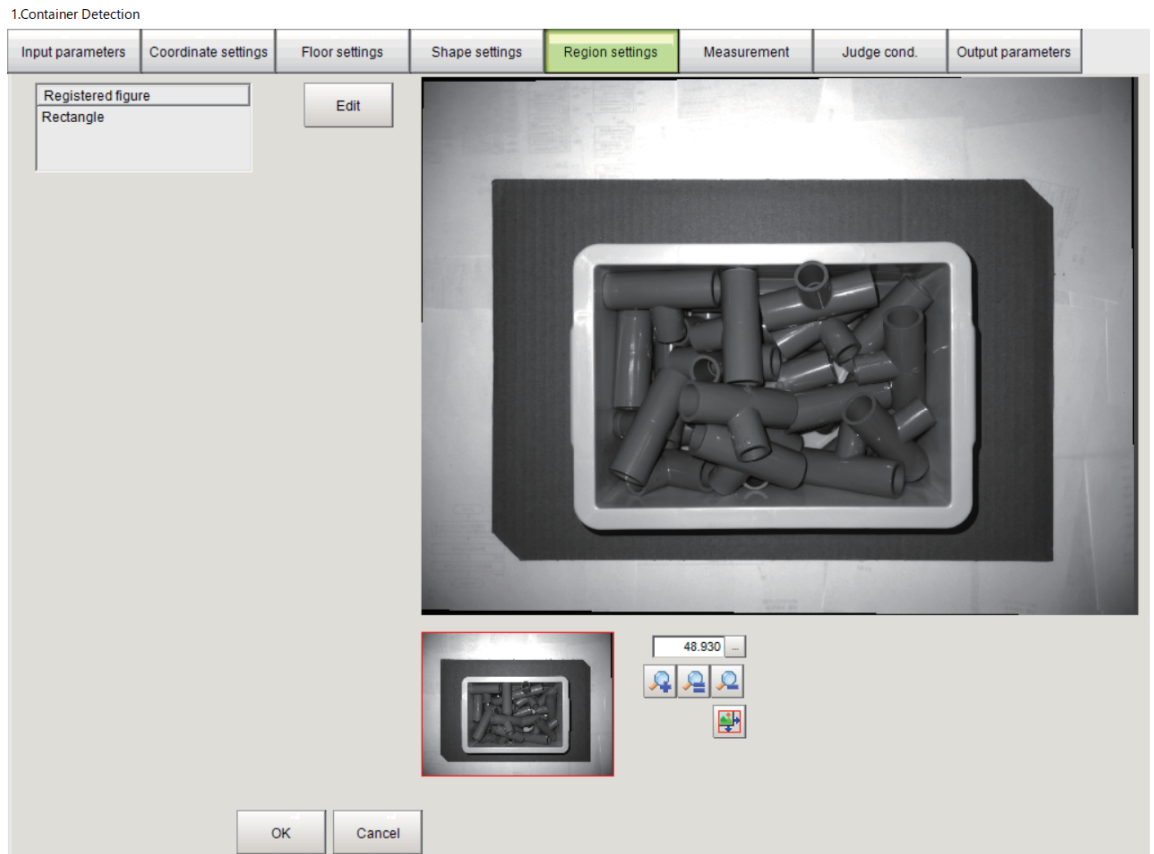

- 2 Click **Edit**.
The *Figure Setting* area is displayed.
- 3 Set the region in which to search for the container.
The rectangle covering the entire screen is set. Adjust the size and position of the rectangle.
- 4 Click **OK** in the *Figure setting* area.
 - **OK**: Changes the settings and returns to the previous menu.
 - **Cancel**: Changes are discarded. Returns to the previous menu.
 - **Apply**: Updates the settings without leaving edit window.

2-3-7 Measurement (Container Detection)

Set the measurement conditions for detecting the container as measurement parameters.

Setting the Measurement Conditions

Set the necessary parameters and processing conditions for the measurement.

- 1 In the Item tab area, click **Measurement**.

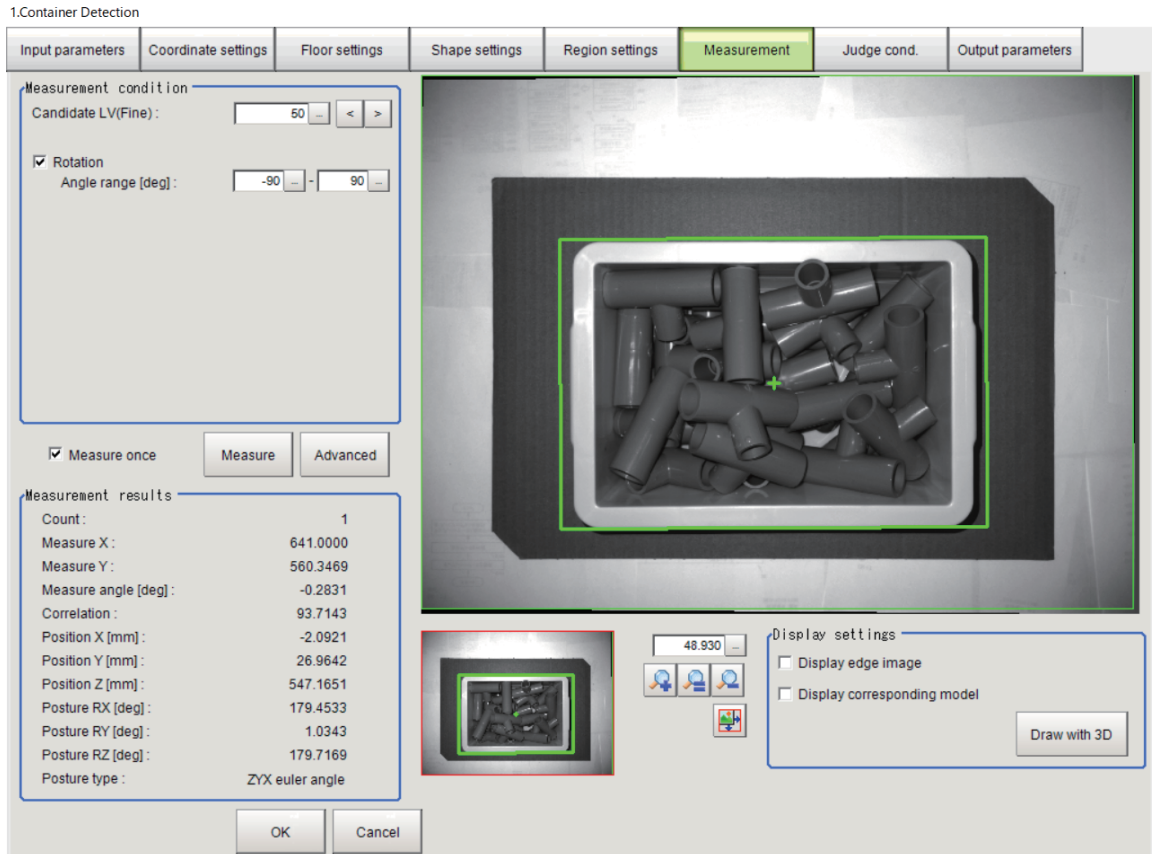

2 Set the value in the **Measurement condition** area.

Setting item	Setting value [Factory default]	Description
Candidate LV (Fine)	0 to 100 [50]	Set the search threshold for detecting the edges of the container. If you cannot search for the container edges stably, decrease the Candidate LV (Fine) value.
Rotation	<ul style="list-style-type: none"> • [Checked] • Unchecked 	Check Rotation if the direction of the detection target is different from that during shape setting.
Angle range [deg]	-180 to 180 [-90] to [90]	This setting is enabled when Rotation is checked. Specify the range of angles in which to perform measurement.

3 Click **Advanced**. Set the value in the **Measurement condition** area.

The container is displayed as an edge image.

Click **Return** to return to the previous menu.

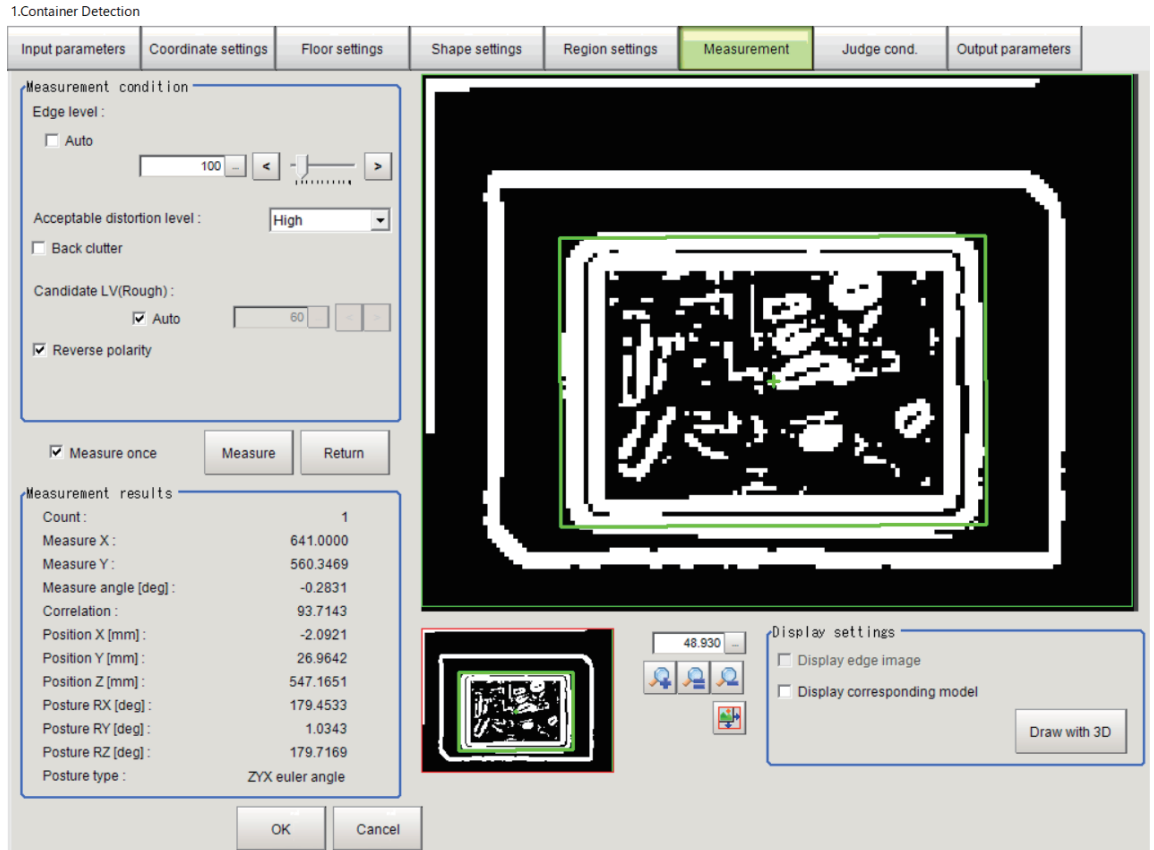

Setting item	Setting value [Factory default]	Description
Edge level	Auto, 0 to 1,024 [100]	Set the lower limit of the Edge level to recognize the edges during measurement. Edges at the Edge level or above will be recognized. If it is difficult to find the edges, decrease the Edge level . If there is an effect of noise, increase the Edge level . Check <i>Auto</i> to adjust the Edge level automatically.
Acceptable distortion level	<ul style="list-style-type: none"> Low Middle [High] 	Set the degree of effect on the correlation value when the edges are uneven. To prevent the reduction of the correlation value due to the effect of uneven edges, set the Acceptable distortion level to <i>High</i> .
Back clutter	<ul style="list-style-type: none"> Checked [Unchecked] 	To stabilize the measurement when there are many edges on the background of the detection target, check Back clutter .
Candidate LV (Rough)	Auto, 0 to 100 [Auto]	Set the threshold for finding candidate points in a rough search. If you cannot search stably, decrease the value. Check <i>Auto</i> to adjust the Candidate LV (Rough) value automatically.
Reverse polarity	<ul style="list-style-type: none"> Checked [Unchecked] 	To detect a glossy workpiece or other object that causes the relationship of light and shade to be reversed, check Reverse polarity .

- 4** When the setting has been changed, click **Measure** to verify whether measurement can be performed correctly.

Setting item	Setting value [Factory default]	Description
Measure once	<ul style="list-style-type: none"> [Checked] Unchecked 	<ul style="list-style-type: none"> Checked: When the container stays in the same place, check the item so that the container is detected only once on the setting screen and not detected in each measurement. The results of the detection on the setting screen is retained. Unchecked: Uncheck this to detect the container in each measurement.

Item	Description
Count	Detection count with the current settings
Measure X	X coordinate of the detection position on the image
Measure Y	Y coordinate of the detection position on the image
Measure angle [deg]	Angle of the detection position on the image
Correlation	Correlation
Position X [mm]	Center position of the container bottom seen from the output coordinate system set from Coordinate settings
Position Y [mm]	
Position Z [mm]	
Posture RX [deg] / Posture RZ [deg]	Posture of the container seen from the output coordinate system set from Coordinate settings If you set Posture type to <i>ZYZ Euler angle</i> , RX is replaced with RZ .
Posture RY [deg]	
Posture RZ [deg]	
Posture type	The setting of the referenced HandEye calibration data in Coordinate settings is displayed.

Checking Measurement Results in the Image (Display Settings)

You can change the display settings to check the processing conditions for measurements on the image.

- 1 Set the value in the **Display settings** area.

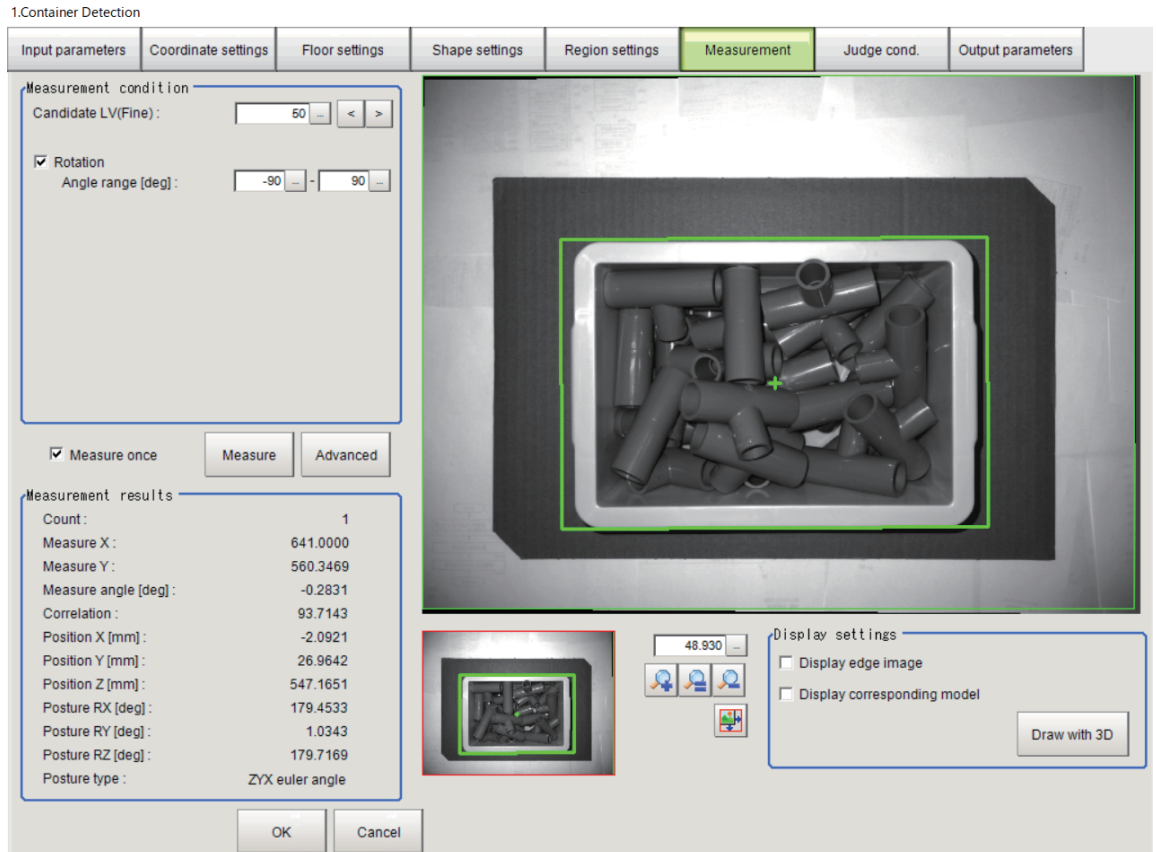

Setting item	Setting value [Factory default]	Description
Display edge image	<ul style="list-style-type: none"> • Checked • [Unchecked] 	Check this to display the edge image, which represents the contour features extracted from the measurement image. Uncheck this item to display the measurement image.
Display corresponding model	<ul style="list-style-type: none"> • Checked • [Unchecked] 	Check this to superimpose the rough search model on the displayed image.
Draw with 3D	-	Click this to start the 3D result display tool FZ-3DVisualizer . The 3D result display tool FZ-3DVisualizer displays a 3D model of the container built with the set parameters, together with a 3D display of the measurement point cloud. <i>Checking 3D Measurement Results (FZ-3DVisualizer) on page 2-60</i>

- 2** Check the conditions of measurement processing on the image and set the measurement parameters.

2-3-8 Judge cond. (Container Detection)

Set the judgment conditions for the measurement results.

Set the upper and lower values to judge the measurement result. When the measurement result value is within the upper and lower values, Judgment is OK (pass). When the measurement result value exceeds either the upper or lower value Judgment is NG (failure). Although the judgment result for the processing Unit is OK when the judgment for all measurements is OK, it will be NG if any measurement result is NG.

1 In the Item tab area, click **Judge cond..**

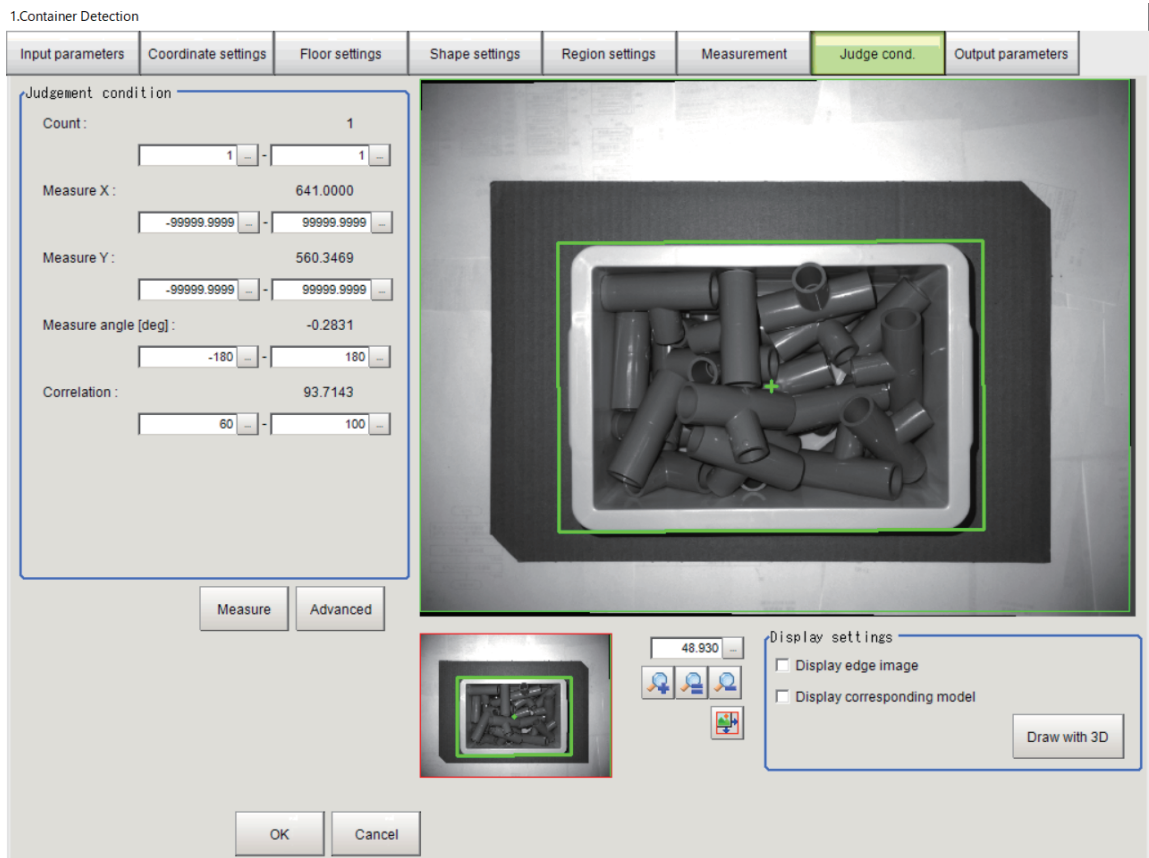

2 Set the value in the **Judgement condition** area.

Setting item	Setting value [Factory default]	Description
Count	0 to 128 [1] to [1]	Set the upper and lower limits of the detection count to judge as OK.
Measure X	-99,999.9999 to 99,999.9999 [-99,999.9999] to [99,999.9999]	Set the upper and lower limits of the measurement point X to judge as OK.
Measure Y	-99,999.9999 to 99,999.9999 [-99,999.9999] to [99,999.9999]	Set the upper and lower limits of the measurement point Y to judge as OK.
Measure angle [deg]	-180 to 180 [-180] to [180]	Set the upper and lower limits of the detection angle to judge as OK.
Correlation	0 to 100 [60] to [100]	Set the upper and lower limits of the correlation value to judge as OK.

3 Click **Advanced**. Set the value in the **Judgement condition** area. Click **Return** to return to the previous menu.

Judgement condition

Position X [mm] : -2.0921
 -

Position Y [mm] : 26.9642
 -

Position Z [mm] : 547.1651
 -

Posture RX [deg] : 179.4533
 -

Posture RY [deg] : 1.0343
 -

Posture RZ [deg] : 179.7169
 -

Posture type : ZYX euler angle (*)

Measure Return

OK Cancel

Setting item	Setting value [Factory default]	Description
Position X [mm]	[-10,000.0000] to [10,000.0000]	Set the range of detected container positions to judge as OK. The range is for the center position of the container bottom seen from the output coordinate system set from Coordinate settings .
Position Y [mm]	[-10,000.0000] to [10,000.0000]	
Position Z [mm]	[-10,000.0000] to [10,000.0000]	
Posture RX [deg] / Posture RZ [deg]	[-180] to [180]	Set the range of detected container postures to judge as OK. The range is for the posture of the container seen from the output coordinate system set from Coordinate settings . If you set Posture type to <i>ZYZ Euler angle</i> , RX is replaced with RZ .
Posture RY [deg]	[-180] to [180]	
Posture RZ [deg]	[-180] to [180]	
Posture type	<ul style="list-style-type: none"> • [ZYX Euler angle] • ZYZ Euler angle • XYZ Euler angle 	Set the posture angle type to use for judgment. The setting of the referenced HandEye calibration data in Coordinate settings is indicated with (*).

- 4** When the setting has been changed, click **Measure** to verify whether measurement can be performed correctly.

Checking Measurement Results in the Image (Display Settings)

You can change the display settings to check the processing conditions for measurements on the image.

- 1 Set the value in the **Display settings** area.

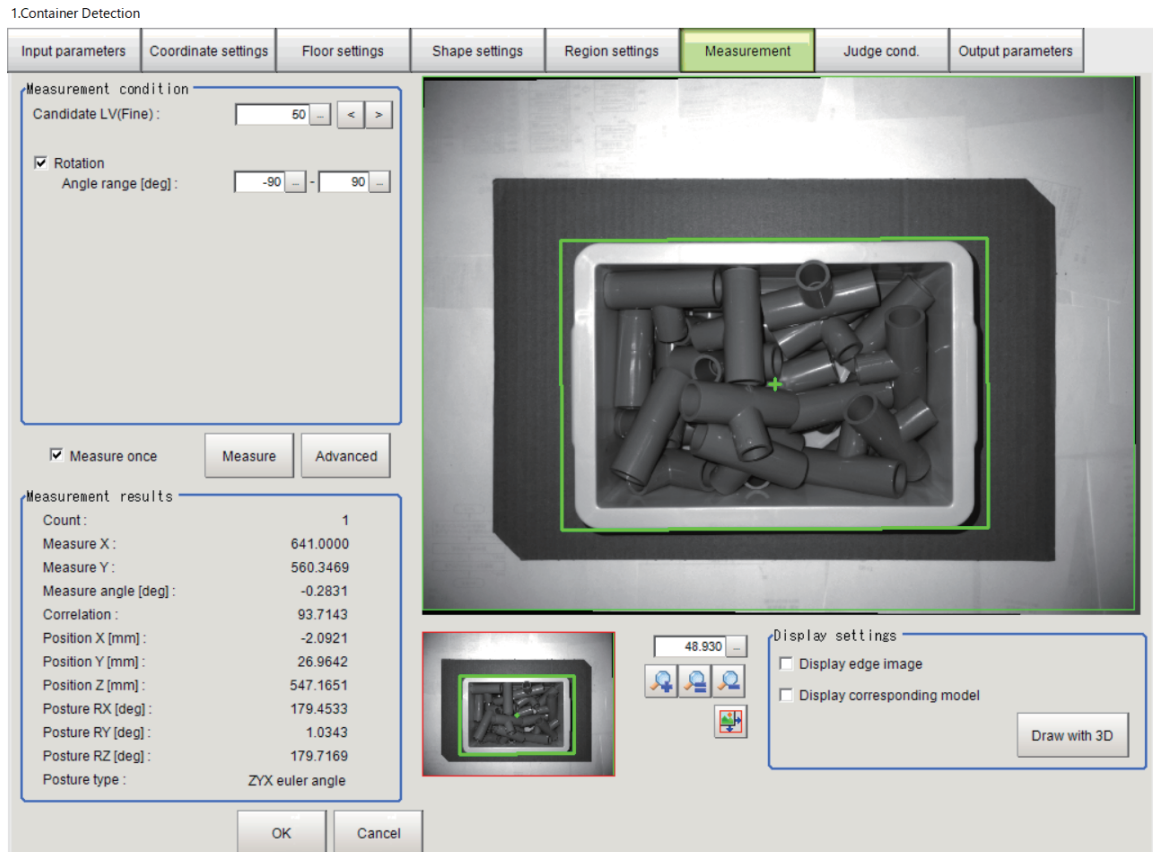

Setting item	Setting value [Factory default]	Description
Display edge image	<ul style="list-style-type: none"> • Checked • [Unchecked] 	Check this to display the edge image, which represents the contour features extracted from the measurement image. Uncheck this item to display the measurement image.
Display corresponding model	<ul style="list-style-type: none"> • Checked • [Unchecked] 	Check this to superimpose the rough search model on the displayed image.
Draw with 3D	-	Click this to start the 3D result display tool FZ-3DVisualizer . The 3D result display tool FZ-3DVisualizer displays a 3D model of the container built with the set parameters, together with a 3D display of the measurement point cloud. <i>Checking 3D Measurement Results (FZ-3DVisualizer) on page 2-60</i>

- 2 Check the conditions of measurement processing on the image and set the measurement parameters.

2-3-9 Output Parameters (Container Detection)

Select how to handle the coordinates to be output to the external device as measurement results. This item can be changed as necessary. Normally, the factory default value will be used.

- 1 In the Item tab area, click **Output parameter**.
- 2 Select the *Reflect to overall judgment*.

Setting item	Setting value [Factory default]	Description
Reflect to overall judgment	<ul style="list-style-type: none"> • [ON] • OFF 	-

2-3-10 Key Points for Test Measurement and Adjustment (Container Detection)

The following content is displayed in the *Detail result* area as text.



Precautions for Correct Use

Executing test measurements will also update the measurement results and the figures in the image.

Displayed item	Description
Judge	Judgment result 0: No judgment (unmeasured) 1: Judgment result OK -1: Judgment result NG -10: Error (image format mismatch) -11: Error (unregistered model) -12: Error (insufficient memory) -20: Error (other errors)
Position X [mm]	Center position X of the container bottom seen from the output coordinate system set from Coordinate settings
Position Y [mm]	Center position Y of the container bottom seen from the output coordinate system set from Coordinate settings
Position Z [mm]	Center position Z of the container bottom seen from the output coordinate system set from Coordinate settings
Posture RX [deg] / Posture RZ [deg]	Posture RX of the container seen from the output coordinate system set from Coordinate settings If you set Posture type to <i>XYZ Euler angle</i> , RX is replaced with RZ .
Posture RY [deg]	Posture RY of the container seen from the output coordinate system set from Coordinate settings
Posture RZ [deg]	Posture RZ of the container seen from the output coordinate system set from Coordinate settings
Posture type	Posture type for the detected container posture

The image specified in the Sub-image number in the image display setting is displayed in the *Image Display* area.

Sub-image number	Description of image to be displayed
0	The coordinate axis figure of the detected plane is superimposed on the measurement image.
1	The measurement result figure is superimposed on the front image.
2	The measurement result figure and the corresponding model display image are superimposed on the front image.
3	The measurement result figure and the edge image are superimposed on the front image.
4	The measurement result figure, the edge image and the corresponding model display image are superimposed on the front image.

Key Points for Adjustment (Container Detection)

Adjust the setting parameters referring to the following points.

● When tabs that follow the Coordinate settings tab are disabled

Parameter to be adjusted	Remedy
Coordinate settings	The Coordinate settings tab may not be set appropriately. If a warning message is displayed in the Coordinate settings tab, review the settings accordingly. If the coordinate settings are not completed, you cannot set the items in tabs that follow this tab.

● When floor detection fails

Parameter to be adjusted	Remedy
Floor settings	The minimum number of 3D data items required for floor detection are not included in the measurement region. Set the floor region to include the required 3D data of the floor.
	The measurement region may not be a plane (floor). Adjust the floor region.

● When the 2D image is not displayed in the Region settings or Measurement tab

Parameter to be adjusted	Remedy
Camera Image Input AOS processing item	The 2D image may not be set in the Camera Image Input AOS processing item. Check 2D imaging ON in the Camera setting(2D) tab in the Camera Image Input AOS processing item and confirm that Measurement image 0 in Output setting is set to <i>Captured image (2D)</i> .

● When the container image seen from the top is not displayed in the Region settings or Measurement tab

Parameter to be adjusted	Remedy
Floor settings	If the floor is not measured yet, the container image seen from the top is not displayed. In the Floor settings tab, confirm that the Z coordinate axis (blue) of the floor points to the normal direction of the floor and detect the floor again.

● When the container cannot be detected

Parameter to be adjusted	Remedy
Camera Image Input AOS processing item	The 2D image may not be set in the Camera Image Input AOS processing item. Check 2D imaging ON in the Camera setting(2D) tab in the Camera Image Input AOS processing item and confirm that Measurement image 0 in Output setting is set to <i>Captured image (2D)</i> .
Coordinate settings	The settings (evaluation values of expressions) for the flange position/posture seen from the robot base coordinate system may be different from the position/posture of the robot when the measurement image was captured. The current capturing posture of the camera is calculated based on the amount of change from the capturing position/posture of the robot when the floor was registered. If the correct camera posture cannot be calculated, the container detection fails because the container image seen from the top cannot be generated. Check if the evaluation values of the expressions in use are the intended values. If there are unintended values, update the values of the relevant system variables.
Floor settings	Even when the floor was correctly registered before, the floor in the current environment may be different from what it was. The container detection fails because the container image seen from the top is generated and searched based on the floor registered before. Detect the floor again.
Shape settings	The image used for container detection may be significantly deviated from the measurement image. Review the Shape settings parameters.
Measurement	The edges may not be adequately extracted due to insufficient contrast between the floor and the container. Adjust the Edge level setting, or adjust the background. The parameters for container detection may be incorrect. Confirm that the measurement conditions in the Measurement tab are correct.

● When the container detected by the 3D result display tool is out of position

Parameter to be adjusted	Remedy
Floor settings	Even when the floor was correctly registered before, the floor in the current environment may be different from what it was. The container detection fails because the container image seen from the top is generated and searched based on the floor registered before. Detect the floor again.
Shape settings	The image used for container detection may be significantly deviated from the measurement image. Review the Shape settings parameters.
Coordinate settings	The settings (evaluation values of expressions) for the flange position/posture seen from the robot base coordinate system may be different from the position/posture of the robot when the measurement image was captured. The current capturing posture of the camera is calculated based on the amount of change from the capturing position/posture of the robot when the floor was registered. If the correct camera posture cannot be calculated, the container detection fails because the container image seen from the top cannot be generated. Check if the evaluation values of the expressions in use are the intended values. If there are unintended values, update the values of the relevant system variables.

2-3-11 Measurement Results for Which Output Is Possible (Container Detection)

The following values can be output using processing items related to result output. It is also possible to reference measurement values from calculation expressions and other processing units.

Measurement items	Character string	Description
Judge	JG	Judgment result 0: No judgment (unmeasured) 1: Judgment result OK -1: Judgment result NG -10: Error (image format mismatch) -11: Error (unregistered model) -12: Error (insufficient memory) -20: Error (other errors)
Position X	PX	Center position X of the container bottom seen from the output coordinate system set from Coordinate settings
Position Y	PY	Center position Y of the container bottom seen from the output coordinate system set from Coordinate settings
Position Z	PZ	Center position Z of the container bottom seen from the output coordinate system set from Coordinate settings
Posture RA	PRA	Posture RX of the container seen from the output coordinate system set from Coordinate settings If you set Posture type to <i>ZYZ Euler angle</i> , RX is replaced with RZ .
Posture RY	PRB	Posture RY of the container seen from the output coordinate system set from Coordinate settings
Posture RZ	PRC	Posture RZ of the container seen from the output coordinate system set from Coordinate settings
Posture type	PRT	Posture type for the detected container posture 0: ZYX Euler angle, 1: ZYZ Euler angle, 2: XYZ Euler angle
RotMatrix 11	RM11	Rotation matrix expression of the detected container posture seen from the output coordinate system set from Coordinate settings 1 row and 1 column
RotMatrix 12	RM12	Rotation matrix expression of the detected container posture seen from the output coordinate system set from Coordinate settings 1 row and 2 columns
RotMatrix 13	RM13	Rotation matrix expression of the detected container posture seen from the output coordinate system set from Coordinate settings 1 row and 3 columns
RotMatrix 21	RM21	Rotation matrix expression of the detected container posture seen from the output coordinate system set from Coordinate settings 2 rows and 1 column

Measurement items	Character string	Description
RotMatrix 22	RM22	Rotation matrix expression of the detected container posture seen from the output coordinate system set from Coordinate settings 2 rows and 2 columns
RotMatrix 23	RM23	Rotation matrix expression of the detected container posture seen from the output coordinate system set from Coordinate settings 2 rows and 3 columns
RotMatrix 31	RM31	Rotation matrix expression of the detected container posture seen from the output coordinate system set from Coordinate settings 3 rows and 1 column
RotMatrix 32	RM32	Rotation matrix expression of the detected container posture seen from the output coordinate system set from Coordinate settings 3 rows and 2 columns
RotMatrix 33	RM33	Rotation matrix expression of the detected container posture seen from the output coordinate system set from Coordinate settings 3 rows and 3 columns

2-3-12 External Reference Tables (Container Detection)

No.	Data name	Data ident	Set/Get	Data range
0	Judge	judge	Get only	0: No judgment (unmeasured), 1: Judgment result OK, -1: Judgment result NG, -10: Error (image format mismatch), -11: Error (unregistered model), -12: Error (insufficient memory), -20: Error (other errors)
6	Position X	planeCoordX	Get only	-10,000.0000 to 10,000.0000 [mm] Robot base coord
7	Position Y	planeCoordY	Get only	-10,000.0000 to 10,000.0000 [mm] Robot base coord
8	Position Z	planeCoordZ	Get only	-10,000.0000 to 10,000.0000 [mm] Robot base coord
9	Posture RA	planeCoordRA	Get only	-180.0000 to 180.0000 [deg] Robot base coord
10	Posture RY	planeCoordRB	Get only	-180.0000 to 180.0000 [deg] Robot base coord
11	Posture RZ	planeCoordRC	Get only	-180.0000 to 180.0000 [deg] Robot base coord
12	Posture type	planeCoordRType	Get only	0: ZYX Euler angle, 1: ZYZ Euler angle, 2: XYZ Euler angle
13	RotMatrix11	planeRotMat11	Get only	-1.0000 to 1.0000 Robot base coord

No.	Data name	Data ident	Set/Get	Data range
14	RotMatrix12	planeRotMat12	Get only	-1.0000 to 1.0000 Robot base coord
15	RotMatrix13	planeRotMat13	Get only	-1.0000 to 1.0000 Robot base coord
16	RotMatrix21	planeRotMat21	Get only	-1.0000 to 1.0000 Robot base coord
17	RotMatrix22	planeRotMat22	Get only	-1.0000 to 1.0000 Robot base coord
18	RotMatrix23	planeRotMat23	Get only	-1.0000 to 1.0000 Robot base coord
19	RotMatrix31	planeRotMat31	Get only	-1.0000 to 1.0000 Robot base coord
20	RotMatrix32	planeRotMat32	Get only	-1.0000 to 1.0000 Robot base coord
21	RotMatrix33	planeRotMat33	Get only	-1.0000 to 1.0000 Robot base coord
22	Position X (camera coord.)	planeCoordCX	Get only	-10,000.0000 to 10,000.0000 [mm] Camera coord
23	Position Y (camera coord.)	planeCoordCY	Get only	-10,000.0000 to 10,000.0000 [mm] Camera coord
24	Position Z (camera coord.)	planeCoordCZ	Get only	-10,000.0000 to 10,000.0000 [mm] Camera coord
25	Posture RA (camera coord.)	planeCoordCRA	Get only	-180.0000 to 180.0000 [deg] Camera coord
26	Posture RY (camera coord.)	planeCoordCRB	Get only	-180.0000 to 180.0000 [deg] Camera coord
27	Posture RZ (camera coord.)	planeCoordCRC	Get only	-180.0000 to 180.0000 [deg] Camera coord
28	Posture type (camera coord.)	planeCoordCRTtype	Get only	0: ZYX Euler angle, 1: ZYZ Euler angle, 2: XYZ Euler angle
29	RotMatrix11 (camera coord.)	planeRotMatC11	Get only	-1.0000 to 1.0000 Camera coord
30	RotMatrix12 (camera coord.)	planeRotMatC12	Get only	-1.0000 to 1.0000 Camera coord
31	RotMatrix13 (camera coord.)	planeRotMatC13	Get only	-1.0000 to 1.0000 Camera coord
32	RotMatrix21 (camera coord.)	planeRotMatC21	Get only	-1.0000 to 1.0000 Camera coord
33	RotMatrix22 (camera coord.)	planeRotMatC22	Get only	-1.0000 to 1.0000 Camera coord
34	RotMatrix23 (camera coord.)	planeRotMatC23	Get only	-1.0000 to 1.0000 Camera coord
35	RotMatrix31 (camera coord.)	planeRotMatC31	Get only	-1.0000 to 1.0000 Camera coord
36	RotMatrix32 (camera coord.)	planeRotMatC32	Get only	-1.0000 to 1.0000 Camera coord
37	RotMatrix33 (camera coord.)	planeRotMatC33	Get only	-1.0000 to 1.0000 Camera coord
38	Coefficient of floor equation A	planeNormalA	Get only	Robot base coord

No.	Data name	Data ident	Set/Get	Data range
39	Coefficient of floor equation B	planeNormalB	Get only	Robot base coord
40	Coefficient of floor equation C	planeNormalC	Get only	Robot base coord
41	Coefficient of floor equation D	planeNormalD	Get only	10.0000 to 10,000.0000 Robot base coord
42	Coefficient of floor equation A (camera coord.)	planeNormalCA	Get only	Camera coord
43	Coefficient of floor equation B (camera coord.)	planeNormalCB	Get only	Camera coord
44	Coefficient of floor equation C (camera coord.)	planeNormalCC	Get only	Camera coord
45	Coefficient of floor equation D (camera coord.)	planeNormalCD	Get only	10.0000 to 10,000.0000 Camera coord
46	Judge (search)	searchJudge	Get only	0: No judgment (unmeasured), 1: Judgment result OK, -1: Judgment result NG, -10: Error (image format mismatch), -11: Error (unregistered model), -12: Error (insufficient memory), -20: Error (other errors)
47	Count	count	Get only	0 to 1,000
48	Measure X	positionX	Get only	-99,999.9999 to 99,999.9999
49	Measure Y	positionY	Get only	-99,999.9999 to 99,999.9999
50	Measure angle	angle	Get only	-180 to 180 [deg]
51	Correlation	correlation	Get only	0 to 100
101	Ref. unit number of 3D Imaging unit	camera3dUnitNo	Set/Get	-2 to 9,999
108	Display image kind	ImageDispKind	Set/Get	0: Input - Measure image 0, 1: Camera - Depth image, 2: Camera - Captured(2D), 3: Camera - Captured(3D)
110	Ref. scene number of handeye data unit	handeyeSceneNo	Set/Get	-1 to 1,023
111	Ref. unit number of handeye data unit	handeyeUnitNo	Set/Get	-1 to 9,999
112	flange position X (expr. value)	robotCoordX	Set/Get	-10,000.0000 to 10,000.0000 [mm] Robot base coord
113	flange position Y (expr. value)	robotCoordY	Set/Get	-10,000.0000 to 10,000.0000 [mm] Robot base coord
114	flange position Z (expr. value)	robotCoordZ	Set/Get	-10,000.0000 to 10,000.0000 [mm] Robot base coord
115	flange posture RA (expr. value)	robotCoordRA	Set/Get	-180.0000 to 180.0000 [deg] Robot base coord
116	flange posture RY (expr. value)	robotCoordRB	Set/Get	-180.0000 to 180.0000 [deg] Robot base coord

No.	Data name	Data ident	Set/Get	Data range
117	flange posture RZ (expr. value)	robotCoordRC	Set/Get	-180.0000 to 180.0000 [deg] Robot base coord
121	Floor offset (expr. value)	planeOffset	Set/Get	-10,000.0000 to 10,000.0000 [mm] Along the normal
142	Width (x axis)	containerWidth	Set/Get	10.0000 to 10,000.0000 [mm]
143	Depth (y axis)	containerDepth	Set/Get	10.0000 to 10,000.0000 [mm]
144	Height (inner)	containerHeightI	Set/Get	10.0000 to 10,000.0000 [mm]
145	Height (outer)	containerHeightO	Set/Get	10.0000 to 10,000.0000 [mm]
146	Rim (x axis)	containerThickW	Set/Get	0.0000 to 1,000.0000 [mm]
147	Rim (y axis)	containerThickD	Set/Get	0.0000 to 1,000.0000 [mm]
148	Stacking count	containerCount	Set/Get	1 to 2,147,483,647
149	Stacking overlap	containerOverlap	Set/Get	0.0000 to 1,000.0000 [mm]
162	Measure once	searchOne	Set/Get	0: Disable, 1: Enable
163	Reverse	reverse	Set/Get	0: Disable, 1: Enable
164	Candidate Point Level (Fine)	candidateLevel	Set/Get	0 to 100
168	With rotation	rotation	Set/Get	0: Disable, 1: Enable
169	Lower limit of the rotation angle	startAngle	Set/Get	-180.0000 to 180.0000 [deg]
170	Upper limit of the rotation angle	endAngle	Set/Get	-180.0000 to 180.0000 [deg]
180	Edge level (Measure) auto setting	edgeLevelMeasAuto	Set/Get	0: Disable, 1: Enable
181	Edge level (Measure)	edgeLevelMeas	Set/Get	0 to 1,024
184	Acceptable distortion level	distLevel	Set/Get	0: Low, 1: Middle, 2: High
185	Back clutter	complexBackGround	Set/Get	0: Disable, 1: Enable
190	Candidate Point Level (Rough) auto setting	candidateLevel-RoughAuto	Set/Get	0: Disable, 1: Enable
191	Candidate Point Level (Rough)	candidateLevel-Rough	Set/Get	0 to 100
197	Lower limit of the detected number	lowerCount	Set/Get	0 to 128
198	Upper limit of the detected number	upperCount	Set/Get	0 to 128
199	Lower limit of the measure X	lowerX	Set/Get	-99,999.9999 to 99,999.9999
200	Upper limit of the measure X	upperX	Set/Get	-99,999.9999 to 99,999.9999
201	Lower limit of the measure Y	lowerY	Set/Get	-99,999.9999 to 99,999.9999
202	Upper limit of the measure Y	upperY	Set/Get	-99,999.9999 to 99,999.9999

No.	Data name	Data ident	Set/Get	Data range
203	Lower limit of the measure angle	lowerAngle	Set/Get	-180.0000 to 180.0000 [deg]
204	Upper limit of the measure angle	upperAngle	Set/Get	-180.0000 to 180.0000 [deg]
205	Lower limit of the correlation	lowerCorrelation	Set/Get	0 to 100
206	Upper limit of the correlation	upperCorrelation	Set/Get	0 to 100
207	Lower limit of position X	lowerTX	Set/Get	-10,000.0000 to 10,000.0000 [mm] Robot base coord
208	Upper limit of position X	upperTX	Set/Get	-10,000.0000 to 10,000.0000 [mm] Robot base coord
209	Lower limit of position Y	lowerTY	Set/Get	-10,000.0000 to 10,000.0000 [mm] Robot base coord
210	Upper limit of position Y	upperTY	Set/Get	-10,000.0000 to 10,000.0000 [mm] Robot base coord
211	Lower limit of position Z	lowerTZ	Set/Get	-10,000.0000 to 10,000.0000 [mm] Robot base coord
212	Upper limit of position Z	upperTZ	Set/Get	-10,000.0000 to 10,000.0000 [mm] Robot base coord
213	Lower limit of posture RA	lowerRA	Set/Get	-180.0000 to 180.0000 [deg] Robot base coord
214	Upper limit of posture RA	upperRA	Set/Get	-180.0000 to 180.0000 [deg] Robot base coord
215	Lower limit of posture RY	upperRB	Set/Get	-180.0000 to 180.0000 [deg] Robot base coord
216	Upper limit of posture RY	lowerRB	Set/Get	-180.0000 to 180.0000 [deg] Robot base coord
217	Lower limit of posture RZ	upperRC	Set/Get	-180.0000 to 180.0000 [deg] Robot base coord
218	Upper limit of posture RZ	lowerRC	Set/Get	-180.0000 to 180.0000 [deg] Robot base coord
219	Posture type	judgePostureType	Set/Get	0: ZYX Euler angle, 1: ZYZ Euler angle, 2: XYZ Euler angle For confirming
220	Reflect to overall judgement	overallJudge	Set/Get	0: ON, 1: OFF
1009	Robot mount	machineMount	Get only	-1: Unspecified, 0: Floor mount, 1: Ceiling mount
1010	Robot type	machineType	Get only	-1: Unspecified, 0: 3-axis(XYZ) robot, 1: 4-axis(XYZR) robot, 2: 6-axis(XYZWPR) robot
1011	Robot posture type	poseRotationType	Get only	-1: Unspecified, 0: ZYX Euler angle, 1: ZYZ Euler angle, 2: XYZ Euler angle
1012	Camera mount	cameraMount	Get only	-1: Unspecified, 0: Fixed camera, 1: On hand camera
1020	flange position X	robotCoordXEval	Get only	-10,000.0000 to 10,000.0000 [mm] Robot base coord

No.	Data name	Data ident	Set/Get	Data range
1021	flange position Y	robotCoordYEval	Get only	-10,000.0000 to 10,000.0000 [mm] Robot base coord
1022	flange position Z	robotCoordZEval	Get only	-10,000.0000 to 10,000.0000 [mm] Robot base coord
1023	flange posture RA	robotCoordRAEval	Get only	-180.0000 to 180.0000 [deg] Robot base coord
1024	flange posture RY	robotCoordRBEval	Get only	-180.0000 to 180.0000 [deg] Robot base coord
1025	flange posture RZ	robotCoordRCEval	Get only	-180.0000 to 180.0000 [deg] Robot base coord
1026	flange posture type	robotCoordRTEval	Get only	0: ZYX Euler angle, 1: ZYZ Euler angle, 2: XYZ Euler angle
1027	Floor offset	planeOffseteval	Get only	-10,000.0000 to 10,000.0000 [mm] Along the normal
1029	Camera position X	cam2refXEval	Get only	-10,000.0000 to 10,000.0000 [mm] Robot base coord
1030	Camera position Y	cam2refYEval	Get only	-10,000.0000 to 10,000.0000 [mm] Robot base coord
1031	Camera position Z	cam2refZEval	Get only	-10,000.0000 to 10,000.0000 [mm] Robot base coord
1032	Camera posture RA	cam2refRAEval	Get only	-180.0000 to 180.0000 [deg] Robot base coord
1033	Camera posture RY	cam2refRBEval	Get only	-180.0000 to 180.0000 [deg] Robot base coord
1034	Camera posture RZ	cam2refRCEval	Get only	-180.0000 to 180.0000 [deg] Robot base coord
1035	Camera posture type	cam2refRTEval	Get only	0: ZYX Euler angle, 1: ZYZ Euler angle, 2: XYZ Euler angle
1051	Position X (origin)	cntnrCoordX	Get only	-10,000.0000 to 10,000.0000 [mm] Robot base coord
1052	Position Y (origin)	cntnrCoordY	Get only	-10,000.0000 to 10,000.0000 [mm] Robot base coord
1053	Position Z (origin)	cntnrCoordZ	Get only	-10,000.0000 to 10,000.0000 [mm] Robot base coord
1054	Posture RA (origin)	cntnrCoordRA	Get only	-180.0000 to 180.0000 [deg] Robot base coord
1055	Posture RY (origin)	cntnrCoordRB	Get only	-180.0000 to 180.0000 [deg] Robot base coord
1056	Posture RZ (origin)	cntnrCoordRC	Get only	-180.0000 to 180.0000 [deg] Robot base coord
1057	Posture type (origin)	cntnrCoordRType	Get only	0: ZYX Euler angle, 1: ZYZ Euler angle, 2: XYZ Euler angle
1058	RotMatrix11 (origin)	cntnrRotMat11	Get only	-1.0000 to 1.0000 Robot base coord
1059	RotMatrix12 (origin)	cntnrRotMat12	Get only	-1.0000 to 1.0000 Robot base coord
1060	RotMatrix13 (origin)	cntnrRotMat13	Get only	-1.0000 to 1.0000 Robot base coord

No.	Data name	Data ident	Set/Get	Data range
1061	RotMatrix21 (origin)	cntnrRotMat21	Get only	-1.0000 to 1.0000 Robot base coord
1062	RotMatrix22 (origin)	cntnrRotMat22	Get only	-1.0000 to 1.0000 Robot base coord
1063	RotMatrix23 (origin)	cntnrRotMat23	Get only	-1.0000 to 1.0000 Robot base coord
1064	RotMatrix31 (origin)	cntnrRotMat31	Get only	-1.0000 to 1.0000 Robot base coord
1065	RotMatrix32 (origin)	cntnrRotMat32	Get only	-1.0000 to 1.0000 Robot base coord
1066	RotMatrix33 (origin)	cntnrRotMat33	Get only	-1.0000 to 1.0000 Robot base coord
1067	Position X (origin) (camera coord.)	cntnrCoordCX	Get only	-10,000.0000 to 10,000.0000 [mm] Camera coord
1068	Position Y (origin) (camera coord.)	cntnrCoordCY	Get only	-10,000.0000 to 10,000.0000 [mm] Camera coord
1069	Position Z (origin) (camera coord.)	cntnrCoordCZ	Get only	-10,000.0000 to 10,000.0000 [mm] Camera coord
1070	Posture RA (origin) (camera coord.)	cntnrCoordCRA	Get only	-180.0000 to 180.0000 [deg] Camera coord
1071	Posture RY (origin) (camera coord.)	cntnrCoordCRB	Get only	-180.0000 to 180.0000 [deg] Camera coord
1072	Posture RZ (origin) (camera coord.)	cntnrCoordCRC	Get only	-180.0000 to 180.0000 [deg] Camera coord
1073	Posture type (origin) (camera coord.)	cntnrCoordCRType	Get only	0: ZYX Euler angle, 1: ZYZ Euler angle, 2: XYZ Euler angle
1074	RotMatrix11 (origin) (camera coord.)	cntnrRotMatC11	Get only	-1.0000 to 1.0000 Camera coord
1075	RotMatrix12 (origin) (camera coord.)	cntnrRotMatC12	Get only	-1.0000 to 1.0000 Camera coord
1076	RotMatrix13 (origin) (camera coord.)	cntnrRotMatC13	Get only	-1.0000 to 1.0000 Camera coord
1077	RotMatrix21 (origin) (camera coord.)	cntnrRotMatC21	Get only	-1.0000 to 1.0000 Camera coord
1078	RotMatrix22 (origin) (camera coord.)	cntnrRotMatC22	Get only	-1.0000 to 1.0000 Camera coord
1079	RotMatrix23 (origin) (camera coord.)	cntnrRotMatC23	Get only	-1.0000 to 1.0000 Camera coord
1080	RotMatrix31 (origin) (camera coord.)	cntnrRotMatC31	Get only	-1.0000 to 1.0000 Camera coord
1081	RotMatrix32 (origin) (camera coord.)	cntnrRotMatC32	Get only	-1.0000 to 1.0000 Camera coord
1082	RotMatrix33 (origin) (camera coord.)	cntnrRotMatC33	Get only	-1.0000 to 1.0000 Camera coord
1083	Posture RA	planeCoordRAJudge	Get only	-180.0000 to 180.0000 [deg] For confirming
1084	Posture RY	planeCoordRBJudge	Get only	-180.0000 to 180.0000 [deg] For confirming
1085	Posture RZ	planeCoordRCJudge	Get only	-180.0000 to 180.0000 [deg] For confirming

No.	Data name	Data ident	Set/Get	Data range
5004	Register shape	registShape	Get only	0: Enable, 1: Disable

2-4 Grasp Planning

This is a processing item specific to the FH series 3D robot vision system.

To enable the robot connected to the FH series Sensor Controller to grasp the object detected in the **3D Search** processing item, this processing item performs the following operations.

- Determine the target workpiece that is most suitable for grasping (with a minimal risk of physical grasping failure, such as interference with the container or other workpiece).
- Calculate the approach position and angle suitable for grasping.
- Calculate the arm posture suitable for grasping.

Used in the Following Case

When selecting and setting the target workpiece for grasping, when setting the collision detection, when calculating the pose of grasping

Example: Bulk picking of parts in a container

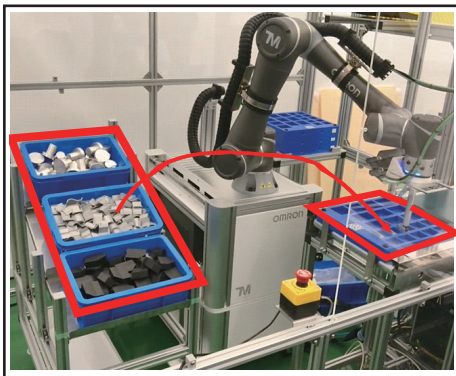

Precautions for Correct Use

- This processing item references the results of the **HandEye Calibration**, **Container Detection**, and **3D Search** processing items. Confirm that the referenced processing items are set correctly.
- Correct measurement is not possible with images that have undergone a coordinate transformation such as Position Compensation or Polar Transformation.

2-4-1 Settings Flow (Grasp Planning)

To set Grasp Planning, follow the steps below.

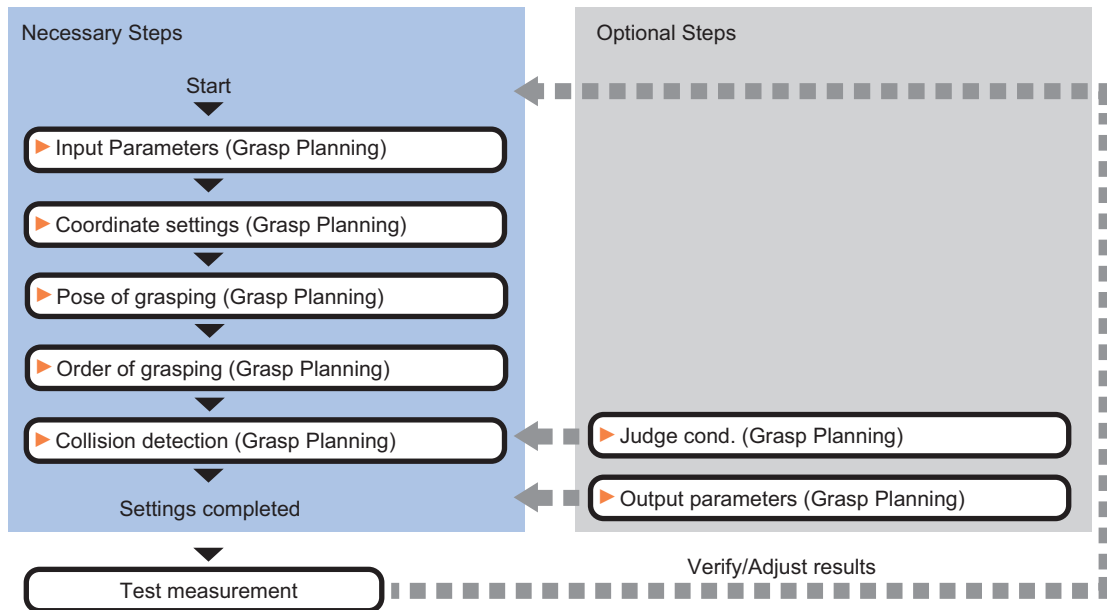

List of Grasp Planning Items

Item	Description
Input parameters	Check the input parameters. <i>2-4-2 Input parameters (Grasp Planning) on page 2-84</i>
Coordinate settings	Set the coordinate system for which to output the measurement results. <i>2-4-3 Coordinate settings (Grasp Planning) on page 2-85</i>
Pose of grasping	Set the pose of grasping. <i>2-4-4 Pose of grasping (Grasp Planning) on page 2-88</i>
Order of grasping	Determine the order of the graspable candidates. <i>2-4-5 Order of grasping (Grasp Planning) on page 2-90</i>
Collision detection	Perform a collision detection. <i>2-4-6 Collision detection (Grasp Planning) on page 2-104</i>
Judge cond.	Set the judgment conditions for the measurement results. <i>2-4-7 Judge cond. (Grasp Planning) on page 2-109</i>
Output parameters	Select how to handle the coordinates to be output to the external device as measurement results. This item can be changed as necessary. Normally, the factory default value will be used. <i>2-4-8 Output Parameters (Grasp Planning) on page 2-115</i>

2-4-2 Input parameters (Grasp Planning)

Check the input parameters.

- 1 In the Item tab area, click the **Input parameter** tab.
In the **Workpiece detection unit settings** area, confirm that the **3D Search** processing item to reference is set.
If not set, review the flow and set it.
In the image area, confirm that the measurement result of the **3D Search** is displayed.

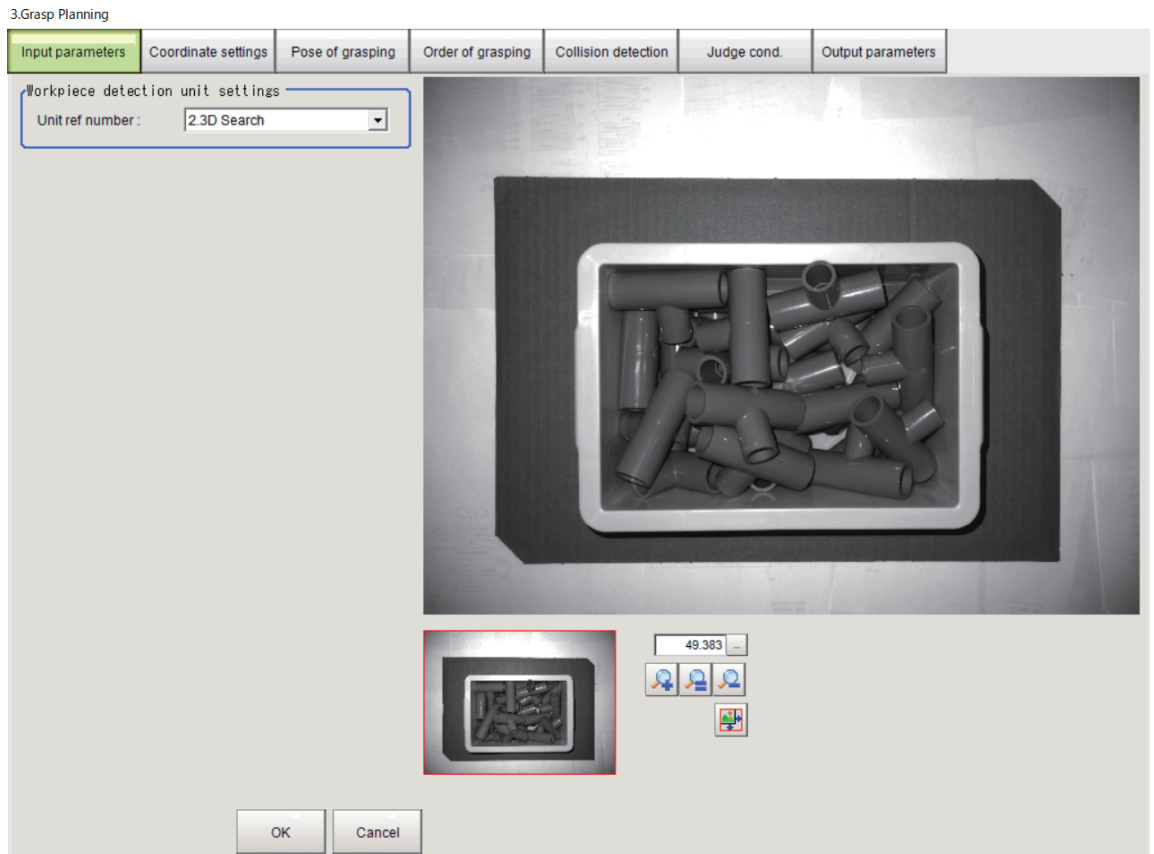

2-4-3 Coordinate settings (Grasp Planning)

Set the coordinate system for which to output the measurement results.

- 1 In the Item tab area, click the **Coordinate settings** tab.

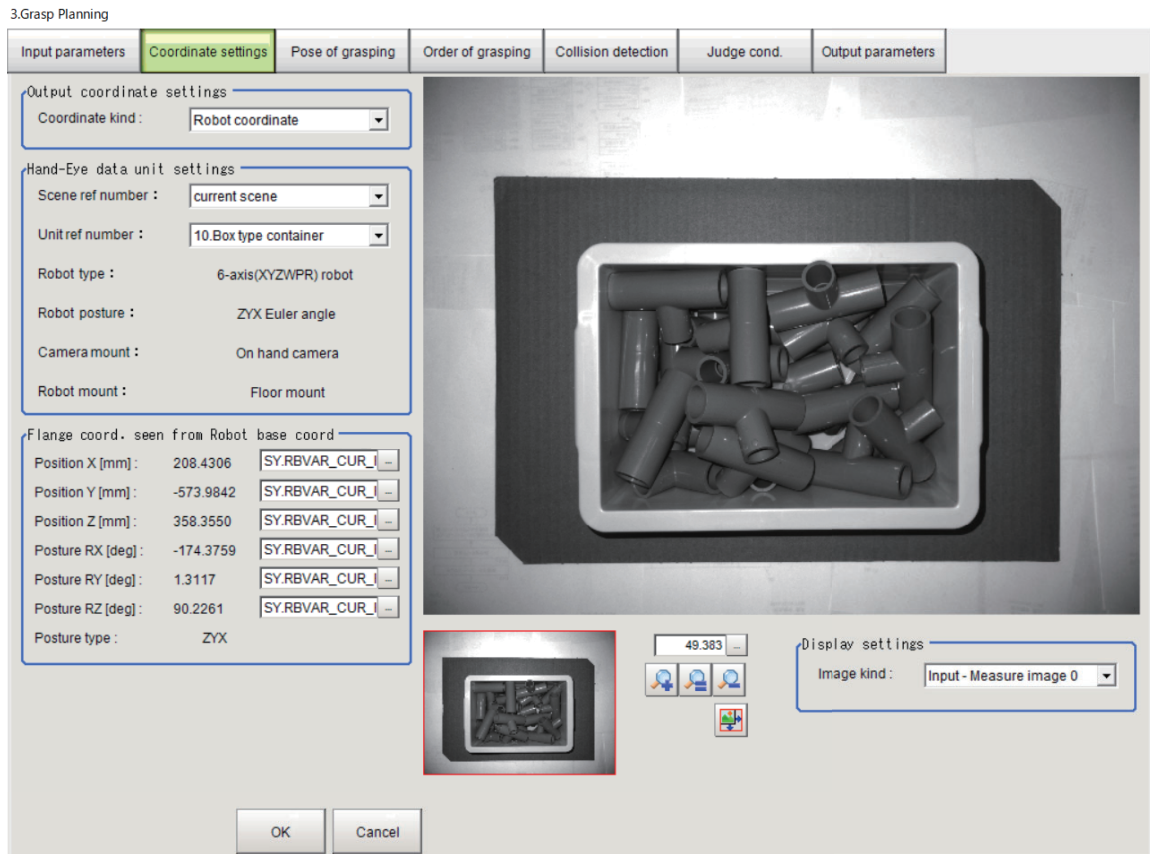

- 2 Set the **Coordinate kind** in the **Output coordinate settings** area. Select *Robot coordinate*.
- 3 In the **Hand-Eye data unit settings** area, select the **HandEye Calibration** processing item to reference.
Information on the selected processing unit is displayed in the **Hand-Eye data unit settings** area. The displayed information depends on the settings for the referenced **HandEye Calibration**.

Output coordinate settings	
Coordinate kind :	Robot coordinate
Hand-Eye data unit settings	
Scene ref number :	current scene
Unit ref number :	10.Box type container
Robot type :	6-axis(XYZWPR) robot
Robot posture :	ZYX Euler angle
Camera mount :	On hand camera
Robot mount :	Floor mount
Flange coord. seen from Robot base coord	
Position X [mm] :	208.4306 SY.RBVAR_CUR_ -
Position Y [mm] :	-573.9842 SY.RBVAR_CUR_ -
Position Z [mm] :	358.3550 SY.RBVAR_CUR_ -
Posture RX [deg] :	-174.3759 SY.RBVAR_CUR_ -
Posture RY [deg] :	1.3117 SY.RBVAR_CUR_ -
Posture RZ [deg] :	90.2261 SY.RBVAR_CUR_ -
Posture type :	ZYX

Setting item	Setting value [Factory default]	Description
Scene ref number	-1 to 127 [-1: current scene]	Sets the scene number in which the HandEye Calibration is registered.
Unit ref number	-	Sets the processing unit number for the HandEye Calibration .
Robot type	-	The setting of the referenced HandEye Calibration processing item is displayed.
Robot posture	-	
Camera mount	-	
Robot mount	-	



Precautions for Correct Use

If the coordinate settings are not completed, you cannot set the items in tabs that follow this tab.

- If the warning message *Hand-Eye data is not set.* is displayed, review the reference settings in the **Hand-Eye data unit settings** area.

- 4 If **Camera mount** is set to *On hand camera*, set the items in the **Robot flange coord. seen from robot base coord** area.

Setting item	Setting value [Factory default]	Description
Position X [mm]	-10,000.0000 to 10,000.0000 [0.0000]	Set the position/posture of the flange in the robot base coordinate system when the input image was captured. If you set Posture type to <i>XYZ Euler angle</i> , RX is replaced with RZ .
Position Y [mm]	-10,000.0000 to 10,000.0000 [0.0000]	
Position Z [mm]	-10,000.0000 to 10,000.0000 [0.0000]	
Posture RX [deg] / Posture RZ [deg]	-180.0000 to 180.0000 [0.0000]	
Posture RY [deg]	-180.0000 to 180.0000 [0.0000]	
Posture RZ [deg]	-180.0000 to 180.0000 [0.0000]	
Posture type	-	



Precautions for Correct Use

If the coordinate settings are not completed, you cannot set the items in tabs that follow this tab.

- If the warning message *Flange coord. is invalid.* is displayed, review the set values.
If the evaluation values are all 0 or out of the setting range in the expression for position or posture, a warning message is displayed.
- If there is no calibration result data because hand-eye calibration has not been performed, the warning message *Hand-Eye data is not set.* is displayed.

5 In the **Display settings** area, you can change the image to display.

Setting item	Setting value [Factory default]	Description
Image kind	<ul style="list-style-type: none"> • [Input - Measure image 0] • Camera - Depth image • Camera - Captured (2D) • Camera - Captured (3D) 	Select the image to display in the Image display area. <ul style="list-style-type: none"> • Input - Measure image 0: The input image is displayed. If there are no processing items such as filters, Measurement image 0 from the Camera Image Input AOS processing item is displayed. • Camera - Depth image: The distance image from the Camera Image Input AOS processing item is displayed. • Camera - Captured (2D): The raw image (2D) from the Camera Image Input AOS processing item is displayed. If the 2D imaging settings are not enabled, the displayed image is completely black. • Camera - Captured (3D): The raw image (3D) from the Camera Image Input AOS processing item is displayed. If the 3D imaging settings are not enabled, the displayed image is completely black.

2-4-4 Pose of grasping (Grasp Planning)

Set the pose of grasping.

- 1** In the Item tab area, click the **Pose of grasping** tab.

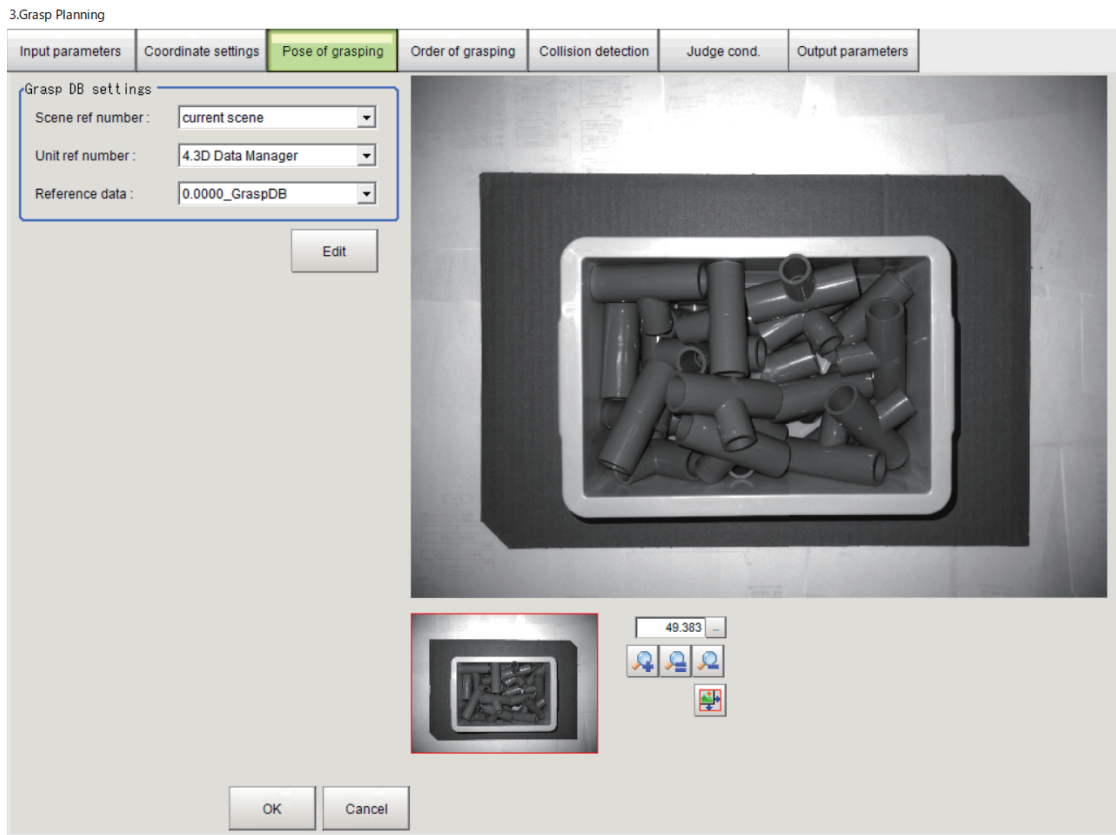

- 2** In the **Grasp DB settings** area, select the grasp pose data (grasp DB data) of the **3D Data Manager** processing item to reference.

Setting item	Setting value [Factory default]	Description
Scene ref number	-1 to 127 [-1: current scene]	Select the scene number of the scene that includes the 3D Data Manager processing item holding the grasp pose data (grasp DB data).
Unit ref number	-	From among the referenced scene numbers, select the 3D Data Manager processing item to reference.
Reference data	-	Select the grasp pose data (grasp DB data) of the referenced 3D Data Manager processing item. You can select only the grasp pose data (grasp DB data) created from the CAD data registered in the 3D Search processing item.

- 3** If necessary, you can click **Edit** to edit the grasp pose data (grasp DB data) set in **Reference data**.

The grasp registration tool **GraspTeachGUI** opens. Refer to 4-2-3 *Grasp DB (3D Data Manager)* on page 4-22 in the **3D Data Manager** processing item for the grasp registration tool **GraspTeachGUI**.

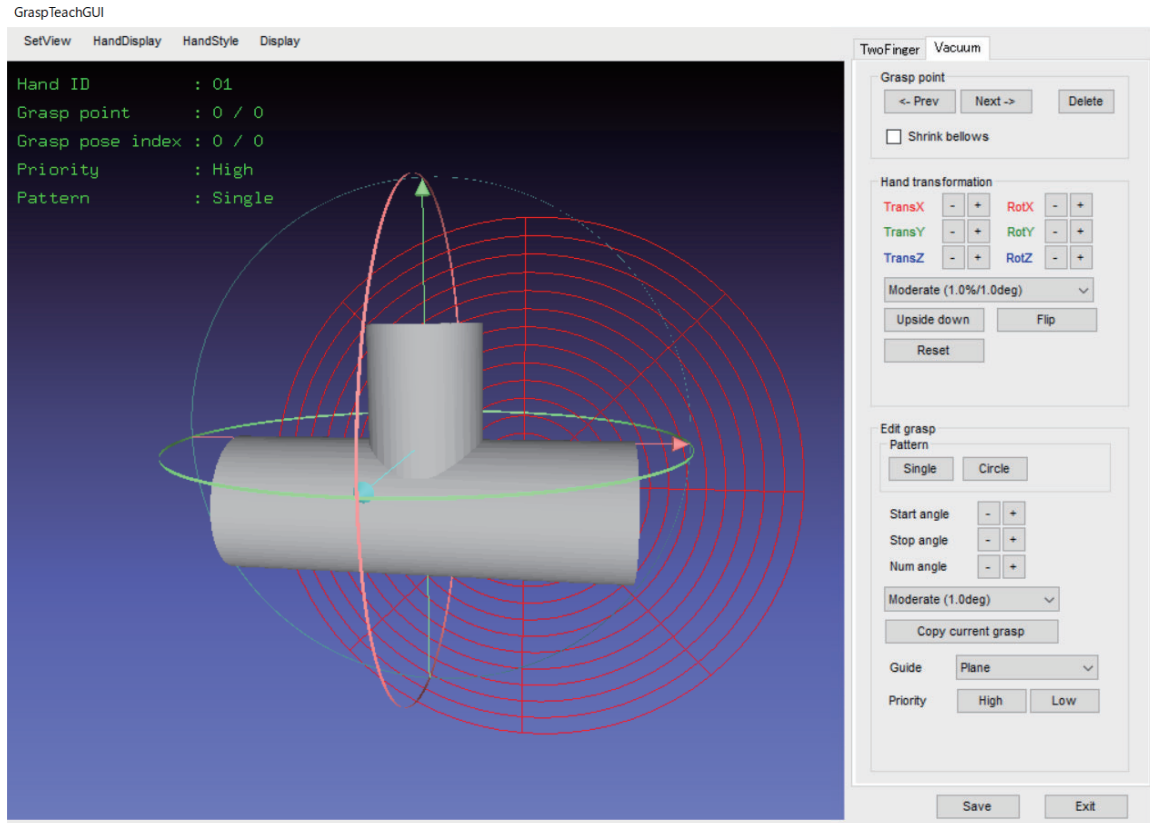

2-4-5 Order of grasping (Grasp Planning)

Determine the order of the graspable candidates.

Determine the Order of the Graspable Candidates

- 1** In the Item tab area, click the **Order of grasping** tab.

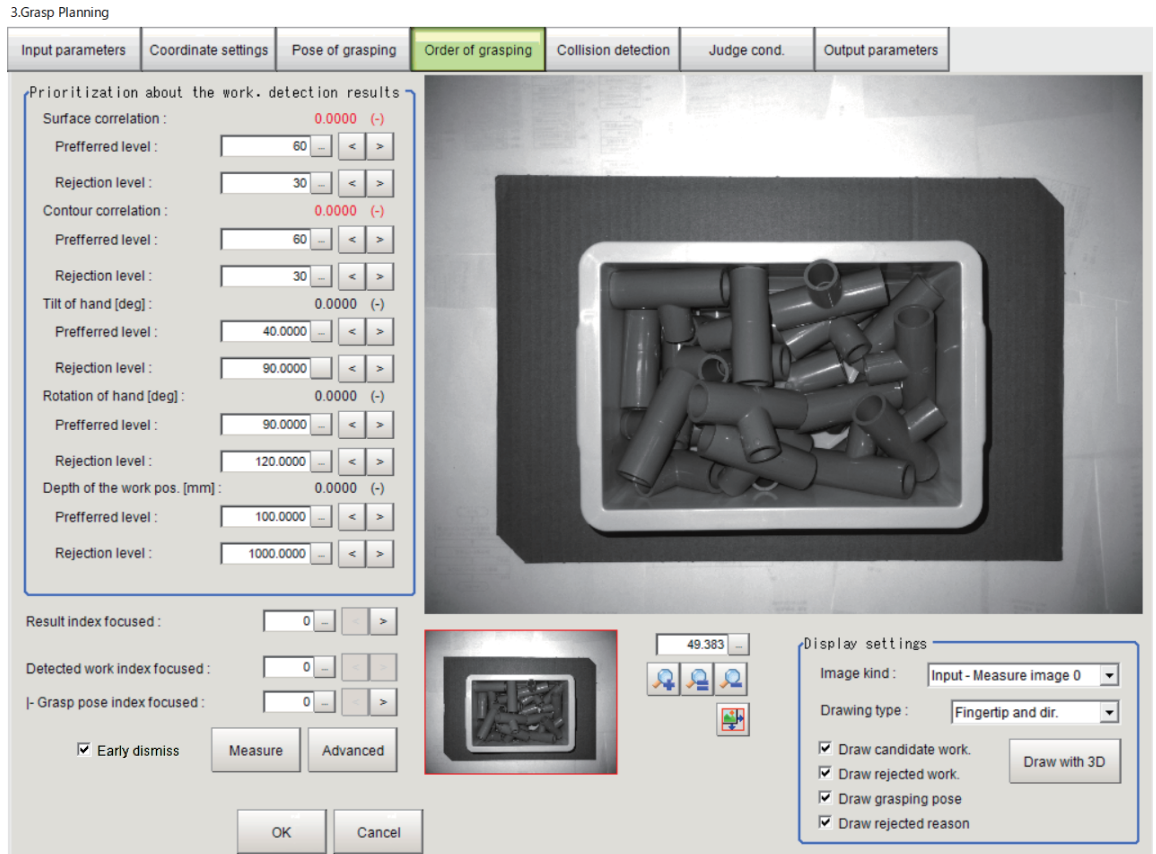

2 In the **Prioritization about the work. detection results** area, set the priority to determine the order of the graspable candidates.

Setting item	Setting value [Factory default]	Description
Surface correlation	-	The measurement values are displayed with the priority (rank A: A, rank B: B, rejection: -) shown in parentheses. Rank A: Surface correlation \geq Preferred level Rank B: Preferred level > Surface correlation > Rejection level Rejection: Surface correlation \leq Rejection level
Preferred level	0 to 100 [60]	
Rejection level	0 to 100 [30]	
Contour correlation	-	The measurement values are displayed with the priority (rank A: A, rank B: B, rejection: -) shown in parentheses. Rank A: Contour correlation \geq Preferred level Rank B: Preferred level > Contour correlation > Rejection level Rejection: Contour correlation \leq Rejection level
Preferred level	0 to 100 [60]	
Rejection level	0 to 100 [30]	
Tilt of hand [deg]	-	This is the tilt angle of the hand during grasping. The measurement values are displayed with the priority (rank A: A, rank B: B, rejection: -) shown in parentheses. Rank A: Tilt of hand \leq Preferred level Rank B: Preferred level < Tilt of the hand < Rejection level Rejection: Tilt of hand \geq Rejection Level
Preferred level	0.0000 to 180.0000 [40.0000]	
Rejection level	0.0000 to 180.0000 [90.0000]	

Setting item	Setting value [Factory default]	Description
Rotation of hand [deg]	-	<p>This is the amount of rotation of the flange during grasping. The measurement values are displayed with the priority (rank A: <i>A</i>, rank B: <i>B</i>, rejection: -) shown in parentheses.</p> <p>Rank A: Rotation of hand \leq Preferred level Rank B: Preferred level < Rotation of hand < Rejection level Rejection: Rotation of hand \geq Rejection level</p>
Preferred level	0.0000 to 180.0000 [90.0000]	
Rejection level	0.0000 to 180.0000 [120.0000]	
Depth of the work pos. [mm]	-	<p>This is the relative depth at the center of gravity of each workpiece.</p> <p>The measurement values are displayed with the priority (rank A: <i>A</i>, rank B: <i>B</i>, rejection: -) shown in parentheses.</p> <p>Rank A: Depth of the work pos. \leq Preferred level Rank B: Preferred level < Depth of the work pos. < Rejection level Rejection: Depth of work pos. \geq Rejection level</p>
Preferred level	0.0000 to 10,000.0000 [100.0000]	
Rejection level	0.0000 to 10,000.0000 [1,000.0000]	



Additional Information

- Tilt of hand

When the floor is set

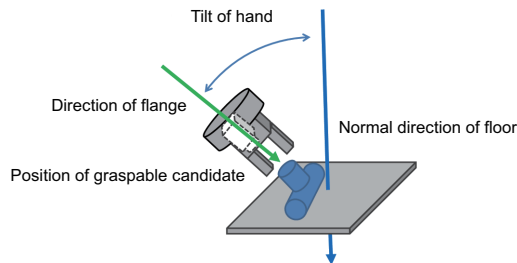

When the floor is not set

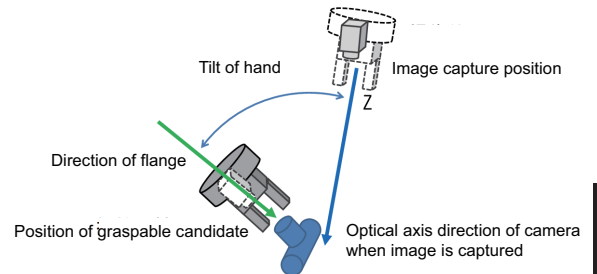

If the tilt of the hand is too large, there is a risk of a collision with the surrounding environment (such as equipment partitions) that are not the target of collision detection. In this case, set **Rejection level** under **Tilt of hand** to limit the detection range.

- Rotation of hand

The **Rotation of hand** is calculated as the angle between the **Ref. vector for hand rot (robot base coord)** and the **Ref. vector for hand rot (flange coord)**.

When the *X-axis positive direction* is set in the **Ref. vector for hand rot (robot base coord)** and the *X-axis negative direction* is set in the **Ref. vector for hand rot (flange coord)**.

XY plan view (robot base coord)

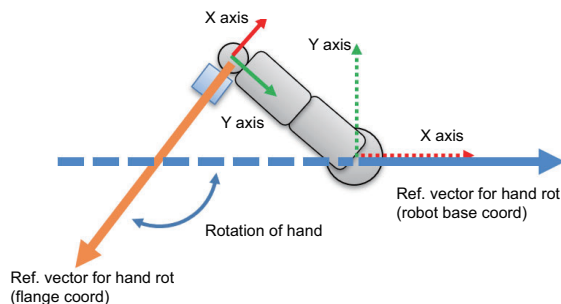

If the rotation amount of the hand is too large, there is a risk of wire breakage due to tangling of wire outside the machine. In this case, set **Rejection level** under **Rotation of hand** to limit the detection range.

Setting **Ref. vector for hand rot (flange coord)** to the direction in which the main work area (container) is located helps to limit the rotation range of the hand.

- Depth of the work pos.

When the floor is set

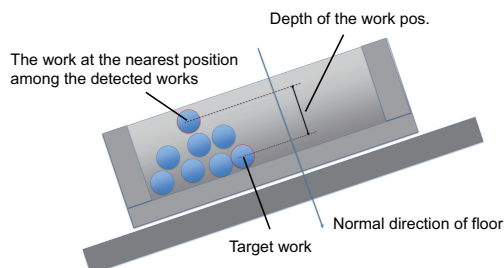

When the floor is not set

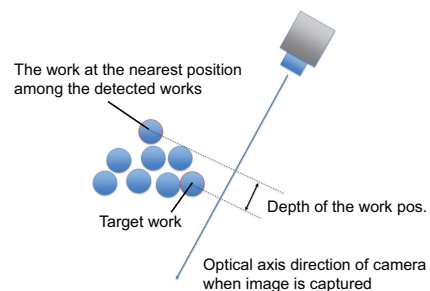

If the depth of the work position is too large, there is a risk that the robot hand will collide with other workpiece during picking operation. In this case, set **Rejection level** under **Depth of the work pos.** to limit the detection range.

- 3** Click **Advanced** to further set the following items.
Click **Return** to return to the previous menu.

Setting item	Setting value [Factory default]	Description
Treatment about a same priority one	<ul style="list-style-type: none"> • [Prioritize shallower pos. one] • Prioritize higher correlation one 	Set the priority used when there are more than one candidate with the same grasp priority (overall rank).
Ref. vector for hand rot (robot base coord)	<ul style="list-style-type: none"> • X-axis positive direction • X-axis negative direction • Y-axis positive direction • Y-axis negative direction • [Angle from X-axis positive] • Custom 	Set the reference vector in the robot base coordinate system when measuring the Tilt of hand .
Angle RZ [deg]	-180.0000 to 180.0000	Set this item only when Ref. vector for hand rot (robot base coord) is set to <i>Angle from X-axis positive</i> . Set the angle to set the reference vector.
Vector X	-1.0000 to 1.0000	Set this item only when Ref. vector for hand rot (robot base coord) is set to <i>Custom</i> . Set the reference vectors X, Y, and Z.
Vector Y	-1.0000 to 1.0000	
Vector Z	-1.0000 to 1.0000	

Setting item	Setting value [Factory default]	Description
Ref. vector for hand rot (flange coord)	<ul style="list-style-type: none"> • X-axis positive direction • X-axis negative direction • Y-axis positive direction • Y-axis negative direction • Angle from X-axis positive • Custom • [Y-axis negative direction (camera coord)] • Current posture 	Set the reference vector in the flange coordinate system when measuring the Tilt of hand .
Angle RZ [deg]	-180.0000 to 180.0000	Set this item only when Ref. vector for hand rot (flange coord) is set to <i>Angle from X-axis positive</i> . Set the angle to set the reference vector.
Vector X	-1.0000 to 1.0000	Set this item only when Ref. vector for hand rot (flange coord) is set to <i>Custom</i> . Set the reference vectors X, Y, and Z.
Vector Y	-1.0000 to 1.0000	
Vector Z	-1.0000 to 1.0000	



Additional Information

Setting **Ref. vector for hand rot (flange coord)** to the direction in which the main work area (container) is located helps to limit the rotation range of the hand.

Basically, you can leave the **Ref. vector for hand rot (flange coord)** setting as *Y-axis negative direction (camera coord)*, which is the mounting direction of the 3D vision sensor.

For **Ref. vector for hand rot (robot base coord)**, set a vector with the same direction as **Ref. vector for hand rot (flange coord)**.

Ref. vector for hand rot (robot base coord)

XY plan view (robot base coord)

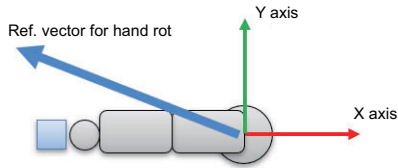

XZ plan view (robot base coord)

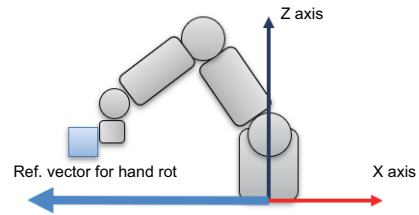

- When set to *X-axis positive direction*

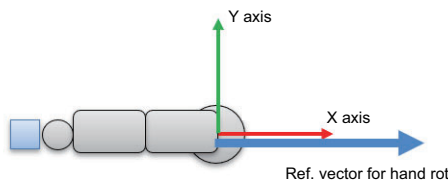

- When set to *X-axis negative direction*

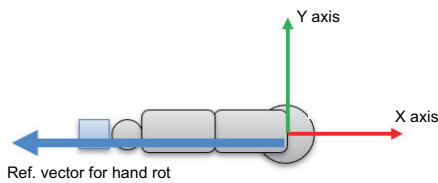

- When set to *Y-axis positive direction*

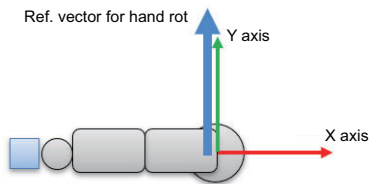

- When set to *Y-axis negative direction*

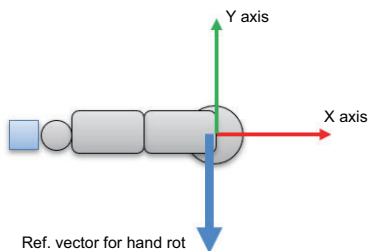

- When set to *Angle from X-axis positive*

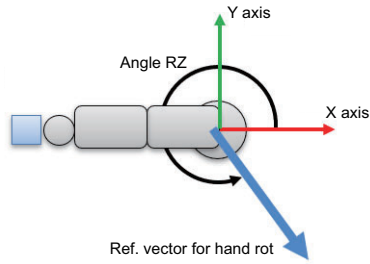

- When set to *Custom*

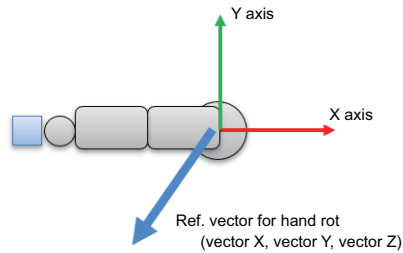

Ref. vector for hand rot (flange coord)

XY plan view (robot base coord)

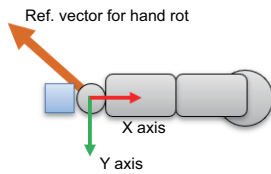

XZ plan view (robot base coord)

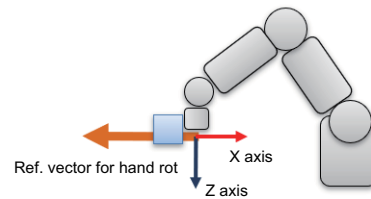

- When set to *X-axis positive direction*

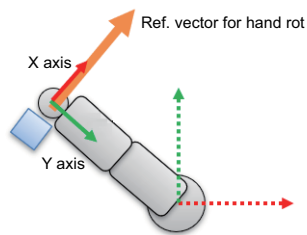

- When set to *X-axis negative direction*

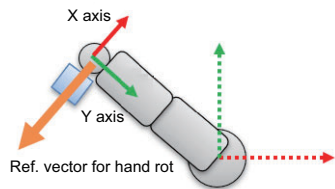

- When set to *Y-axis positive direction*

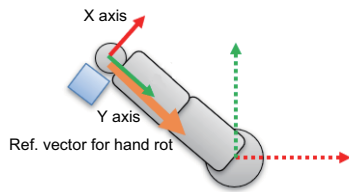

- When set to *Y-axis negative direction*

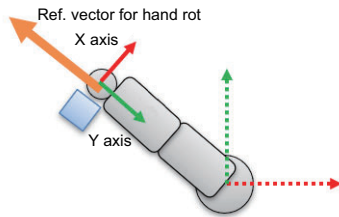

- When set to *Angle from X-axis positive*

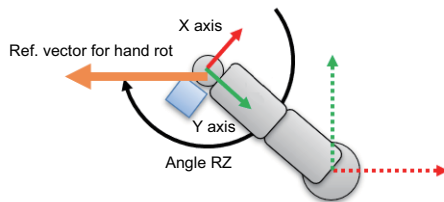

- When set to *Custom*

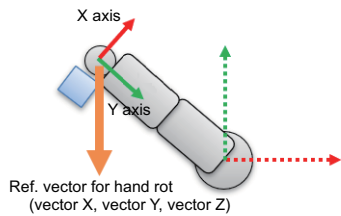

- When set to *Y-axis negative direction (camera coord)*

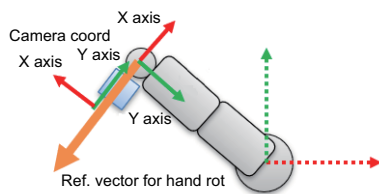

- When set to *Current posture*

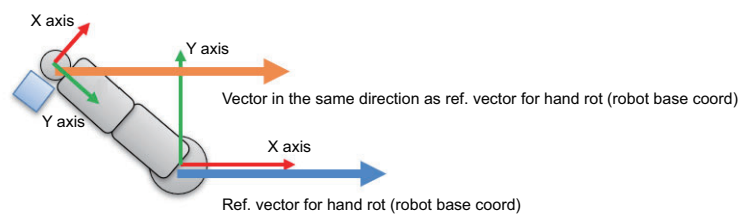

4 Click **Measure**.

A test measurement is performed according to the set values.

Setting item	Setting value [Factory default]	Description
Result index focused	0 to 1,023 [0]	Switch the displayed graspable candidate.
Detected work index focused	0 to Detected workpiece count	Set this item only when Draw rejected reason is checked. Switch the detected workpieces for which to display the rejection reason.
Grasp pose index focused	0 to Registered grasp pose count	Set this item only when Draw rejected reason is checked. Switch the target pose of grasping to display the rejection reason. It corresponds to the grasp pose data (grasp DB data) of the 3D Data Manager processing item referenced in the Pose of grasping tab.
Early dismiss	[Checked] Unchecked	Checked: Early dismissal is performed similar to the actual measurement processing. The hand condition at the interfering grasp pose is not drawn. Unchecked: Early dismissal is not performed during test measurement in the processing items. The hand condition at the interfering grasp pose is also drawn.

Checking Measurement Results in the Image (Display Settings)

You can change the display settings to check the processing conditions for measurements on the image.

- 1 Set the value in the **Display settings** area.

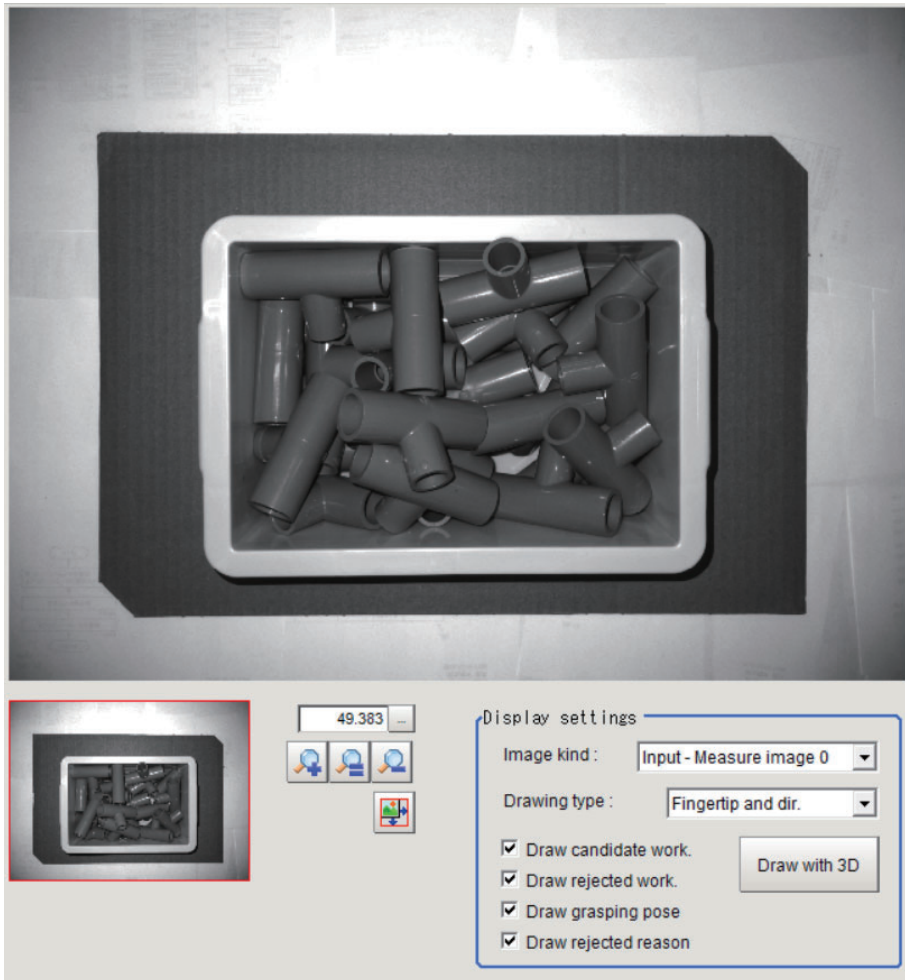

Setting item	Setting value [Factory default]	Description
Image kind	<ul style="list-style-type: none"> • [Input - Measure image 0] • Camera - Depth image • Camera - Captured (2D) • Camera - Captured (3D) 	<p>Select the image to display in the Image display area.</p> <ul style="list-style-type: none"> • Input - Measure image 0: The input image is displayed. If there are no processing items such as filters, Measurement image 0 from the Camera Image Input AOS processing item is displayed. • Camera - Depth image: The distance image from the Camera Image Input AOS processing item is displayed. • Camera - Captured (2D): The raw image (2D) from the Camera Image Input AOS processing item is displayed. If the 2D imaging settings are not enabled, the displayed image is completely black. • Camera - Captured (3D): The raw image (3D) from the Camera Image Input AOS processing item is displayed. If the 3D imaging settings are not enabled, the displayed image is completely black.

Setting item	Setting value [Factory default]	Description
Drawing type	<ul style="list-style-type: none"> Fingertip [Fingertip and dir.] Finger wire frame Overall wire frame 	<ul style="list-style-type: none"> Fingertip: The wire frame of the parts corresponding to the Left tip finger, Right tip finger and, Pad set in the hand data is displayed. Fingertip and dir.: The wire frame of the parts corresponding to the Left tip finger, Right tip finger and, Pad set in the hand data is displayed. A straight line that indicates the approach direction for grasping is displayed. Finger wire frame: The wire frame of the parts corresponding to the Left finger, Left tip finger, Right finger, Right tip finger, Pad, and Bellows set in the hand data is displayed. Overall wire frame: The wire frame of all parts in the hand data is displayed. <p>For the hand data, refer to <i>4-2-2 Hand Data (3D Data Manager)</i> on page 4-6.</p>
Draw candidate work.	<ul style="list-style-type: none"> [Checked] Unchecked 	<p>Check this to display the contour of the next candidate workpiece. It is displayed in the color corresponding to the judgment result of the 3D Search. (If both thresholds are exceeded, it will be displayed in green. If either threshold is exceeded, it will be displayed in red.)</p> <p>The Detected work index focused (W) and Grasp pose index focused (G) are displayed in green text.</p>
Draw rejected work.	<ul style="list-style-type: none"> [Checked] Unchecked 	<p>Check this to display the contour of the rejected graspable candidate workpieces in purple.</p>
Draw grasping pose	<ul style="list-style-type: none"> [Checked] Unchecked 	<p>Check this to display the graspable candidate hand in white.</p>

Setting item	Setting value [Factory default]	Description
Draw rejected reason	<ul style="list-style-type: none"> • [Checked] • Unchecked 	<p>Check this to display the rejection reason for the graspable candidate. The rejection reason is displayed in green text for the graspable candidate and in red text for rejected graspable candidates.</p> <p>The display items for the rejection reason are as follows.</p> <ul style="list-style-type: none"> • Bad correlation or depth of workpiece The candidate was rejected due to a problem with the 3D Search correlation values or the workpiece depth. • Bad tilt of hand The candidate was rejected due to a problem with the tilt of the hand during grasping. • Bad rotation of hand The candidate was rejected due to a problem with the rotation amount of the hand during grasping. • Not the best one The candidate was rejected because it is not the best candidate among the automatically registered poses of grasping during registration in a circular pattern. • Collision with the floor The candidate was rejected due to a collision between the floor and the hand during grasping. • Collision with the container The candidate was rejected due to a collision between the container and the hand during grasping. • Collision with the point cloud The candidate was rejected due to a collision between a measurement point cloud and the hand during grasping. • Collision with the workpiece The candidate was rejected due to a collision between the recognized workpiece and the hand during grasping. • Early termination The candidate was rejected because it is not a search target that meets the early termination conditions for search. • No problem Graspable
Draw with 3D	-	<p>Click this to start the 3D result display tool FZ-3DVisualizer. Use the 3D result display tool FZ-3DVisualizer to display the results in 3D.</p> <p><i>Checking 3D Measurement Results (FZ-3DVisualizer) on page 2-102</i></p>

2 Check the status of the measurement processing on the image, and set the order of grasping.

● Checking 3D Measurement Results (FZ-3DVisualizer)

FZ-3DVisualizer is a result display tool that draws 3D point clouds, recognized workpieces, recognized pose of grasping, etc. in 3D space. Use this tool to check the detection results for the **3D Search** and **Grasp Planning** processing items to see if objects are detected in appropriate positions in 3D space.

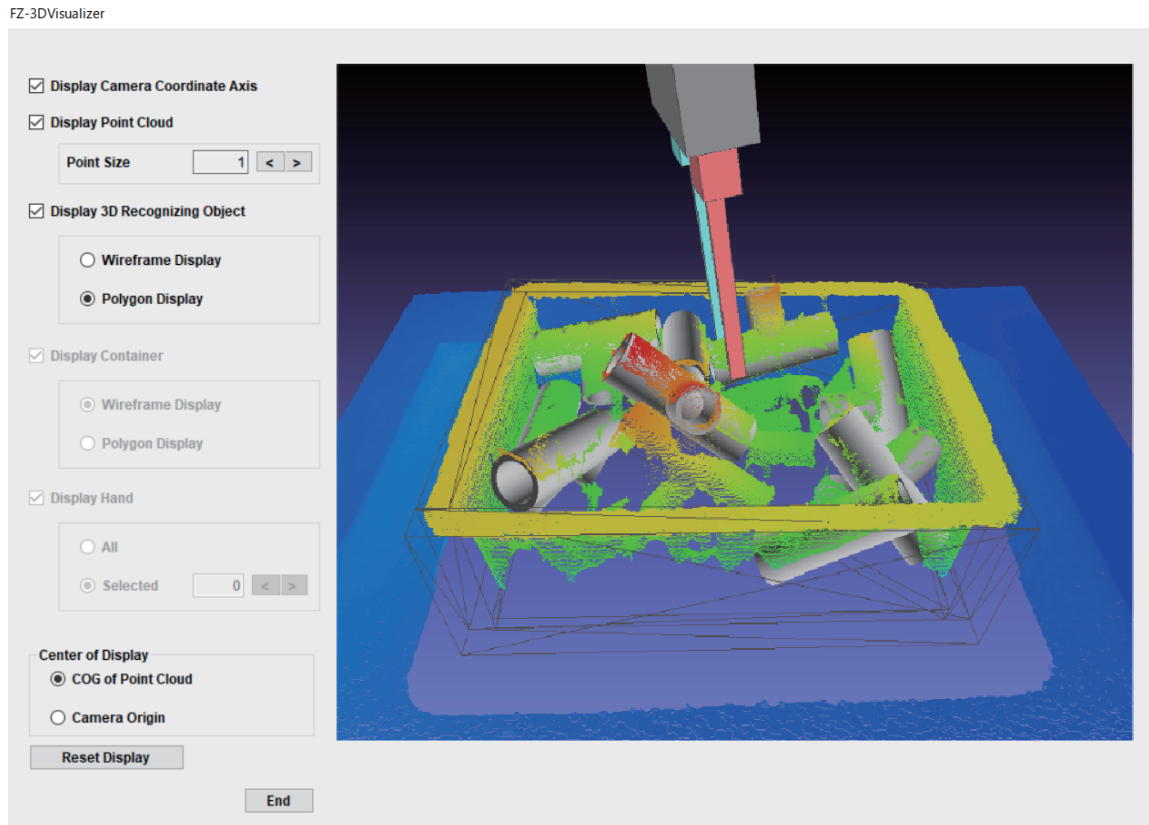

3D objects are displayed in the image display area.

Operation	Description
Left-click + Drag	You can move the viewpoint by rotating the image around the display center of the image display area.
Mouse wheel scroll	You can zoom in and out the image around the display center of the image display area.
Middle click + Drag or Shift key + Left-click + Drag	You can move the display center of the image display area.

Item	Description
Display Camera Coordinate Axis	Show or hide the camera coordinate axes.
Display Point Cloud	Show or hide the point cloud data.
Point Size	Change the size of the displayed point cloud. The point cloud size range is 1 to 5.
Display 3D Recognizing Object	Show or hide the workpiece recognized in the 3D Search processing item.
Wireframe Display	Set the workpiece display format to wireframe display.
Polygon Display	Set the workpiece display format to polygon display.
Display Container	Show or hide the container detected in the Container Detection processing item. It cannot be set in the 3D Search processing item.
Wireframe Display	Set the workpiece display format to wireframe display.
Polygon Display	Set the workpiece display format to polygon display.

Item	Description
Display Hand	Show or hide the pose of grasping calculated in the Grasp Planning processing item. It cannot be set in the 3D Search processing item.
All	All candidates are displayed at the same time.
Selected	One of the candidates for the specified measurement result number is displayed.
Center of Display	Switch the display center of the image display area between the center of gravity of the point cloud (center of gravity XYZ of the point cloud data) and the camera origin.
COG of Point Cloud	
Camera Origin	
Reset Display	Reset the display position of the image display area to the initial position.
End	Close the FZ-3DVisualizer tool.

2-4-6 Collision detection (Grasp Planning)

Perform a collision detection.

- Determine whether the hand collides with the surrounding environment with a known shape and placement.

Collision between the hand model and the 3D container model and the floor

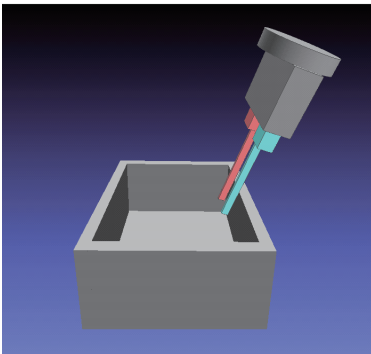

- Determine whether the hand collides with measured objects (point clouds).

Collision between the hand model and measured 3D point clouds

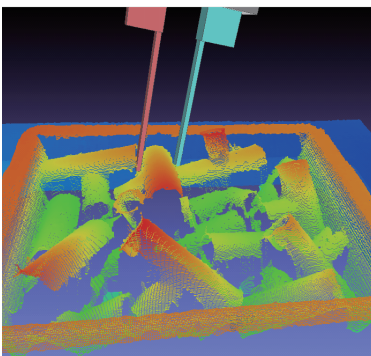

- Determine whether the hand collides with the detected workpiece.

Collision between the hand model and the workpiece (CAD model superimposed on the detection position)

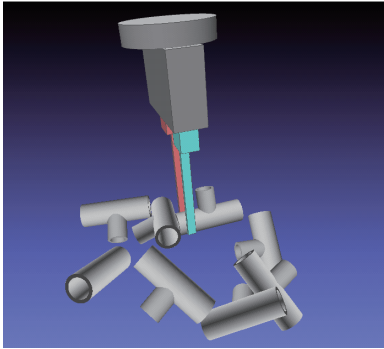

Performing Collision Detection

- 1 In the Item tab area, click the **Collision detection** tab.

3.Grasp Planning

- 2 In the **Collision with hand** area, set the margin for collision detection.

Setting item	Setting value [Factory default]	Description
Margin [mm]	0.0000 to 10,000.0000 [0.0000]	Set the margin for detecting a collision with the hand. This margin is applied to the hand model during collision detection. If the set margin is too large, grasp candidates may not be detected.

- 3** In the **Collision with the surrounding environment** area, set the surrounding environment with which to detect collisions.

Setting item	Setting value [Factory default]	Description
Target object	<ul style="list-style-type: none"> • [None] • Floor • Container • Container + Floor 	<ul style="list-style-type: none"> • None: No collisions with the surrounding environment are detected. • Floor: Collisions with the floor are detected. • Container: Collisions with the container are detected. • Container + Floor: Collisions with the container and floor are detected.
Scene ref number	-1 to 127 [-1: current scene]	Set the scene number in which the Container Detection is registered.
Unit ref number	-	Set the processing unit number for the Container Detection .
Margin [mm]	0.0000 to 10,000.0000 [0.0000]	Set the margin for detecting a collision with the surrounding environment (floor and container). This margin is applied to the surrounding environment (floor and container) during collision detection to judge whether there are collisions. If the set margin is too large, grasp candidates may not be detected.

- 4** In the **Collision with point cloud** area, set the collision points for collision detection.

Setting item	Setting value [Factory default]	Description
Outlier Height [mm]	10.0000 to 10,000.0000 [150.0000]	Set the threshold for regarding point clouds at the specified height or above from the floor as outliers. Outlier point clouds are not used for collision detection.
Tolerance [point]	0 to 1,000 [20]	Set the number of point clouds for which collisions with the hand are allowed. Note that this setting is intended to absorb noise in measurement point clouds. If the set tolerance value is too large, collision detection may not work properly for point clouds.
Collision point count	-	The number of collision points with the hand and point clouds is displayed for the graspable candidate specified in Result index focused .

- 5** Click **Measure**.

A test measurement is performed according to the set values.

The result of the collision detection is displayed in the **Collision status** area.

Setting item	Setting value [Factory default]	Description
Collision	-	The collision status of the candidate specified in Detected work index focused and Result index focused is displayed.

Setting item	Setting value [Factory default]	Description
Result index focused	0 to 1,023 [0]	Switch the displayed graspable candidate.

Setting item	Setting value [Factory default]	Description
Detected work index focused	0 to Detected workpiece count	Switch the detected workpiece for which to display the collision status.
Grasp pose index focused	0 to Registered grasp pose count	Switch the pose of grasping of the target for which to display the collision status. It corresponds to the grasp pose data (grasp DB data) of the 3D Data Manager processing item referenced in the Pose of grasping tab.
Early dismiss	[Checked] Unchecked	Checked: Early dismissal is performed similar to the actual measurement processing. The hand condition at the interfering grasp pose is not drawn. Unchecked: Early dismissal is not performed during test measurement in the processing items. The hand condition at the interfering grasp pose is also drawn.

Checking Measurement Results in the Image (Display Settings)

You can change the display settings to check the processing conditions for measurements on the image.

- 1 Set the value in the **Display settings** area.

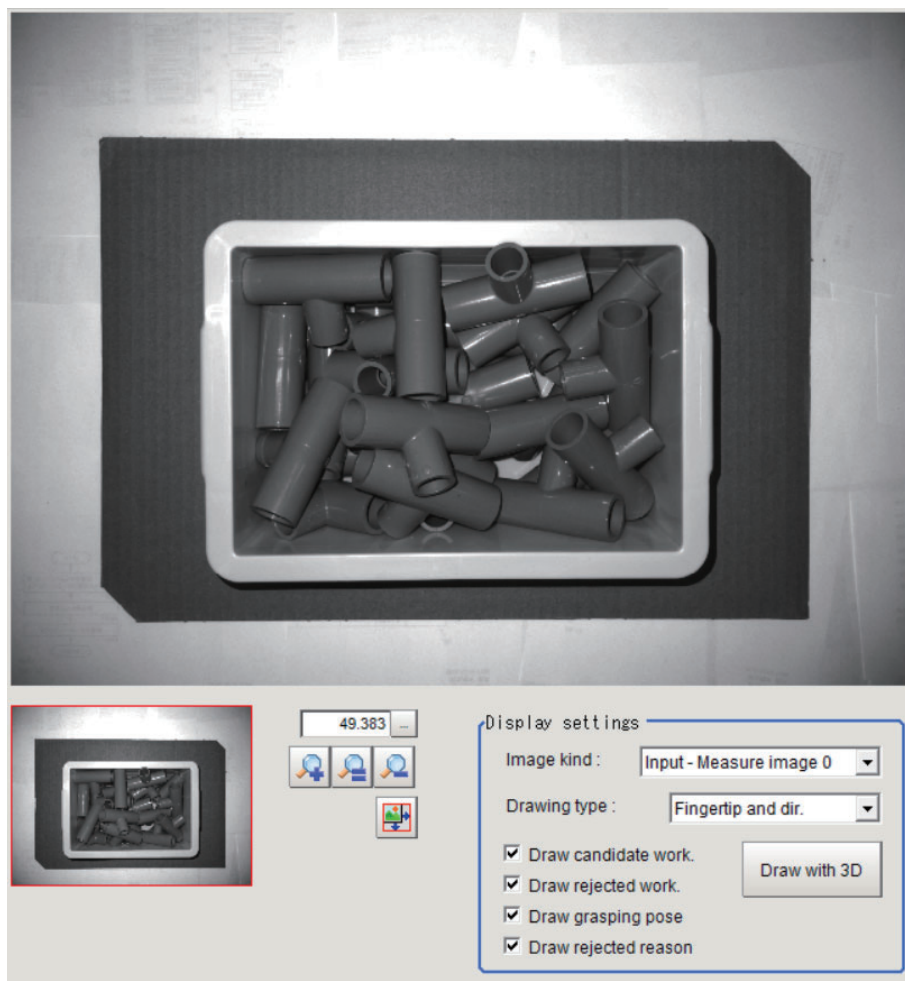

Setting item	Setting value [Factory default]	Description
Image kind	<ul style="list-style-type: none"> • [Input - Measure image 0] • Camera - Depth image • Camera - Captured (2D) • Camera - Captured (3D) 	<p>Select the image to display in the Image display area.</p> <ul style="list-style-type: none"> • Input - Measure image 0: The input image is displayed. If there are no processing items such as filters, Measurement image 0 from the Camera Image Input AOS processing item is displayed. • Camera - Depth image: The distance image from the Camera Image Input AOS processing item is displayed. • Camera - Captured (2D): The raw image (2D) from the Camera Image Input AOS processing item is displayed. If the 2D imaging settings are not enabled, the displayed image is completely black. • Camera - Captured (3D): The raw image (3D) from the Camera Image Input AOS processing item is displayed. If the 3D imaging settings are not enabled, the displayed image is completely black.
Drawing type	<ul style="list-style-type: none"> • Fingertip • [Fingertip and dir.] • Finger wire frame • Overall wire frame 	<ul style="list-style-type: none"> • Fingertip: The wire frame of the parts corresponding to the Left tip finger, Right tip finger and, Pad set in the hand data is displayed. • Fingertip and dir.: The wire frame of the parts corresponding to the Left tip finger, Right tip finger and, Pad set in the hand data is displayed. A straight line that indicates the approach direction for grasping is displayed. • Finger wire frame: The wire frame of the parts corresponding to the Left finger, Left tip finger, Right finger, Right tip finger, Pad, and Bellows set in the hand data is displayed. • Overall wire frame: The wire frame of all parts in the hand data is displayed. <p>For the hand data, refer to <i>4-2-2 Hand Data (3D Data Manager)</i> on page 4-6.</p>
Draw candidate work.	<ul style="list-style-type: none"> • [Checked] • Unchecked 	<p>Check this to display the contour of the next candidate workpiece. It is displayed in the color corresponding to the judgment result of the 3D Search. (If both thresholds are exceeded, it will be displayed in green. If either threshold is exceeded, it will be displayed in red.)</p> <p>The Detected work index focused (W) and Grasp pose index focused (G) are displayed in green text.</p>
Draw rejected work.	<ul style="list-style-type: none"> • [Checked] • Unchecked 	<p>Check this to display the contour of the rejected graspable candidate workpieces in purple.</p>
Draw grasping pose	<ul style="list-style-type: none"> • [Checked] • Unchecked 	<p>Check this to display the graspable candidate hand in white.</p>

Setting item	Setting value [Factory default]	Description
Draw rejected reason	<ul style="list-style-type: none"> • [Checked] • Unchecked 	<p>Check this to display the rejection reason for the graspable candidate. The rejection reason is displayed in green text for the graspable candidate and in red text for rejected graspable candidates.</p> <p>The display items for the rejection reason are as follows.</p> <ul style="list-style-type: none"> • Bad correlation or depth of workpiece The candidate was rejected due to a problem with the 3D Search correlation values or the workpiece depth. • Bad tilt of hand The candidate was rejected due to a problem with the tilt of the hand during grasping. • Bad rotation of hand The candidate was rejected due to a problem with the rotation amount of the hand during grasping. • Not the best one The candidate was rejected because it is not the best candidate among the automatically registered poses of grasping during registration in a circular pattern. • Collision with the floor The candidate was rejected due to a collision between the floor and the hand during grasping. • Collision with the container The candidate was rejected due to a collision between the container and the hand during grasping. • Collision with the point cloud The candidate was rejected due to a collision between a measurement point cloud and the hand during grasping. • Collision with the workpiece The candidate was rejected due to a collision between the recognized workpiece and the hand during grasping. • Early termination The candidate was rejected because it is not a search target that meets the early termination conditions for search. • No problem Graspable
Draw with 3D	-	<p>Click this to start the 3D result display tool FZ-3DVisualizer. Use the 3D result display tool FZ-3DVisualizer to display the results in 3D.</p> <p><i>Checking 3D Measurement Results (FZ-3DVisualizer) on page 2-102</i></p>

2 Check the status of the measurement processing on the image, and set the order of grasping.

2-4-7 Judge cond. (Grasp Planning)

Set the judgment conditions for the measurement results.

Set the upper and lower values to judge the measurement result. When the measurement result value is within the upper and lower values, Judgment is OK (pass). When the measurement result value exceeds either the upper or lower value Judgment is NG (failure). Although the judgment result for the processing Unit is OK when the judgment for all measurements is OK, it will be NG if any measurement result is NG.

1 In the Item tab area, click **Judge cond.**

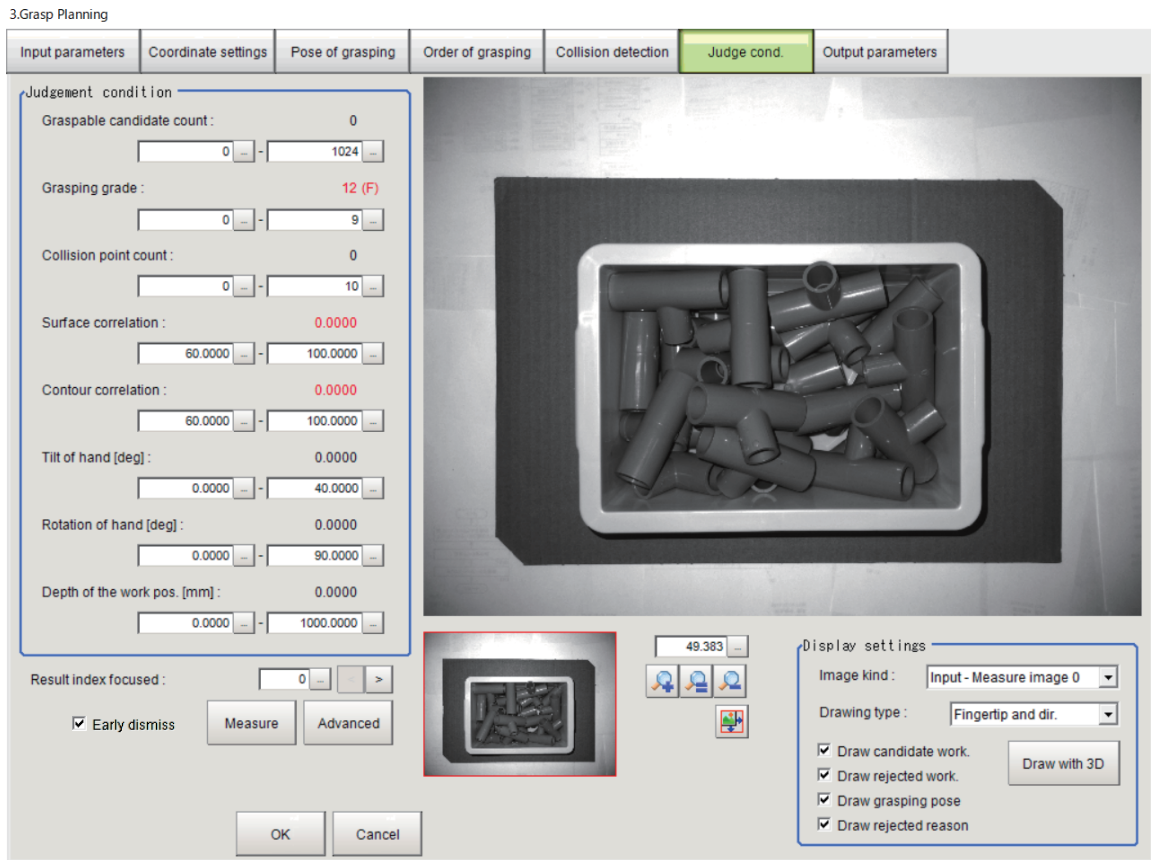

2 Set the value in the **Judgement condition** area.

The values of the graspable candidate set in the **Result index focused** are displayed. The values of NG items are displayed in red.

Setting item	Setting value [Factory default]	Description
Graspable candidate count	0 to 1,024 [0] to [1,024]	Set the upper and lower limits of the graspable candidate count to judge as OK.
Grasping grade	0 to 12 [0] to [9]	Set the upper and lower limits of the grasping grade to judge as OK. The grasping grade is an overall index for the priority of the graspable candidate specified in Result index focused . The smaller the number (closer to A), the higher the grasping grade. 0: A, 1: B1, 2: B2, 3: B3, 4: B4, 5: B5, 6: C1, 7: C2, 8: C3, 9: C4, 10: C5, 11: C6, 12: F
Collision point count	0 to 10,000 [0] to [10]	Set the upper and lower limits of the collision point count to judge as OK.
Surface correlation	0.0000 to 100.0000 [60.0000] to [100.0000]	Set the upper and lower limits of the surface correlation value to judge as OK.

Setting item	Setting value [Factory default]	Description
Contour correlation	0.0000 to 100.0000 [60.0000] to [100.0000]	Set the upper and lower limits of the contour correlation value to judge as OK.
Tilt of hand [deg]	0.0000 to 180.0000 [0.0000] to [40.0000]	Set the upper and lower limits of the tilt angle of the hand to judge as OK.
Rotation of hand [deg]	0.0000 to 180.0000 [0.0000] to [90.0000]	Set the upper and lower limits of the amount of rotation of the hand to judge as OK.
Depth of the work pos. [mm]	0.0000 to 10,000.0000 [0.0000] to [1,000.0000]	Set the upper and lower limits of the depth of the workpiece position to judge as OK.

- 3** Click **Advanced**. Set the value in the **Judgement condition** area.
Click **Return** to return to the previous menu.

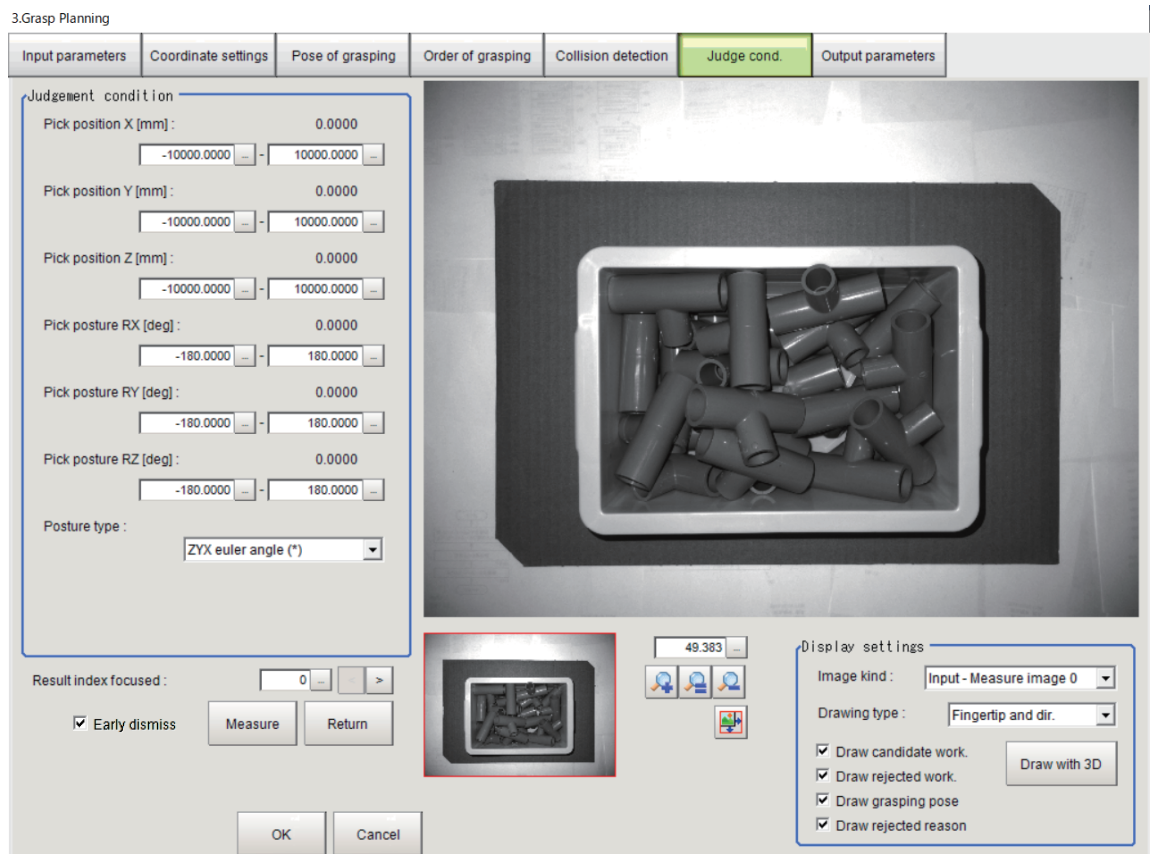

Setting item	Setting value [Factory default]	Description
Pick position X [mm]	[-10,000.0000] to [10,000.0000]	The position of the flange during picking (in the robot coordinate system). Set the range of coordinates to judge as OK.
Pick position Y [mm]	[-10,000.0000] to [10,000.0000]	
Pick position Z [mm]	[-10,000.0000] to [10,000.0000]	
Pick posture RX [deg] / Pick posture RZ [deg]	[-180] to [180]	The posture of the flange during picking (in the robot coordinate system). Set the range of angles to judge as OK. If you set Posture type to <i>ZYZ Euler angle</i> , RX is replaced with RZ .
Pick posture RY [deg]	[-180] to [180]	
Pick posture RZ [deg]	[-180] to [180]	
Posture type	<ul style="list-style-type: none"> • [ZYX Euler angle] • ZYZ Euler angle • XYZ Euler angle 	Set the posture angle type to use for judgment. The setting of the referenced HandEye calibration data in Coordinate settings is indicated with (*).

- 4** When the setting has been changed, click **Measure** to verify whether measurement can be performed correctly.

Setting item	Setting value [Factory default]	Description
Result index focused	0 to 1,023 [0]	Switch the displayed graspable candidate.
Early dismiss	[Checked] Unchecked	Checked: Early dismissal is performed similar to the actual measurement processing. The hand condition at the interfering grasp pose is not drawn. Unchecked: Early dismissal is not performed during test measurement in the processing items. The hand condition at the interfering grasp pose is also drawn.

Checking Measurement Results in the Image (Display Settings)

You can change the display settings to check the processing conditions for measurements on the image.

- 1** Set the value in the **Display settings** area.

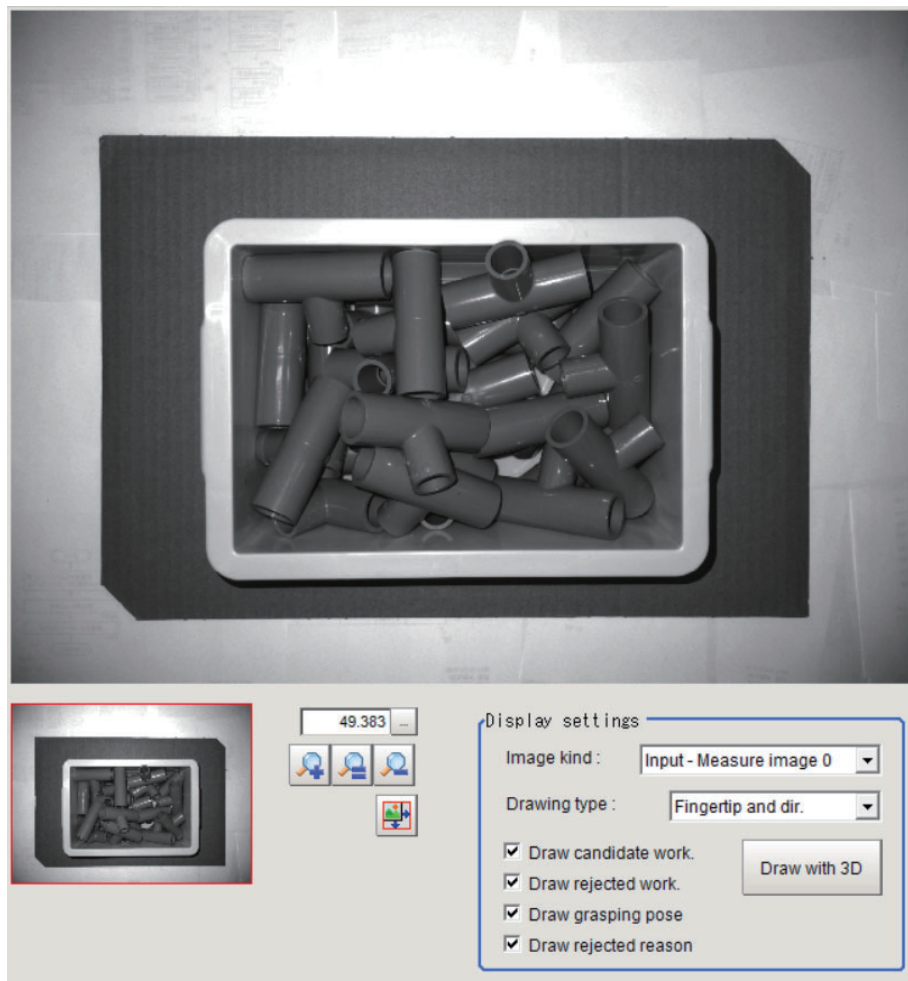

Setting item	Setting value [Factory default]	Description
Image kind	<ul style="list-style-type: none"> [Input - Measure image 0] Camera - Depth image Camera - Captured (2D) Camera - Captured (3D) 	<p>Select the image to display in the Image display area.</p> <ul style="list-style-type: none"> Input - Measure image 0: The input image is displayed. If there are no processing items such as filters, Measurement image 0 from the Camera Image Input AOS processing item is displayed. Camera - Depth image: The distance image from the Camera Image Input AOS processing item is displayed. Camera - Captured (2D): The raw image (2D) from the Camera Image Input AOS processing item is displayed. If the 2D imaging settings are not enabled, the displayed image is completely black. Camera - Captured (3D): The raw image (3D) from the Camera Image Input AOS processing item is displayed. If the 3D imaging settings are not enabled, the displayed image is completely black.

Setting item	Setting value [Factory default]	Description
Drawing type	<ul style="list-style-type: none"> Fingertip [Fingertip and dir.] Finger wire frame Overall wire frame 	<ul style="list-style-type: none"> Fingertip: The wire frame of the parts corresponding to the Left tip finger, Right tip finger and, Pad set in the hand data is displayed. Fingertip and dir.: The wire frame of the parts corresponding to the Left tip finger, Right tip finger and, Pad set in the hand data is displayed. A straight line that indicates the approach direction for grasping is displayed. Finger wire frame: The wire frame of the parts corresponding to the Left finger, Left tip finger, Right finger, Right tip finger, Pad, and Bellows set in the hand data is displayed. Overall wire frame: The wire frame of all parts in the hand data is displayed. <p>For the hand data, refer to <i>4-2-2 Hand Data (3D Data Manager)</i> on page 4-6.</p>
Draw candidate work.	<ul style="list-style-type: none"> [Checked] Unchecked 	<p>Check this to display the contour of the next candidate workpiece. It is displayed in the color corresponding to the judgment result of the 3D Search. (If both thresholds are exceeded, it will be displayed in green. If either threshold is exceeded, it will be displayed in red.)</p> <p>The Detected work index focused (W) and Grasp pose index focused (G) are displayed in green text.</p>
Draw rejected work.	<ul style="list-style-type: none"> [Checked] Unchecked 	<p>Check this to display the contour of the rejected graspable candidate workpieces in purple.</p>
Draw grasping pose	<ul style="list-style-type: none"> [Checked] Unchecked 	<p>Check this to display the graspable candidate hand in white.</p>

Setting item	Setting value [Factory default]	Description
Draw rejected reason	<ul style="list-style-type: none"> • [Checked] • Unchecked 	<p>Check this to display the rejection reason for the graspable candidate. The rejection reason is displayed in green text for the graspable candidate and in red text for rejected graspable candidates.</p> <p>The display items for the rejection reason are as follows.</p> <ul style="list-style-type: none"> • Bad correlation or depth of workpiece The candidate was rejected due to a problem with the 3D Search correlation values or the workpiece depth. • Bad tilt of hand The candidate was rejected due to a problem with the tilt of the hand during grasping. • Bad rotation of hand The candidate was rejected due to a problem with the rotation amount of the hand during grasping. • Not the best one The candidate was rejected because it is not the best candidate among the automatically registered poses of grasping during registration in a circular pattern. • Collision with the floor The candidate was rejected due to a collision between the floor and the hand during grasping. • Collision with the container The candidate was rejected due to a collision between the container and the hand during grasping. • Collision with the point cloud The candidate was rejected due to a collision between a measurement point cloud and the hand during grasping. • Collision with the workpiece The candidate was rejected due to a collision between the recognized workpiece and the hand during grasping. • Early termination The candidate was rejected because it is not a search target that meets the early termination conditions for search. • No problem Graspable
Draw with 3D	-	<p>Click this to start the 3D result display tool FZ-3DVisualizer. Use the 3D result display tool FZ-3DVisualizer to display the results in 3D.</p> <p><i>Checking 3D Measurement Results (FZ-3DVisualizer) on page 2-102</i></p>

2 Check the status of the measurement processing on the image, and set the order of grasping.

2-4-8 Output Parameters (Grasp Planning)

Select how to handle the coordinates to be output to the external device as measurement results. This item can be changed as necessary. Normally, the factory default value will be used.

1 In the Item tab area, click **Output parameter**.

2 Select the *Reflect to overall judgment*.

Setting item	Setting value [Factory default]	Description
Reflect to overall judgment	<ul style="list-style-type: none"> • [ON] • OFF 	-

2-4-9 Key Points for Test Measurement and Adjustment (Grasp Planning)

The following content is displayed in the *Detail result* area as text.



Precautions for Correct Use

Executing test measurements will also update the measurement results and the figures in the image.

Displayed item	Description
Judge	Judgment result 0: No judgment (unmeasured) 1: Judgment result OK -1: Judgment result NG -10: Error (image format mismatch) -11: Error (unregistered model) -12: Error (insufficient memory) -20: Error (other errors)
Graspable candidate count	Number of graspable candidates detected
Grasping grade	Grasping grade of the graspable candidate specified in Result index focused
Collision point count	Number of collision points between the graspable candidate hand specified in Result index focused and the measurement point clouds
Surface correlation	3D Search surface correlation value of the graspable candidate specified in Result index focused
Contour correlation	3D Search Contour correlation value of the graspable candidate specified in Result index focused
Tilt of hand [deg]	Angle of the hand of the graspable candidate specified in Result index focused during approach
Rotation of hand [deg]	Amount of rotation of the graspable candidate flange specified in Result index focused
Depth of the work pos. [mm]	Depth of the graspable candidate specified in Result index focused in the work-piece position
Pick position X [mm]	Position X of the flange when picking the graspable candidate specified in Result index focused
Pick position Y [mm]	Position Y of the flange when picking the graspable candidate specified in Result index focused
Pick position Z [mm]	Position Z of the flange when picking the graspable candidate specified in Result index focused
Pick posture RX [deg] / Pick posture RZ [deg]	Posture RX of the flange when picking the graspable candidate specified in Result index focused If you set Posture type to <i>ZYZ Euler angle</i> , RX is replaced with RZ .
Pick posture RY [deg]	Posture RY of the flange when picking the graspable candidate specified in Result index focused

Displayed item	Description
Pick posture RZ [deg]	Posture RZ of the flange when picking the graspable candidate specified in Result index focused
Posture type	Robot posture type specified in the referenced HandEye Calibration processing items

The image specified in the Sub-image number in the image display setting is displayed in the *Image Display* area.

Sub-image number	Description of image to be displayed
0	The grasping pose/posture figure and the contour figure of the candidate workpiece are superimposed on the measurement image.
1	The grasping pose/posture figure, the contour figure of the candidate workpiece, and the contour figure of the rejected workpieces are superimposed on the measurement image.
2	The contour figure of the candidate workpiece and the contour figure of the rejected workpiece are superimposed on the measurement image.
3	The grasping pose/posture figure is superimposed on the measurement image.
4	The contour figure of the candidate workpiece is superimposed on the measurement image.
5	The contour figure of the rejected workpiece is superimposed on the measurement image.
6	The contour figure and rejection reason of the rejected workpiece are superimposed on the measurement image.
7	The grasping pose/posture, the contour figure of the candidate workpiece, and the contour figure and rejection reason of the rejected workpiece are superimposed on the measurement image.
8	The grasping pose/posture figure, the contour figure of the candidate workpiece, and the contour figure and rejection reason of the rejected workpiece are superimposed on the measurement image.
9	The contour figure of the candidate workpiece and the contour figure and rejection reason of the rejected workpiece are superimposed on the measurement image.
10	The grasping pose/posture figure and the contour figure of the rejected workpiece are superimposed on the measurement image.
11	The grasping pose/posture figure and the contour figure and rejection reason of the rejected workpieces are superimposed on the measurement image.
12	The grasping pose/posture figure and the rejection reason are superimposed on the measurement image.
13	The contour figure of the candidate workpiece and the rejection reason are superimposed on the measurement image.
14	The rejection reason is superimposed on the measurement image.

Key Points for Adjustment (Grasp Planning)

Adjust the setting parameters referring to the following points.

- **When tabs that follow the Coordinate settings tab are disabled**

Parameter to be adjusted	Remedy
Coordinate settings	The Coordinate settings tab may not be set appropriately. If a warning message is displayed in the Coordinate settings tab, review the settings accordingly. If the coordinate settings are not completed, you cannot set the items in tabs that follow this tab.

- **When grasp pose data referencing fails**

Parameter to be adjusted	Remedy
3D Data Manager processing item	If the reference data that you set in the Grasp pose data setting area is displayed as different reference data, the grasp pose data referenced by the 3D Data Manager processing item may be deleted. Restore (i.e., re-register and load from a grasp DB file) the grasp pose data.
3D Search processing item	If the reference data that you set in the Grasp pose data setting area is displayed as different reference data, the CAD data registered as a model may be changed. Check the model registration settings in the 3D Search processing item.
3D Data Manager processing item	If the reference data that you set in the Grasp pose data setting area is <None>, the pose of grasping set in the referenced 3D Data Manager processing item may be deleted. Restore (i.e., re-register and load from a grasp DB file) the grasp pose data.
3D Search processing item	If the reference data that you set in the Grasp pose data setting area is <None>, the CAD data registered as a model may be changed. Check the model registration settings in the 3D Search processing item.
3D Search processing item	If the reference data that you set in the Grasp pose data setting area is <None>, the model registration of the CAD data may be canceled. Check the model registration settings in the 3D Search processing item.

- **When the hand rotates beyond the limit value, although the amount of rotation of the hand is limited**

Parameter to be adjusted	Remedy
Order of grasping	The reference vectors for calculating the amount of rotation may not be set properly. Click Advanced in the Order of grasping tab and check the settings of Ref. vector for hand rot (robot base coord) and Ref. vector for hand rot (flange coord) .

- When the lower one is picked if more than one workpieces overlaps

Parameter to be adjusted	Remedy
Order of grasping	In the "Prioritization about the work. detection results" area, the settings related to the treatment of workpieces with the same priority may not be appropriate. Click Advanced in the Order of grasping tab and set Treatment about a same priority one to <i>Prioritize shallower pos. one</i> .
	In the "Prioritization about the work. detection results" area, the rejection level setting for Contour correlation may be too loose. Check the Contour correlation values for the upper and lower workpieces and then set the Rejection level for "Contour correlation" to a stricter value.
	In the "Prioritization about the work. detection results" area, the rejection level setting for Depth of the work pos. may be too loose. Set the Rejection level for "Depth of the work pos." based on the actual thickness of the workpiece.

- When the graspable candidate count is 0

Parameter to be adjusted	Remedy
Order of grasping	The Rejection level for Order of grasping may be too strict. Review the Rejection level setting.
Collision detection	The Collision detection settings may be too strict. Review the Collision detection settings.
Container Detection processing item	Due to incorrect container detection, a collision with the container may always occur. Review the settings of the Container Detection processing item.
3D Data Manager processing item Pose of grasping	The pick posture may be out of range because the grasp position is not registered as expected. Review the grasp position data (grasping DB data) settings.

- When the graspable candidate is not in the registered location

Parameter to be adjusted	Remedy
Order of grasping	The rotational symmetry setting for the hand may be incorrect. For hands without rotational symmetry, create hand data by disabling rotational symmetry in the HandMaker dialog, and create the grasp pose data again.

2-4-10 Measurement Results for Which Output Is Possible (Grasp Planning)

The following values can be output using processing items related to result output. It is also possible to reference measurement values from calculation expressions and other processing units.

Measurement items	Character string	Description
Judge	JG	Judgment result 0: No judgment (unmeasured) 1: Judgment result OK -1: Judgment result NG -10: Error (image format mismatch) -11: Error (unregistered model) -12: Error (insufficient memory) -20: Error (other errors)
Pick position X	PTX	Position X of the flange when picking the graspable candidate specified in Result index focused
Pick position Y	PTY	Position Y of the flange when picking the graspable candidate specified in Result index focused
Pick position Z	PTZ	Position Z of the flange when picking the graspable candidate specified in Result index focused
Pick posture RA	PRA	Posture RX of the flange when picking the graspable candidate specified in Result index focused If you set Posture type to <i>ZYX Euler angle</i> , RX is replaced with RZ .
Pick posture RY	PRB	Posture RY of the flange when picking the graspable candidate specified in Result index focused
Pick posture RZ	PRC	Posture RZ of the flange when picking the graspable candidate specified in Result index focused
Posture type	PRT	0: ZYX Euler angle, 1: ZYZ Euler angle, 2: XYZ Euler angle

2-4-11 External Reference Tables (Grasp Planning)

No.	Data name	Data ident	Set/Get	Data range
0	Judge	judge	Get only	0: No judgment (unmeasured), 1: Judgment result OK, -1: Judgment result NG, -10: Error (image format mismatch), -11: Error (unregistered model), -12: Error (insufficient memory), -20: Error (other errors)
6	Detected workpiece count	workDetectCnt	Get only	0 to 128
7	Graspable candidate count	graspableCount	Get only	0 to 1,024
8	Pick position X	pickTX	Get only	-10,000.0000 to 10,000.0000 [mm]
9	Pick position Y	pickTY	Get only	-10,000.0000 to 10,000.0000 [mm]
10	Pick position Z	pickTZ	Get only	-10,000.0000 to 10,000.0000 [mm]
11	Pick posture RA	pickRA	Get only	-180.0000 to 180.0000 [deg]
12	Pick posture RY	pickRB	Get only	-180.0000 to 180.0000 [deg]
13	Pick posture RZ	pickRC	Get only	-180.0000 to 180.0000 [deg]

No.	Data name	Data ident	Set/Get	Data range
14	Grasp position X (tool coord)	pickToolTX	Get only	-10,000.0000 to 10,000.0000 [mm]
15	Grasp position Y (tool coord)	pickToolTY	Get only	-10,000.0000 to 10,000.0000 [mm]
16	Grasp position Z (tool coord)	pickToolTZ	Get only	-10,000.0000 to 10,000.0000 [mm]
17	Grasp posture RA (tool coord)	pickToolRA	Get only	-180.0000 to 180.0000 [deg]
18	Grasp posture RY (tool coord)	pickToolRB	Get only	-180.0000 to 180.0000 [deg]
19	Grasp posture RZ (tool coord)	pickToolRC	Get only	-180.0000 to 180.0000 [deg]
32	Detected work index	searchResultID	Get only	-1 to 127
33	Grasp pose index	graspDbID	Get only	-1 to 2,147,483,647
34	ID of hand	handID	Get only	-1 to 2,147,483,647
35	Kind of hand	handKind	Get only	0: Vacuum hand, 1: Two finger hand
36	Stroke index of gripping with two-finger hand	strokeID	Get only	-1 to 2,147,483,647
37	Start stroke for gripping with two-finger hand	strokeStart	Get only	[mm]
38	Stop stroke for gripping with two-finger hand	strokeStop	Get only	[mm]
39	Outer grip	isClose	Get only	0: Inner grasping, 1: Outer grasping
40	The shrink length of vacuum hand	shrinkLength	Get only	[mm]
41	Surface correlation	correlationNorm	Get only	0.0000 to 100.0000
42	Contour correlation	correlationGrad	Get only	0.0000 to 100.0000
43	Tilt of hand	handTilt	Get only	0.0000 to 180.0000 [deg]
44	Rotation of hand	handRot	Get only	0.0000 to 180.0000 [deg]
45	Depth of the work pos.	depthFromCam	Get only	[mm]
47	Collision point count	numCollision	Get only	0 to 2,147,483,647
48	Grasping grade	grade	Get only	0: (A), 1: (B1), 2: (B2), 3: (B3), 4: (B4), 5: (B5), 6: (C1), 7: (C2), 8: (C3), 9: (C4), 10: (C5), 11: (C6), 12: (F)
49	Rank about surface correlation	rankCorrelationNorm	Get only	0: (-), 1: (C), 2: (B), 3: (A)
50	Rank about contour correlation	rankCorrelationGrad	Get only	0: (-), 1: (C), 2: (B), 3: (A)
51	Rank about tilt of hand	rankHandTilt	Get only	0: (-), 1: (C), 2: (B), 3: (A)
52	Rank about rotation of hand	rankHandRot	Get only	0: (-), 1: (C), 2: (B), 3: (A)

No.	Data name	Data ident	Set/Get	Data range
53	Rank about depth of the work pos.	rankDepthFromCam	Get only	0: (-), 1: (C), 2: (B), 3: (A)
56	Reason of rejection	rejectReason	Get only	0: Bad correlation or depth of workpiece, 1: Bad tilt of hand, 2: Bad rotation of hand, 3: Not the best one, 4: Collision with the floor, 5: Collision with the container, 6: Collision with the point cloud, 7: Collision with the workpiece, 8: Collision with the floor (approach), 9: Collision with the container (approach), 10: Collision with the point cloud (approach), 11: Collision with the workpiece (approach), 12: Early termination, 13: No problem
101	Ref unit number of workpiece detection unit	searchUnitNo	Set/Get	-1 to 9,999
109	Display image kind	ImageDispKind	Set/Get	0: Input - Measure image 0, 1: Camera - Depth image, 2: Camera - Captured(2D), 3: Camera - Captured(3D)
111	Ref scene number of handeye data unit	handeyeSceneNo	Set/Get	-1 to 1,023
112	Ref unit number of handeye data unit	handeyeUnitNo	Set/Get	-1 to 9,999
113	Flange position X (expr. value)	robotCoordX	Set/Get	-10,000.0000 to 10,000.0000 [mm] Robot base coord
114	Flange position Y (expr. value)	robotCoordY	Set/Get	-10,000.0000 to 10,000.0000 [mm] Robot base coord
115	Flange position Z (expr. value)	robotCoordZ	Set/Get	-10,000.0000 to 10,000.0000 [mm] Robot base coord
116	Flange posture RA (expr. value)	robotCoordRA	Set/Get	-180.0000 to 180.0000 [deg] Robot base coord
117	Flange posture RY (expr. value)	robotCoordRB	Set/Get	-180.0000 to 180.0000 [deg] Robot base coord
118	Flange posture RZ (expr. value)	robotCoordRC	Set/Get	-180.0000 to 180.0000 [deg] Robot base coord
120	Ref scene number of 3D data manager unit	data3dSceneNo	Set/Get	-1 to 1,023
121	Ref unit number of 3D data manager unit	data3dUnitNo	Set/Get	-1 to 9,999
122	Index of grasp DB	graspDbNo	Set/Get	-1 to 2,147,483,647
125	A rank threshold (surface correlation)	threshScore3dA	Set/Get	0.0000 to 100.0000
128	Rejection threshold (surface correlation)	threshScore3dReject	Set/Get	0.0000 to 100.0000

No.	Data name	Data ident	Set/Get	Data range
129	A rank threshold (contour correlation)	threshScore2dA	Set/Get	0.0000 to 100.0000
132	Rejection threshold (contour correlation)	threshScore2dReject	Set/Get	0.0000 to 100.0000
133	A rank threshold (tilt of hand)	threshTiltOfHandA	Set/Get	0.0000 to 180.0000
136	Rejection threshold (tilt of hand)	threshTiltOfHandRe- ject	Set/Get	0.0000 to 180.0000
137	A rank threshold (rotation of hand)	threshRotOfHandA	Set/Get	0.0000 to 180.0000
140	Rejection threshold (rotation of hand)	threshRotOfHandRe- ject	Set/Get	0.0000 to 180.0000
142	A rank threshold (depth of the work pos.)	threshDepthMmA	Set/Get	0.0000 to 10,000.0000 [mm]
145	Rejection threshold (depth of the work pos.)	threshDepthMmRe- ject	Set/Get	0.0000 to 10,000.0000 [mm]
156	Treatment about a same priority one	samePriorityKey	Set/Get	0: Prioritize shallower pos. one, 1: Prioritize higher correlation one
165	Kind of ref. vector for hand rot. (fixed end)	toolAlignVecBase- Kind	Set/Get	0: X-axis positive direction, 1: X-axis negative direction, 2: Y-axis positive direction, 3: Y-axis negative direction, 4: Angle from X-axis positive, 5: Custom
166	Ref. vector X for hand rot. (fixed end)	toolAlignVecBaseX	Set/Get	-1.0000 to 1.0000 Robot base coord
167	Ref. vector Y for hand rot. (fixed end)	toolAlignVecBaseY	Set/Get	-1.0000 to 1.0000 Robot base coord
168	Ref. vector Z for hand rot. (fixed end)	toolAlignVecBaseZ	Set/Get	-1.0000 to 1.0000 Robot base coord
169	Ref. angle for hand rot. (fixed end)	toolAlignVecBaseRZ	Set/Get	-180.0000 to 180.0000 [deg] Angle from robot base coord X-axis plus.
170	Kind of ref. vector for hand rot. (rot end)	toolAlignVecToolKind	Set/Get	0: X-axis positive direction, 1: X-axis negative direction, 2: Y-axis positive direction, 3: Y-axis negative direction, 4: Angle from X-axis positive, 5: Custom, 6: Y-axis negative direction (camera coord), 7: Current posture
171	Ref. vector X for hand rot. (rot end)	toolAlignVecToolX	Set/Get	-1.0000 to 1.0000 Flange coord
172	Ref. vector Y for hand rot. (rot end)	toolAlignVecToolY	Set/Get	-1.0000 to 1.0000 Flange coord
173	Ref. vector Z for hand rot. (rot end)	toolAlignVecToolZ	Set/Get	-1.0000 to 1.0000 Flange coord

No.	Data name	Data ident	Set/Get	Data range
174	Ref. angle for hand rot. (rot end)	toolAlignVecToolRZ	Set/Get	-180.0000 to 180.0000 [deg] Angle from flange coord X-axis plus.
179	Result index focused	focusResult	Set/Get	0 to 1,023
180	Detected work index focused	focusDtctWrk	Set/Get	0 to 127
181	Grasp pose index focused	focusGrasp	Set/Get	0 to 2,147,483,647
182	Result selection mode	selectResultMode	Set/Get	-2,147,483,647 to 2,147,483,647
184	Display result kind	drawType	Set/Get	0: Fingertip, 1: Fingertip and dir., 2: Finger wire frame, 3: Overall wire frame
191	Margin about collision with hand	handMargin	Set/Get	0.0000 to 10,000.0000 [mm]
192	Margin about collision between a workpiece and suction pad	padShrinkMargin	Set/Get	0.0000 to 10,000.0000 [mm]
195	Target object for collision detection	obstacle	Set/Get	0: None, 1: Floor, 2: Container, 3: Container + Floor
196	Ref scene number of container data unit	cntnrSceneNo	Set/Get	-1 to 1,023
197	Ref unit number of container data unit	cntnrUnitNo	Set/Get	-1 to 9,999
198	Margin about collision with the surrounding environment	obstacleMargin	Set/Get	0.0000 to 10,000.0000 [mm]
199	Tolerance about collision with point cloud	maxCollisionPnt	Set/Get	0 to 1,000 [point]
200	Outlier height of point cloud	maxHeightFromFloor	Set/Get	10.0000 to 10,000.0000 [mm]
203	Upper limit of graspable candidate count	upperGraspable	Set/Get	0 to 1,024
204	Lower limit of graspable candidate count	lowerGraspable	Set/Get	0 to 1,024
205	Upper limit of grasping grade	upperGrade	Set/Get	0: (A), 1: (B1), 2: (B2), 3: (B3), 4: (B4), 5: (B5), 6: (C1), 7: (C2), 8: (C3), 9: (C4), 10: (C5), 11: (C6), 12: (F)
206	Lower limit of grasping grade	lowerGrade	Set/Get	0: (A), 1: (B1), 2: (B2), 3: (B3), 4: (B4), 5: (B5), 6: (C1), 7: (C2), 8: (C3), 9: (C4), 10: (C5), 11: (C6), 12: (F)
207	Upper limit of collision point count	upperNumCollision	Set/Get	0 to 10,000
208	Lower limit of collision point count	lowerNumCollision	Set/Get	0 to 10,000
209	Upper limit of surface correlation	upperCorrelation-Norm	Set/Get	0.0000 to 100.0000

No.	Data name	Data ident	Set/Get	Data range
210	Lower limit of surface correlation	lowerCorrelation-Norm	Set/Get	0.0000 to 100.0000
211	Upper limit of contour correlation	upperCorrelation-Grad	Set/Get	0.0000 to 100.0000
212	Lower limit of contour correlation	lowerCorrelation-Grad	Set/Get	0.0000 to 100.0000
213	Upper limit of pick position X	upperPickTX	Set/Get	-10,000.0000 to 10,000.0000 [mm]
214	Lower limit of pick position X	lowerPickTX	Set/Get	-10,000.0000 to 10,000.0000 [mm]
215	Upper limit of pick position Y	upperPickTY	Set/Get	-10,000.0000 to 10,000.0000 [mm]
216	Lower limit of pick position Y	lowerPickTY	Set/Get	-10,000.0000 to 10,000.0000 [mm]
217	Upper limit of pick position Z	upperPickTZ	Set/Get	-10,000.0000 to 10,000.0000 [mm]
218	Lower limit of pick position Z	lowerPickTZ	Set/Get	-10,000.0000 to 10,000.0000 [mm]
219	Upper limit of pick posture RA	upperPickRA	Set/Get	-180.0000 to 180.0000 [deg]
220	Lower limit of pick posture RA	lowerPickRA	Set/Get	-180.0000 to 180.0000 [deg]
221	Upper limit of pick posture RY	upperPickRB	Set/Get	-180.0000 to 180.0000 [deg]
222	Lower limit of pick posture RY	lowerPickRB	Set/Get	-180.0000 to 180.0000 [deg]
223	Upper limit of pick posture RZ	upperPickRC	Set/Get	-180.0000 to 180.0000 [deg]
224	Lower limit of pick posture RZ	lowerPickRC	Set/Get	-180.0000 to 180.0000 [deg]
225	Upper limit of tilt of hand	upperHandTilt	Set/Get	0.0000 to 180.0000 [deg]
226	Lower limit of tilt of hand	lowerHandTilt	Set/Get	0.0000 to 180.0000 [deg]
227	Upper limit of rotation of hand	upperHandRot	Set/Get	0.0000 to 180.0000 [deg]
228	Lower limit of rotation of hand	lowerHandRot	Set/Get	0.0000 to 180.0000 [deg]
229	Upper limit of depth of the work pos.	upperDepthFrom-Cam	Set/Get	0.0000 to 10,000.0000
230	Lower limit of depth of the work pos.	lowerDepthFrom-Cam	Set/Get	0.0000 to 10,000.0000
231	Pick posture type	judgePostureType	Set/Get	0: ZYX Euler angle, 1: ZYZ Euler angle, 2: XYZ Euler angle For confirming
232	Reflect to overall judgement	overallJudge	Set/Get	0: ON, 1: OFF
1009	Robot mount	machineMount	Get only	-1: Unspecified, 0: Floor mount, 1: Ceiling mount

No.	Data name	Data ident	Set/Get	Data range
1010	Robot type	machineType	Get only	-1: Unspecified, 0: 3-axis(XYZ) robot, 1: 4-axis(XYZR) robot, 2: 6-axis(XYZWPR) robot
1011	Robot posture type	poseRotationType	Get only	-1: Unspecified, 0: ZYX Euler angle, 1: ZYZ Euler angle, 2: XYZ Euler angle
1012	Camera mount	cameraMount	Get only	-1: Unspecified, 0: Fixed camera, 1: On hand camera
1013	Camera position X (calib. result)	resultTransCamTX	Get only	-10,000.0000 to 10,000.0000 [mm]
1014	Camera position Y (calib. result)	resultTransCamTY	Get only	-10,000.0000 to 10,000.0000 [mm]
1015	Camera position Z (calib. result)	resultTransCamTZ	Get only	-10,000.0000 to 10,000.0000 [mm]
1016	Camera posture RA (calib. result)	resultTransCamRA	Get only	-180.0000 to 180.0000 [deg]
1017	Camera posture RY (calib. result)	resultTransCamRB	Get only	-180.0000 to 180.0000 [deg]
1018	Camera posture RZ (calib. result)	resultTransCamRC	Get only	-180.0000 to 180.0000 [deg]
1019	Camera posture type (calib. result)	resultPoseRotType	Get only	-1: Unspecified, 0: ZYX Euler angle, 1: ZYZ Euler angle, 2: XYZ Euler angle
1020	Flange position X	robotCoordXEval	Get only	-10,000.0000 to 10,000.0000 [mm] Robot base coord
1021	Flange position Y	robotCoordYEval	Get only	-10,000.0000 to 10,000.0000 [mm] Robot base coord
1022	Flange position Z	robotCoordZEval	Get only	-10,000.0000 to 10,000.0000 [mm] Robot base coord
1023	Flange posture RA	robotCoordRAEval	Get only	-180.0000 to 180.0000 [deg] Robot base coord
1024	Flange posture RY	robotCoordRBEval	Get only	-180.0000 to 180.0000 [deg] Robot base coord
1025	Flange posture RZ	robotCoordRCEval	Get only	-180.0000 to 180.0000 [deg] Robot base coord
1026	Flange posture type	robotCoordRTEval	Get only	0:ZYX Euler angle, 1:ZYZ Euler angle, 2:XYZ Euler angle
1027	Camera position X	cam2refX	Get only	-10,000.0000 to 10,000.0000 [mm] Robot base coord
1028	Camera position Y	cam2refY	Get only	-10,000.0000 to 10,000.0000 [mm] Robot base coord
1029	Camera position Z	cam2refZ	Get only	-10,000.0000 to 10,000.0000 [mm] Robot base coord
1030	Camera posture RA	cam2refRA	Get only	-180.0000 to 180.0000 [deg] Robot base coord
1031	Camera posture RY	cam2refRB	Get only	-180.0000 to 180.0000 [deg] Robot base coord
1032	Camera posture RZ	cam2refRC	Get only	-180.0000 to 180.0000 [deg] Robot base coord

No.	Data name	Data ident	Set/Get	Data range
1033	Camera posture type	cam2refRT	Get only	0:ZYX Euler angle, 1:ZYZ Euler angle, 2:XYZ Euler angle
1045	Name of grasp DB	graspDataName	Get only	-
1049	Pick coord RA	pickRAJudge	Get only	-180.0000 to 180.0000 [deg] For confirming
1050	Pick coord RY	pickRBJudge	Get only	-180.0000 to 180.0000 [deg] For confirming
1051	Pick coord RZ	pickRCJudge	Get only	-180.0000 to 180.0000 [deg] For confirming
100000+N (N=0 to 127)	Pick position X 0 : Pick position X 127	resultsPickTX0 : resultsPickTX127	Get only	-10,000.0000 to 10,000.0000 [mm]
110000+N (N=0 to 127)	Pick position Y 0 : Pick position Y 127	resultsPickTY0 : resultsPickTY127	Get only	-10,000.0000 to 10,000.0000 [mm]
120000+N (N=0 to 127)	Pick position Z 0 : Pick position Z 127	resultsPickTZ0 : resultsPickTZ127	Get only	-10,000.0000 to 10,000.0000 [mm]
130000+N (N=0 to 127)	Pick posture RA 0 : Pick posture RA 127	resultsPickRA0 : resultsPickRA127	Get only	-180.0000 to 180.0000 [deg]
140000+N (N=0 to 127)	Pick posture RY 0 : Pick posture RY 127	resultsPickRB0 : resultsPickRB127	Get only	-180.0000 to 180.0000 [deg]
150000+N (N=0 to 127)	Pick posture RZ 0 : Pick posture RZ 127	resultsPickRC0 : resultsPickRC127	Get only	-180.0000 to 180.0000 [deg]
160000+N (N=0 to 127)	Grasp position X (tool coord) 0 : Grasp position X (tool coord) 127	resultsPickToolTX0 : resultsPick- ToolTX127	Get only	-10,000.0000 to 10,000.0000 [mm]
170000+N (N=0 to 127)	Grasp position Y (tool coord) 0 : Grasp position Y (tool coord) 127	resultsPickToolTY0 : resultsPickTool- TY127	Get only	-10,000.0000 to 10,000.0000 [mm]
180000+N (N=0 to 127)	Grasp position Z (tool coord) 0 : Grasp position Z (tool coord) 127	resultsPickToolTZ0 : resultsPick- ToolTZ127	Get only	-10,000.0000 to 10,000.0000 [mm]
190000+N (N=0 to 127)	Grasp posture RA (tool coord) 0 : Grasp posture RA (tool coord) 127	resultsPickToolRA0 : resultsPickTool- RA127	Get only	-180.0000 to 180.0000 [deg]

No.	Data name	Data ident	Set/Get	Data range
200000+N (N=0 to 127)	Grasp posture RY (tool coord) 0 : Grasp posture RY (tool coord) 127	resultsPickToolRB0 : resultsPick- ToolRB127	Get only	-180.0000 to 180.0000 [deg]
210000+N (N=0 to 127)	Grasp posture RZ (tool coord) 0 : Grasp posture RZ (tool coord) 127	resultsPickToolRC0 : resultsPick- ToolRC127	Get only	-180.0000 to 180.0000 [deg]
340000+N (N=0 to 127)	Detected work index 0 : Detected work index 127	resultsSearchResul- tID0 : resultsSearchResul- tID127	Get only	-1 to 127
350000+N (N=0 to 127)	Grasp pose index 0 : Grasp pose index 127	resultsGraspDbID0 : resultsGraspD- bID127	Get only	-1 to 2,147,483,647
360000+N (N=0 to 127)	ID of hand 0 : ID of hand 127	resultsHandID0 : resultsHandID127	Get only	-1 to 2,147,483,647
370000+N (N=0 to 127)	Kind of hand using 0 : Kind of hand 127	resultsHandKind0 : resultsHandKind127	Get only	0: Vacuum hand, 1: Two fin- ger hand
380000+N (N=0 to 127)	Stroke index of grip- ping with two-finger hand 0 : Stroke index of grip- ping with two-finger hand 127	resultsStrokeID0 : resultsStrokeID127	Get only	-1 to 2,147,483,647
390000+N (N=0 to 127)	Start stroke for grip- ping with two-finger hand 0 : Start stroke for grip- ping with two-finger hand 127	resultsStrokeStart0 : resultsStrokeS- tart127	Get only	[mm]
400000+N (N=0 to 127)	Stop stroke for grip- ping with two-finger hand 0 : Stop stroke for grip- ping with two-finger hand 127	resultsStrokeStop0 : resultsStroke- Stop127	Get only	[mm]
410000+N (N=0 to 127)	Outer grip 0 : Outer grip 127	resultsIsClose0 : resultsIsClose127	Get only	0: Inner grasping, 1: Outer grasping

No.	Data name	Data ident	Set/Get	Data range
420000+N (N=0 to 127)	The shrink length of vacuum hand 0 : The shrink length of vacuum hand 127	resultsShrinkLength0 : resultsShrinkLength127	Get only	[mm]



Compensate Image

This chapter describes how to apply positional compensation for measurement objects on the input image to measure accurately.

3-1	FH series 3D robot vision system Processing items	3-2
3-1-1	Compensate image.....	3-2

3-1 FH series 3D robot vision system Processing items

In FH series 3D robot vision system, the processing items that can be used with the FH series are different. The following shows the usability of processing items of FH series 3D robot vision system. Refer to the *Vision System FH/FHV Series Processing Item Function Reference Manual (Cat. No. Z341)*, for information on each processing item other than the FH series 3D robot vision system processing items.



Precautions for Correct Use

FH series 3D robot vision system cannot load data including processing items which it cannot be handled.

3-1-1 Compensate image

Processing item	Support	Processing item	Support
Position Compensation	OK	Stripes Removal Filter II	OK
Filtering	OK	Polar Transformation	OK
Background Suppression	OK	Trapezoidal Correction	OK
Brightness Correct Filter	OK	Machine Simulator	-
Color Gray Filter	OK	Image Subtraction	OK
Extract Color Filter	OK	OK Advanced filter	OK
Anti Color Shading	OK	Panorama	-

4

Support Inspection and Measurement

This chapter describes how to set calculations and how to get or view data.

4

4-1	FH series 3D robot vision system Processing items	4-2
4-1-1	Support measurement	4-2
4-2	3D Data Manager	4-3
4-2-1	CAD Data (3D Data Manager)	4-3
4-2-2	Hand Data (3D Data Manager)	4-6
4-2-3	Grasp DB (3D Data Manager)	4-22
4-2-4	Key Points for Test Measurement and Adjustment (3D Data Manager)	4-36
4-2-5	Measurement Results for Which Output Is Possible (3D Data Manager)	4-38
4-2-6	External Reference Tables (3D Data Manager)	4-39
4-3	Camera Calibration AOS	4-40
4-3-1	Settings Flow (Camera Calibration AOS)	4-41
4-3-2	Input parameter (Camera Calibration AOS)	4-42
4-3-3	Geometric var. check (Camera Calibration AOS)	4-43
4-3-4	Calib. setting (Camera Calibration AOS)	4-46
4-3-5	Data in-out (Camera Calibration AOS)	4-53
4-3-6	Key Points for Test Measurement and Adjustment (Camera Calibration AOS)	4-54
4-3-7	Measurement Results for Which Output Is Possible (Camera Calibration AOS)	4-58
4-3-8	External Reference Tables (Camera Calibration AOS)	4-59
4-4	HandEye Calibration	4-61
4-4-1	Settings Flow (HandEye Calibration)	4-62
4-4-2	Instruments settings (HandEye Calibration)	4-63
4-4-3	Target settings (HandEye Calibration)	4-65
4-4-4	Sampling settings (HandEye Calibration)	4-67
4-4-5	Calibration result (HandEye Calibration)	4-71
4-4-6	Key Points for Test Measurement and Adjustment (HandEye Calibration) ..	4-73
4-4-7	Measurement Results for Which Output Is Possible (HandEye Calibration)	4-76
4-4-8	External Reference Tables (HandEye Calibration)	4-77

4-1 FH series 3D robot vision system Processing items

In FH series 3D robot vision system, the processing items that can be used with the FH series are different. The following shows the usability of processing items of FH series 3D robot vision system. Refer to the *Vision System FH/FHV Series Processing Item Function Reference Manual (Cat. No. Z341)*, for information on each processing item other than the FH series 3D robot vision system processing items.



Precautions for Correct Use

FH series 3D robot vision system cannot load data including processing items which it cannot be handled.

4-1-1 Support measurement

Processing item	Support	Processing item	Support
3D Data Manager *1	OK	Iris	OK
Camera Calibration AOS *1	OK	Parallelize	-
HandEye Calibration *1	OK	Parallelize Task	-
Unit Macro	OK	Statistics	OK
Unit Calculation Macro	OK	Calibration Data Reference	-
Calculation	OK	Position Data Calculation	-
Line Regression	OK	Stage Data	-
Circle Regression	OK	Robot Data	OK
Precise Calibration	-	Vision Master Calibration	-
User Data	-	PLC Master Calibration	-
Set Unit Data	-	Transfer Position Data	-
Get Unit Data	-	Calc Axis Move	-
Set Unit Figure	-	Calc Axis Move by Multipoint	-
Get Unit Figure	-	Detection Point	-
Trend Monitor	OK	Manual Position Setting	-
Image Logging	OK	Camera Calibration	-
Image Conversion Logging	OK	Data Save	OK
Data Logging	-	Conveyor Calibration	-
Elapsed Time	OK	Scene	OK
Wait	OK	System information	OK
Focus	OK		

*1. This is a processing item specific to the FH series 3D robot vision system.

4-2 3D Data Manager

This is a processing item specific to the FH series 3D robot vision system.

This processing item manages the CAD data, hand data, and grasp pose data (grasp DB data) required for picking applications.

Used in the Following Case

- When referencing CAD data from the **3D Search** processing item
- When referencing hand data or grasp pose data (grasp DB data) from the **Grasp Planning** processing item

Example: Bulk picking of parts in a container

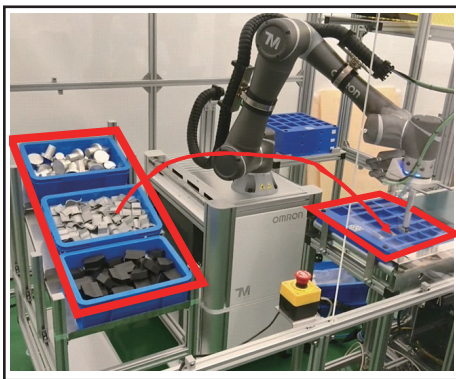

Precautions for Correct Use

This processing item can load STL-format CAD data (.stl).

4-2-1 CAD Data (3D Data Manager)

Set the CAD data to be held in this processing item.

This processing item can load STL-format CAD data (.stl).

The following are the specifications of CAD data that can be loaded.

- STL (ASCII)

Data in which the first line starts with [solid arbitrary character string], triangle data follows, and the last line ends with [endsolid arbitrary character string] (There must not be more than one solid and endsolid.)
- STL (Binary)

Data in which the first 80 bytes are an arbitrary character string, the next 4 bytes are an integer indicating the number of triangles, and triangle data as much as the number of triangles follows

Example:

STL (ASCII)	STL (Binary)
solid sample	UINT8[80] // Header (Arbitrary character string)
facet normal nxnynz	UINT32 // Number of triangles
outer loop	float[3] // Normal vector
vertex V1x V1y V1z	float[3] // Coordinate 1
vertex V2x V2y V2z	float[3] // Coordinate 2
vertex V3x V3y V3z	float[3] // Coordinate 3
end loop	UINT16 // Unused data
endfacet	...
...	float[3] // Normal vector
facet normal nxnynz	float[3] // Coordinate 1
outer loop	float[3] // Coordinate 2
vertex V1x V1y V1z	float[3] // Coordinate 3
vertex V2x V2y V2z	UINT16 // Unused data
vertex V3x V3y V3z	
end loop	
endfacet	
endsolid sample	



Precautions for Correct Use

- Depending on the CAD data, it may take some time for drawing.
- If the file path contains 256 characters or more, the data cannot be loaded.

1 In the Item tab area, click the **CAD Data** tab.

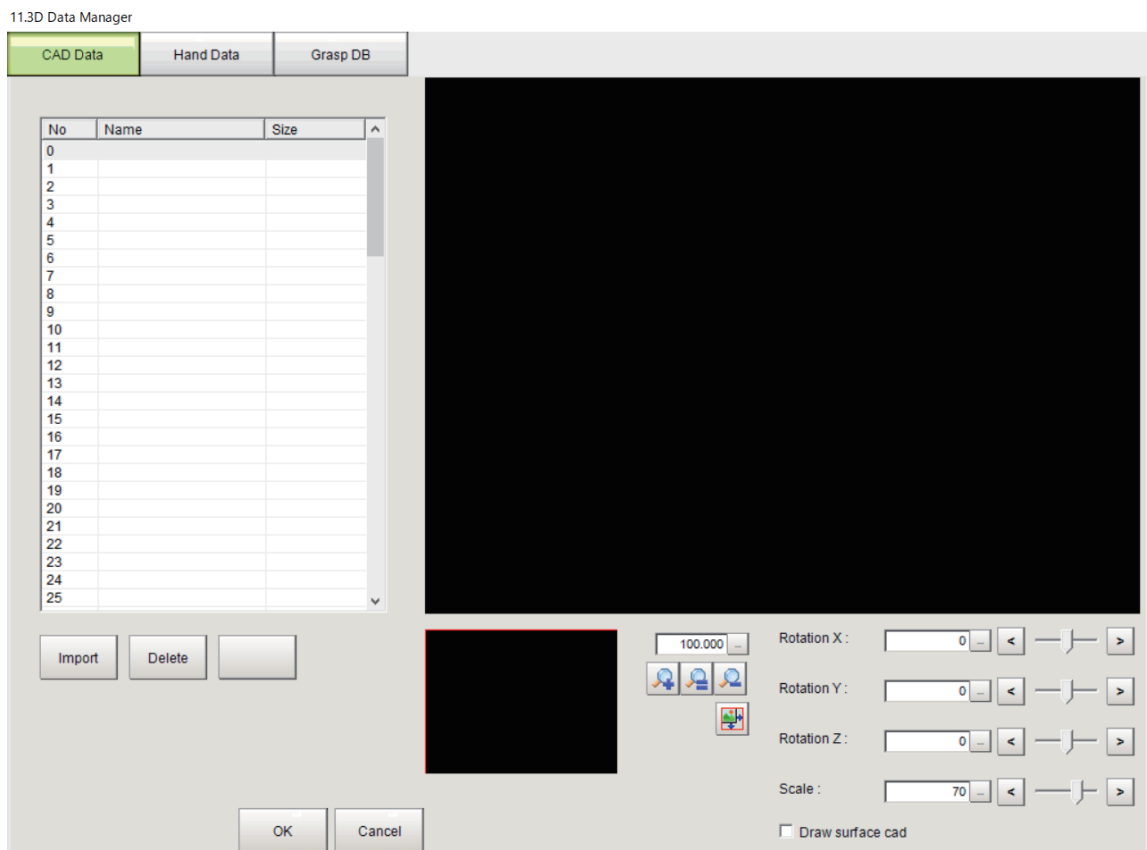

- 2 Select the number of the line in which to add CAD data.
The background color of the selected line changes.
You can set up to 100 data items.
To add data to a line number with set data, click the **Delete** button to delete the set data.
- 3 Click the **Import** button and select the CAD data to load in **File Explorer**.
The loaded data is drawn and its name and size are displayed.

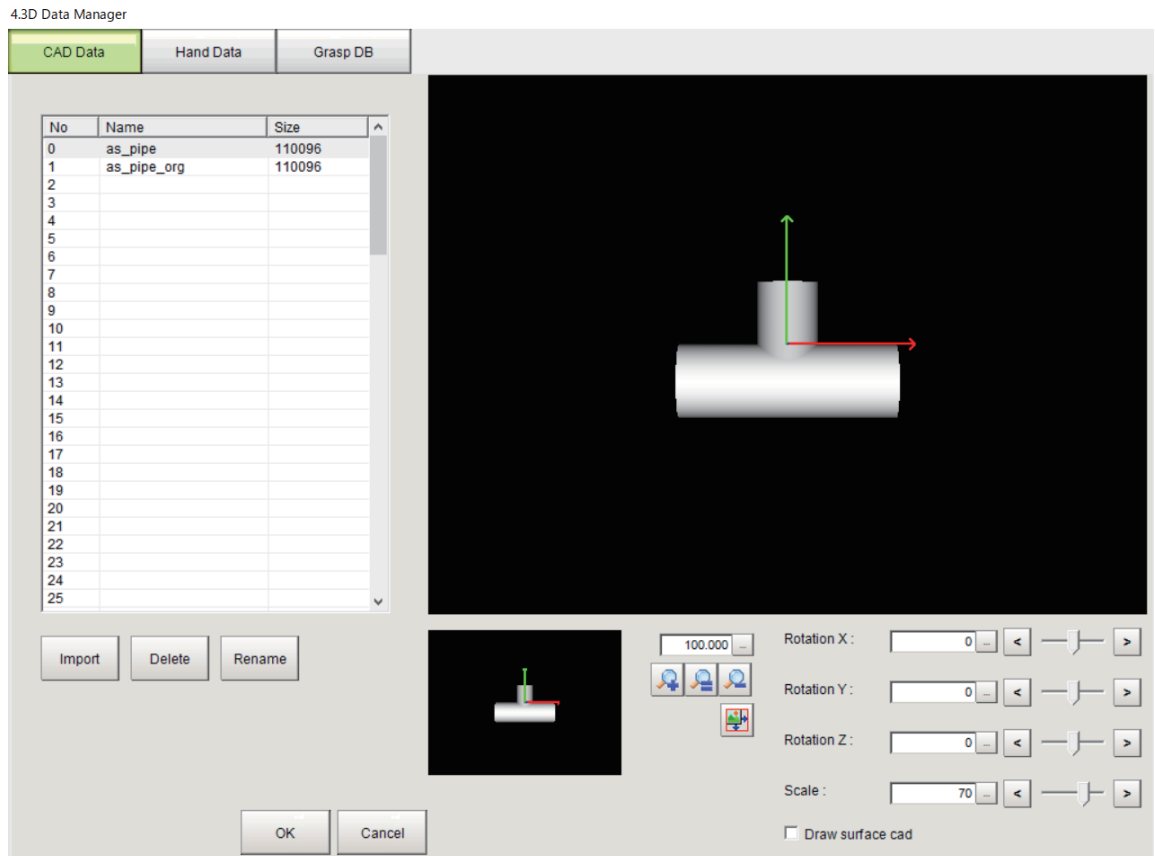

- 4 If necessary, click the **Rename** button and change the name.
- 5 Check the drawn image.

Setting item	Setting value [Factory default]	Description
Rotation X	-180 to 180 [0]	Direction of rotation of the X axis from the viewpoint of the CAD data displayed on the setting screen
Rotation Y	-180 to 180 [0]	Direction of rotation of the Y axis from the viewpoint of the CAD data displayed on the setting screen
Rotation Z	-180 to 180 [0]	Direction of rotation of the Z axis from the viewpoint of the CAD data displayed on the setting screen
Scale	1 to 100 [70]	Zoom rate of the CAD data displayed on the setting screen
Draw surface cad	<ul style="list-style-type: none"> • Checked • [Unchecked] 	Check this to draw invisible surfaces (on the back side of the mesh) when drawing the CAD data. (You can use surface CAD, etc. to check how they are displayed.)

4-2-2 Hand Data (3D Data Manager)

Create hand data that defines the type, shape, and motion of the hand used for the actual picking. The created hand data is used for the grasp DB and the **Grasp Planning** processing item to register poses of grasping and detect collisions with the workpiece.

Hand data consists of two simple figures, i.e., rectangles and cylinders. Using these simple figures of hand data enables high-speed collision detection. Since the hand part of CAD data is fixed in position, multiple CAD data are required to change the opening width, etc. of a hand. However, hand data allows for setting the moving and sucking sections, so you can use a single hand data to express various states by changing the opening width and the amount of contraction.

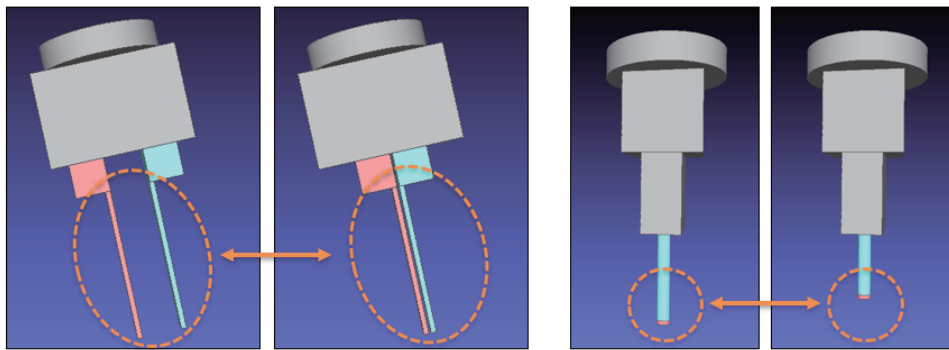

For safe picking, you need to create hand data with dimensions close to the actual objects.

Set the same dimensions as the actual hand for parts that require accurate collision detection (e.g., the tip of the hand that grasps the workpiece).

However, for robot mounting parts and actuators that do not require accurate collision detection, you may set approximate figures because they are not necessarily reproduced the same as the CAD data. You can create two types of hand data, i.e., two-finger hand and one-point vacuum hand.

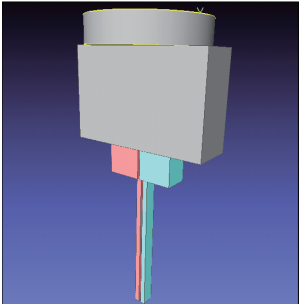
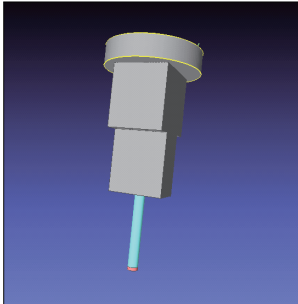
Two-finger hand	One-point vacuum hand
A two-finger hand has left and right fingers. The left and right fingers are moving parts that allow for setting the opening width, etc.	A one-point vacuum hand has a single suction pad. You can set a Bellows part that contracts during suction.
Example: 	Example: 



Precautions for Correct Use

- Hand data uses the flange coordinate system. With the actual hand mounted on the robot, check the flange coordinate system and create hand data by placing rectangles and cylinders according to the orientation of the flange coordinate system.

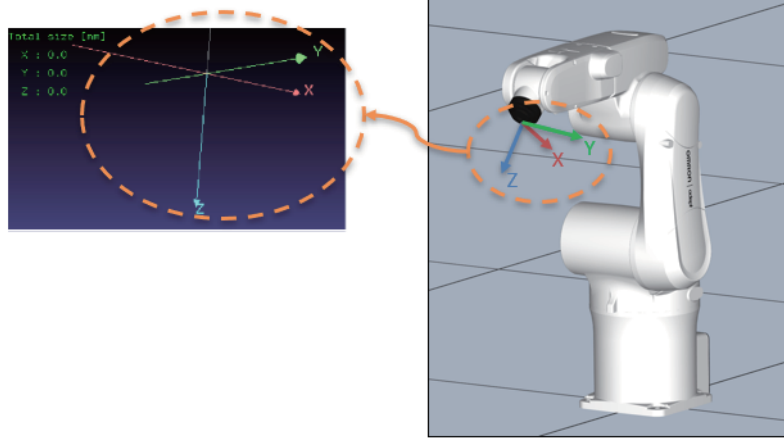

- Create hand data as part of the hand also for the 3D vision sensor and mounting jigs that are linked to it, since they are needed to detect collisions with the workpiece.
- When you edit hand data, the changed shapes and positions are not reflected in the grasp DB. Edit the hand data in the grasp DB as well.

Two-finger Hand

- 1 In the Item tab area, click the **Hand Data** tab.

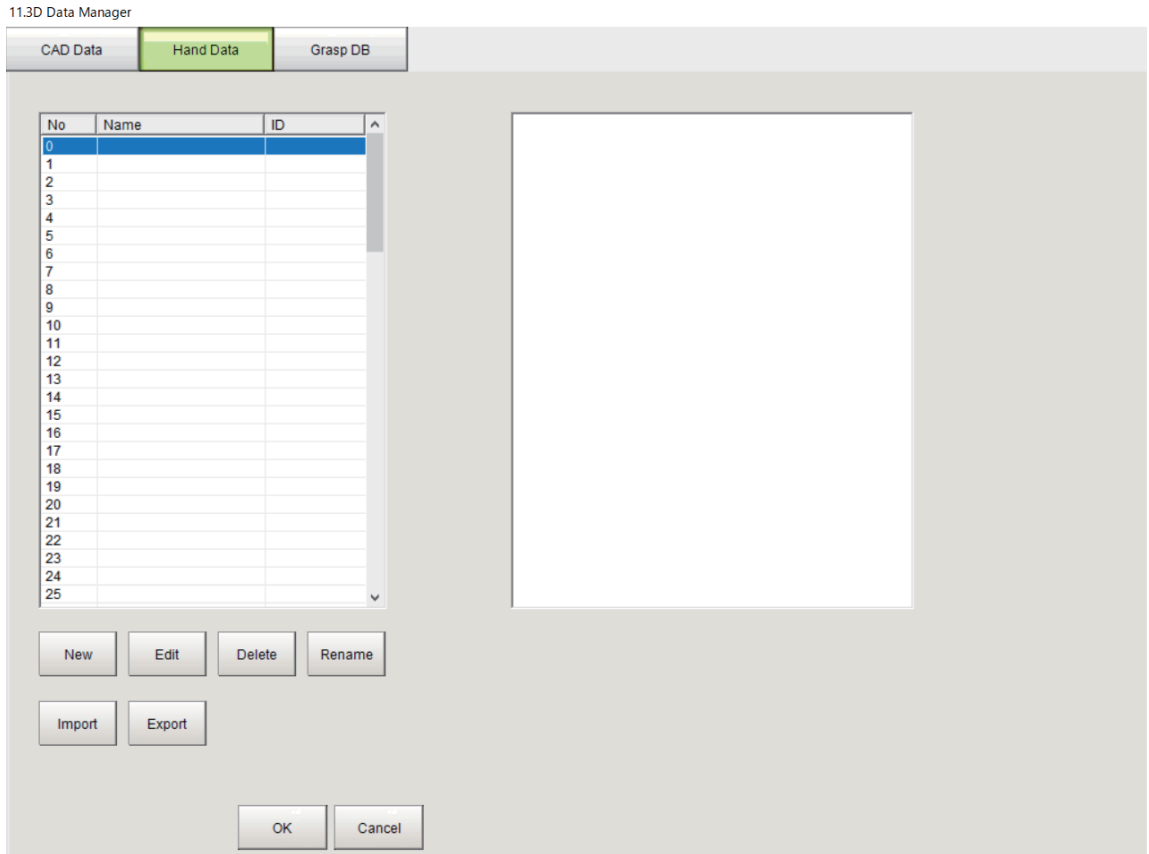

- 2 Select the number of the line in which to add hand data.
The background color of the selected line changes.
You can set up to 100 data items.
To add data to a line number with set data, click the **Delete** button to delete the set data.
- 3 Click the **New** button. You will create the hand data in the **HandMaker** dialog.
- 4 The **Create New** dialog is displayed. As the hand type, select *Two Fingers*. Set the hand ID and click **OK**.

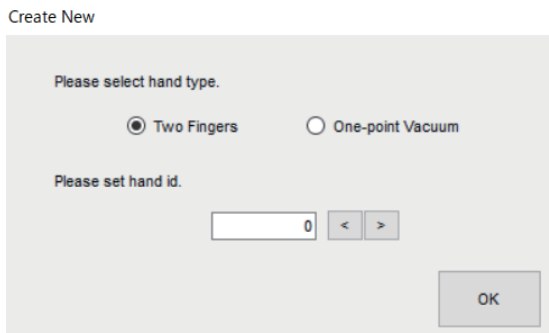

Setting item	Setting value [Factory default]	Description
Hand type	<ul style="list-style-type: none"> • [Two Fingers] • One-point Vacuum 	Select the type of the hand data to create.

Setting item	Setting value [Factory default]	Description
Hand ID	0 to 10,000 [0]	Set the hand ID.

5 Create the hand data in the **HandMaker** dialog.

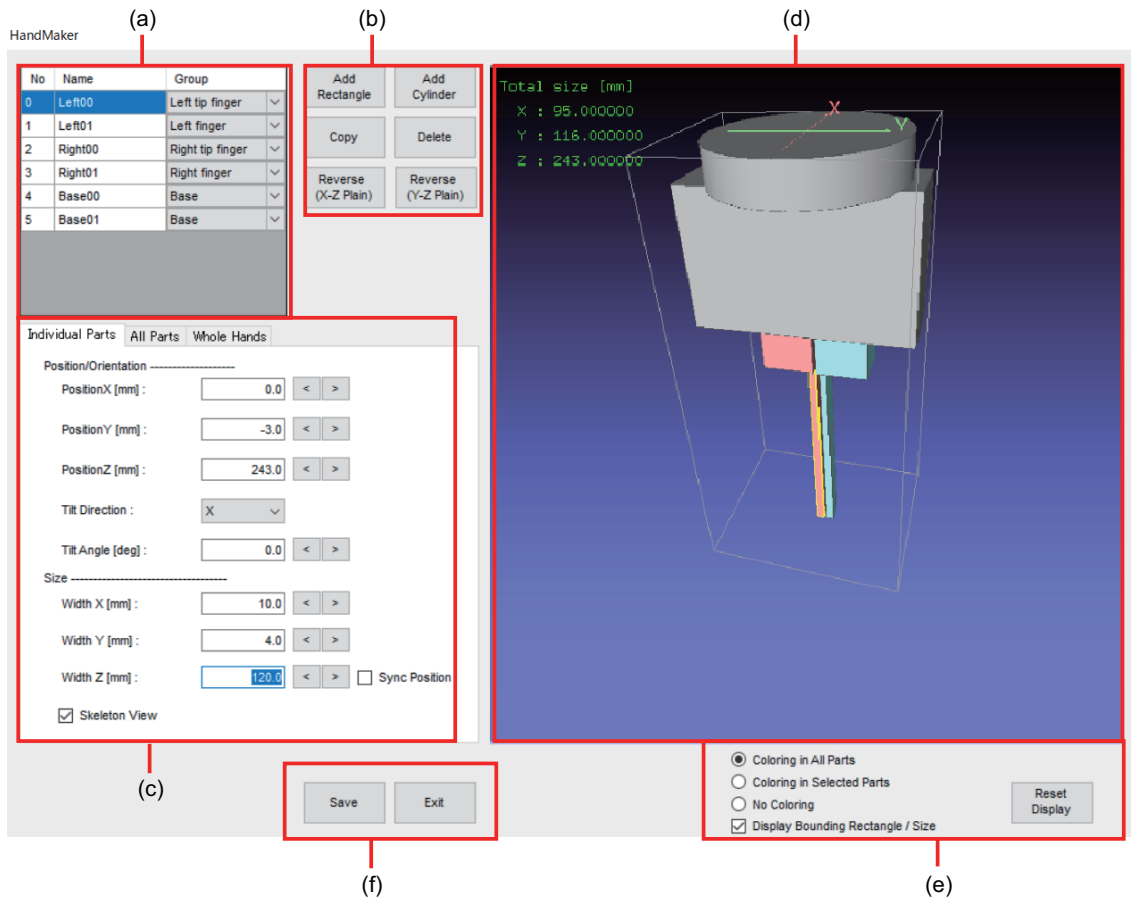

a) Part list view

The names and groups of hand parts are listed. Select the part to edit or display from the list.

You can add up to 128 parts to the list. The sort and filter functions are not available.

To change the part name, double-click it in the **Name** column.

To change the group, click it in the **Group** column.

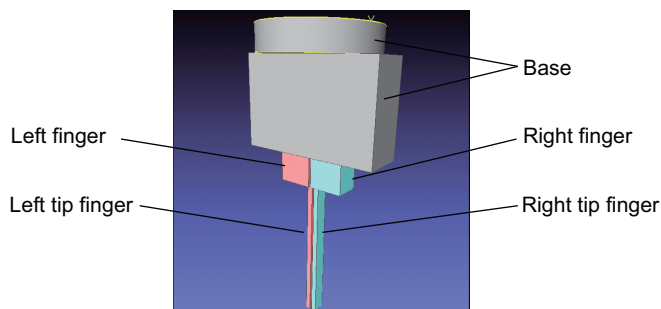

Item	Description
Left finger	Left finger part. This is movable. You can set up to 64 parts. It is displayed in red.

Item	Description
Left tip finger	Left finger tip part. This is movable. You must register only one part. It is displayed in red.
Right finger	Right finger part. This is movable. You can set up to 64 parts. It is displayed in light blue.
Right tip finger	Right finger tip part. This is movable. You must register only one part. It is displayed in light blue.
Base	Base parts. These are fixed. You can set up to 64 parts. You must register at least one part. It is displayed in gray.

The wireframe of the selected part in the part list view is highlighted in yellow in the image display area.

b) Operation button

Item	Description
Add Rectangle	Add a rectangle to the end of the part list view.
Add Cylinder	Add a cylinder to the end of the part list view.
Copy	Add a copy of the selected part in the part list view to the end of the list. The changed name cannot be copied.
Delete	Delete the part selected in the parts list view from the list.
Reverse (X-Z Plain)	Reverse the position of the selected part in the part list view with respect to the XZ plane of the tool coordinate system.
Reverse (Y-Z Plain)	Reverse the position of the selected part in the part list view with respect to the YZ plane of the tool coordinate system.

c) Setting tab area

• Individual Parts tab

Set the position/posture and size of the selected part in the part list view.

For rectangles

Individual Parts All Parts Whole Hands

Position/Orientation -----

PositionX [mm]: < >

PositionY [mm]: < >

PositionZ [mm]: < >

Tilt Direction: X ▾

Tilt Angle [deg]: < >

Size -----

Width X [mm]: < >

Width Y [mm]: < >

Width Z [mm]: < > Sync Position

Skeleton View

For cylinders

Individual Parts All Parts Whole Hands

Position/Orientation -----

PositionX [mm]: < >

PositionY [mm]: < >

PositionZ [mm]: < >

Tilt Direction: X ▾

Tilt Angle [deg]: < >

Size -----

Diameter [mm]: < >

Height [mm]: < > Sync Position

Skeleton View

Setting item	Setting value [Factory default]	Description
Position X [mm]	-10,000.0 to 10,000.0 [0.0]	Set the position in which to place the part.
Position Y [mm]	-10,000.0 to 10,000.0 [0.0]	
Position Z [mm]	-10,000.0 to 10,000.0 [0.0]	

Setting item	Setting value [Factory default]	Description
Tilt Direction	<ul style="list-style-type: none"> • [X] • Y • Z 	Set the reference axis around which to rotate the part.
Tilt Angle [deg]	-180.0 to 180.0 [0.0]	Set the rotation angle of the part.
Width X [mm]	1.0 to 10,000.0 [10.0]	These items are displayed for rectangle parts only. Set the size of the rectangular part.
Width Y [mm]	1.0 to 10,000.0 [10.0]	
Width Z [mm]	1.0 to 10,000.0 [10.0]	
Diameter [mm]	1.0 to 10,000.0 [30.0]	These items are displayed for cylinder parts only. Set the size of the cylinder part.
Height [mm]	1.0 to 10,000.0 [10.0]	
Sync Position	<ul style="list-style-type: none"> • Checked • [Unchecked] 	Check this to fix the top of the part (position in the negative Z direction) when the Width Z or Height setting is changed.
Skeleton View	<ul style="list-style-type: none"> • [Checked] • Unchecked 	Check this to display the selected part as a skeleton when the Skeleton View is enabled in the grasp registration tool GraspTeachGUI .

- All Parts tab

Move all parts at once.

Individual Parts | **All Parts** | Whole Hands

Group -----

Move Left finger ▾

Move Closer (Right and Left Fingers)

Move Further (Right and Left Fingers)

Direction : X ▾

Amount of Movement [mm] : < >







Setting item	Setting value [Factory default]	Description
Move	<ul style="list-style-type: none"> • Left finger • Left tip finger • Right finger • Right tip finger • Base 	Select the part group to move.
Move Closer (Right and Left Fingers)	-	Set the movement direction of the part group to move so that it moves closer to the left finger (Left finger and Left tip finger) or the right finger (Right finger and Right tip finger).

Setting item	Setting value [Factory default]	Description
Move Further (Right and Left Fingers)	-	Set the movement direction of the part group to move so that it moves away from the left finger (Left finger and Left tip finger) or right finger (Right finger and Right tip finger).
Direction	<ul style="list-style-type: none"> • [X] • Y 	Set the axis along which to move the part.
Amount of Move- ment [mm]	-10,000.0 to 10,000.0 [0]	Set the distance to move the part in one click of Execute .
Execute	-	Click this to move all parts in the Whole Hands tab.

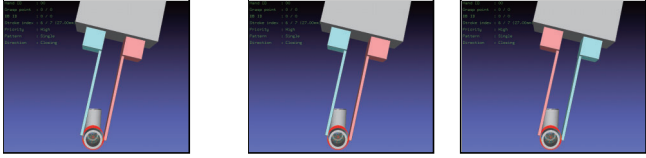
• Whole Hands tab

Make the settings of the whole hand.

Setting item	Setting value [Factory default]	Description
Hand ID	0 to 10,000 [0]	Set the hand ID to identify the hand data.
Margin [mm]	0.0 to 10,000.0 [1.0]	Set the margin for collision detection between the CAD data for the workpiece and the hand model, which is used during grasp registration in the grasp registration tool GraspTechGUI . By using a hand with a margin and registering its grasp point, you can register safe poses of grasping that allow for hand creation errors, etc.

Setting item	Setting value [Factory default]	Description				
Symmetry	<ul style="list-style-type: none"> • Checked • [Unchecked] 	<p>Set whether the hand has rotational symmetry around the Z axis.</p> <p>If this is checked, collision detection is performed for each pose of grasping by taking into account the rotational symmetry when it is calculated in the Grasp Planning processing item. This makes it unnecessary to register the grasp point after rotation in the grasp registration tool GraspTeachGUI.</p> <p>Example: Angle [deg] = 180.0</p> <table border="0"> <tr> <td>Checked</td> <td>Unchecked</td> </tr> <tr> <td>Grasp point: only one point</td> <td>Grasp point: two points required</td> </tr> </table> 	Checked	Unchecked	Grasp point: only one point	Grasp point: two points required
Checked	Unchecked					
Grasp point: only one point	Grasp point: two points required					
Angle [deg]	0.0 to 180.0 [0.0]	This setting is enabled only when Symmetry is checked. Set the angle of symmetry around the Z axis.				
Stroke		<p>Set the opening width of the left and right fingers for grasp registration in the GraspTeachGUI grasp registration tool.</p> <p>You can adjust the opening widths of the fingers used for grasp registration in the GraspTeachGUI as much as the amount that you added to the stroke list.</p> <p>By adjusting the opening width, you can register poses of grasping appropriate for the shape of the workpiece, even for workpieces with different thicknesses.</p> <p>The distance between the left and right fingers for grasp registration is “Stroke (opening width) + Distance when parts are placed.” That is, the opening width is 0 mm when parts are placed.</p> <p>Example:</p> <table border="0"> <tr> <td>When parts are placed</td> <td>Stroke (opening width) + Distance when parts are placed</td> </tr> <tr> <td></td> <td></td> </tr> </table>	When parts are placed	Stroke (opening width) + Distance when parts are placed		
When parts are placed	Stroke (opening width) + Distance when parts are placed					
						
Direction	<ul style="list-style-type: none"> • X • [Y] 	<p>Set the opening and closing direction of the left and right fingers.</p> <p>Check the hand coordinate system and set them in the correct direction.</p>				
Max Stroke [mm]	0.0 to 10,000.0 [50.0]	<p>Set the maximum opening width of the left and right fingers.</p> <p>You cannot set this to smaller than the value in the stroke list shown on the right and the set value of Add Stroke.</p>				

Setting item	Setting value [Factory default]	Description
Initial Index	0 to 127 [3]	Select the default index of the opening width in the grasp registration tool GraspTeachGUI . You cannot set this to larger than the number of rows of the stroke list shown on the right.
Add Stroke [mm]	0.0 to 10,000.0 [0.0]	Set the opening width to add to the stroke list shown on the right. You cannot set this to larger than the set value of Max Stroke .
Add	-	Click this to add the set value of Add Stroke to the stroke list shown on the right. You can add up to 128 parts to the list. Alternatively, you can double-click on the stroke list to directly edit the opening width setting of the hand.
Delete	-	Click this to delete the selected row from the stroke list shown on the right.

d) Image view area

The hand that you are creating is displayed in 3D.

The display color varies depending on the part type. (Base: Gray, Left finger/Left tip finger: Red, Right finger/Right tip finger: Blue)

The wireframe of the selected part in the part list view is highlighted in yellow in the image display area.

Operation	Description
Left-click + Drag	You can move the viewpoint by rotating the image around the origin of the hand (i.e., the origin of the X, Y, and Z axes displayed in the image display area).
Mouse wheel scroll	You can zoom in and out the image around the origin of the hand. The image can be zoomed in and out 0.01 to 3 times, where the magnification set when the Reset Display button is clicked defined as 1.
Middle click + Drag or Shift key + Left-click + Drag	You can move the hand. The hand can be moved within the range in which the hand position XYZ can be expressed in double-precision floating point.

The hand size is displayed in green text.

Item	Description
Total size [mm]	The overall hand size is displayed.
X	
Y	
Z	

e) Image display method selection area

Item	Description
<ul style="list-style-type: none"> Coloring in All Parts Coloring in Selected Parts No Coloring 	<ul style="list-style-type: none"> Coloring in All Parts: All parts are displayed as polygons. Coloring in Selected Parts: Only the selected part is displayed as polygons. Other parts are displayed as a wireframe. No Coloring: All parts are displayed as a wireframe.
Display Bounding Rectangle / Size	Check this to display the circumscribed cube of the hand as a wireframe in the image display area, together with its size information.

Item	Description
Reset Display	Reset the viewpoint of the image display area to the initial position.

f) Others

Item	Description
Save	Save the hand data that you are creating. If there are missing part list components, you cannot save the data.
Exit	Close the HandMaker dialog. If the data is not yet saved, a dialog is displayed, asking whether to save the data.

- 6** When the saving of the data is completed, the name and size of the created hand data are displayed. You can click the **Edit** button to edit the created hand data in the **HandMaker** dialog. In the area on the right, the definition information of the hand data is displayed. You cannot edit it here.

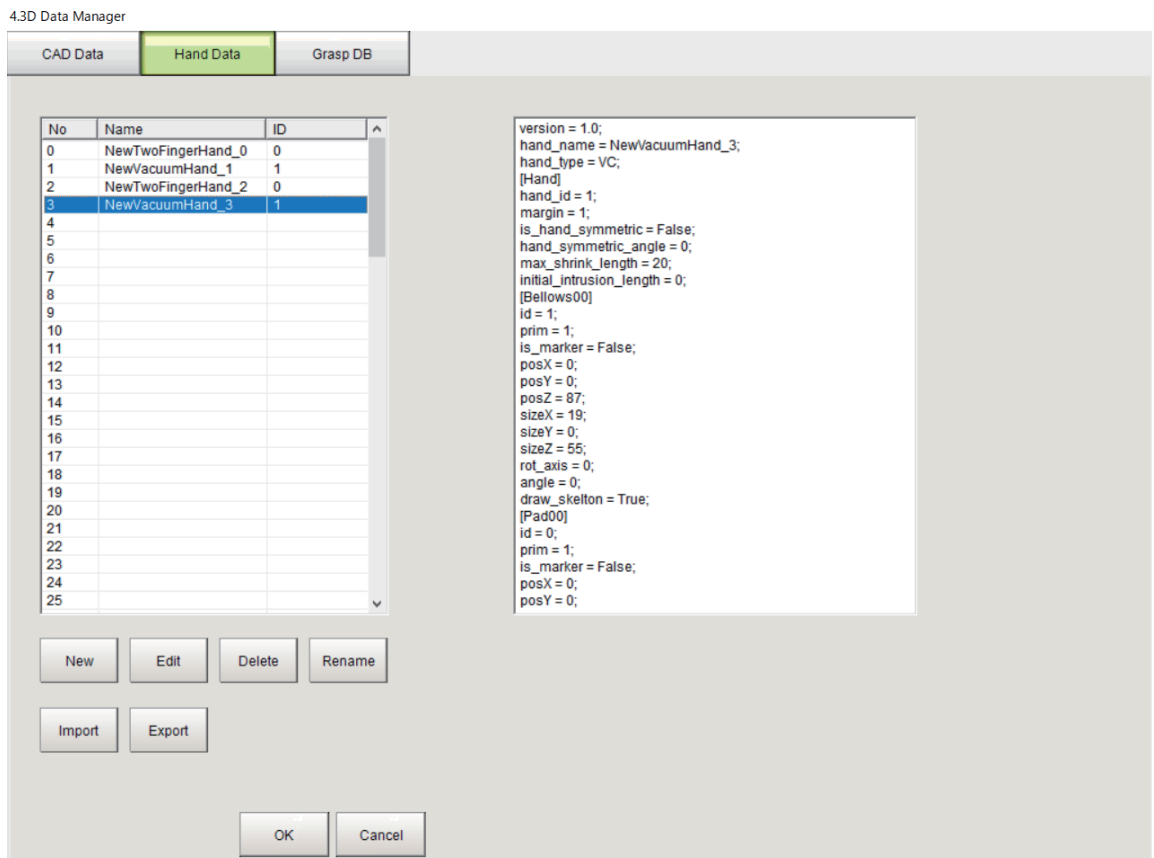

- 7** If necessary, click the **Rename** button and change the name.
- 8** You can click the **Export** button to save the created hand data to a file. In addition, you can click the **Import** button to import a saved hand data file.



Precautions for Correct Use

If the file path contains 256 characters or more, the data cannot be loaded.

One-point Vacuum Hand

- 1 In the Item tab area, click the **Hand Data** tab.

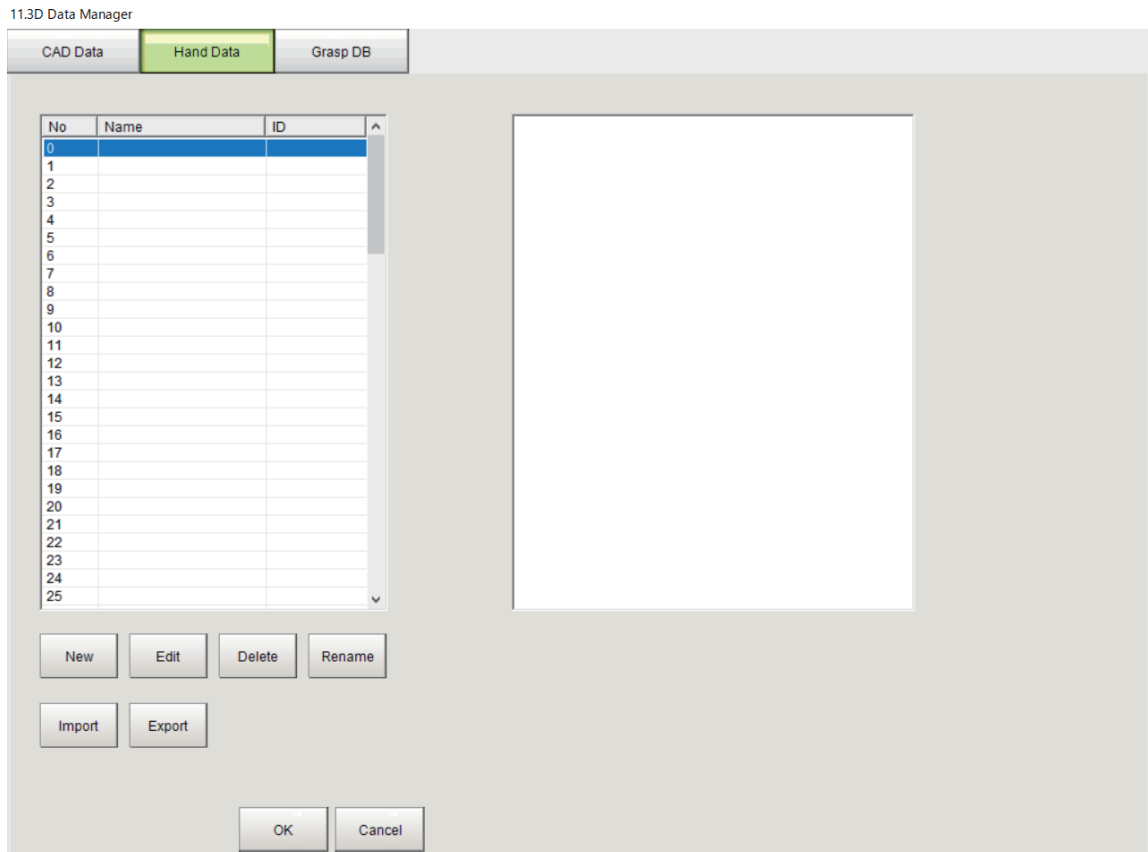

- 2 Select the number of the line in which to add hand data.
The background color of the selected line changes.
You can set up to 100 data items.
To add data to a line number with set data, click the **Delete** button to delete the set data.
- 3 Click the **New** button. You will create the hand data in the **HandMaker** dialog.
- 4 The **Create New** dialog is displayed. As the hand type, select *One-point Vacuum*. Set the hand ID and click **OK**.

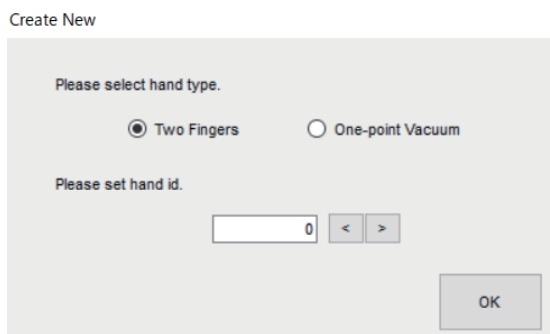

Setting item	Setting value [Factory default]	Description
Hand type	<ul style="list-style-type: none"> [Two Fingers] One-point Vacuum 	Select the type of the hand data to create.
Hand ID	0 to 10,000 [0]	Set the hand ID.

5 Create the hand data in the **HandMaker** dialog.

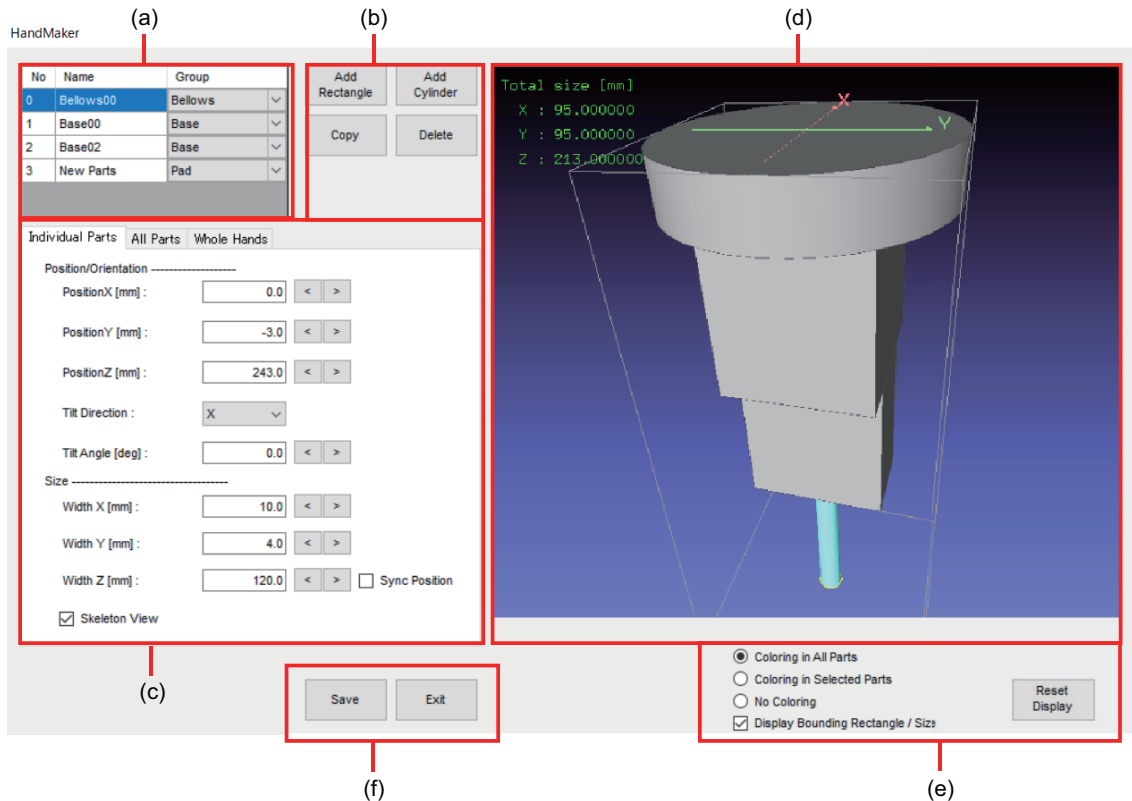

a) Part list view

The names and groups of hand parts are listed. Select the part to edit or display from the list.

You can add up to 128 parts to the list. The sort and filter functions are not available.

To change the part name, double-click it in the **Name** column.

To change the group, click it in the **Group** column.

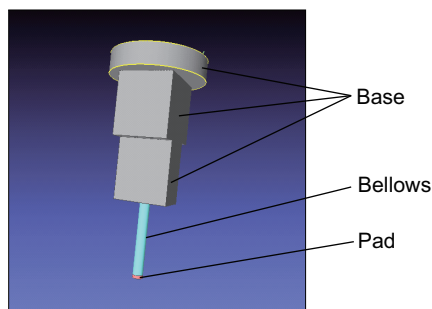

Item	Description
Pad	Pad part. This performs sucking. You can set only one part. It is displayed in red.

Item	Description
Bellows	Bellows part. This performs sucking. You must register only one part. It is displayed in light blue.
Base	Base parts. These are fixed. You can set up to 64 parts. You must register at least one part. It is displayed in gray.

The wireframe of the selected part in the part list view is highlighted in yellow in the image display area.

b) Operation button

Item	Description
Add Ractangle	Add a rectangle to the end of the part list view.
Add Cylinder	Add a cylinder to the end of the part list view.
Copy	Add a copy of the selected part in the part list view to the end of the list. The changed name cannot be copied.
Delete	Delete the part selected in the parts list view from the list.

c) Setting tab area

• Individual Parts tab

Set the position/posture and size of the selected part in the part list view.

For rectangles

For cylinders

Setting item	Setting value [Factory default]	Description
Position X [mm]	-10,000.0 to 10,000.0 [0.0]	Set the position in which to place the part.
Position Y [mm]	-10,000.0 to 10,000.0 [0.0]	
Position Z [mm]	-10,000.0 to 10,000.0 [0.0]	
Tilt Direction	<ul style="list-style-type: none"> • [X] • Y • Z 	Set the reference axis around which to rotate the part.
Tilt Angle [deg]	-180.0 to 180.0 [0.0]	Set the rotation angle of the part.

Setting item	Setting value [Factory default]	Description
Width X [mm]	1.0 to 10,000.0 [10.0]	These items are displayed for rectangle parts only. Set the size of the rectangular part.
Width Y [mm]	1.0 to 10,000.0 [10.0]	
Width Z [mm]	1.0 to 10,000.0 [10.0]	
Diameter [mm]	1.0 to 10,000.0 [30.0]	These items are displayed for cylinder parts only. Set the size of the cylinder part.
Height [mm]	1.0 to 10,000.0 [10.0]	
Sync Position	<ul style="list-style-type: none"> • Checked • [Unchecked] 	Check this to fix the top of the part (position in the negative Z direction) when the Width Z or Height setting is changed.
Skeleton View	<ul style="list-style-type: none"> • [Checked] • Unchecked 	Check this to display the selected part as a skeleton when the Skeleton View is enabled in the grasp registration tool GraspTeachGUI .

- All Parts tab
Move all parts at once.

Individual Parts All Parts Whole Hands

Group -----

Move

Direction :

Amount of Movement [mm] :

Setting item	Setting value [Factory default]	Description
Move	<ul style="list-style-type: none"> • Pad • Bellows • Base 	Select the part group to move.
Direction	<ul style="list-style-type: none"> • [X] • Y 	Set the axis along which to move the part.
Amount of Movement [mm]	-10,000.0 to 10,000.0 [0]	Set the distance to move the part in one click of Execute .
Execute	-	Click this to move all parts in the Whole Hands tab.

- Whole Hands tab
Make the settings of the whole hand.

Individual Parts | All Parts | Whole Hands

Hand ID : < >

Margin [mm] : < >

Symmetry Angle [deg] : < >

Push-in Amount of Grip Teach [mm]: < >

Max Bellows Contraction [mm] : < >

Setting item	Setting value [Factory default]	Description
Hand ID	0 to 10,000 [0]	Set the hand ID to identify the hand data.
Margin [mm]	0.0 to 10,000.0 [1.0]	Set the margin for collision detection between the CAD data for the workpiece and the hand model, which is used during grasp registration in the grasp registration tool GraspTeachGUI . By using a hand with a margin and registering its grasp point, you can register safe poses of grasping that allow for hand creation errors, etc.
Symmetry	<ul style="list-style-type: none"> • Checked • [Unchecked] 	Set whether the hand has rotational symmetry around the Z axis. If this is checked, collision detection is performed for each pose of grasping by taking into account the rotational symmetry when it is calculated in the Grasp Planning processing item. This makes it unnecessary to register the grasp point after rotation in the grasp registration tool GraspTeachGUI .
Angle [deg]	0.0 to 180.0 [0.0]	This setting is enabled only when Symmetry is checked. Set the angle of symmetry around the Z axis.
Push-in Amount of Grip Teach [mm]	0.0 to 10,000.0 [0.0]	Specify the initial position of the vacuum hand when a new grasp point is added in the grasp registration tool GraspTeachGUI . If this is set to 0.0, the vacuum hand will be positioned so that its tip is on the workpiece surface. If this is not 0.0, the vacuum hand will be positioned so that its tip is pushed into the workpiece surface by a specified amount. Because a Bellows part contracts, it is necessary to register poses of grasping in which the tip of the hand is slightly pushed into the workpiece. If you use a hand with the maximum amount of contraction of the Bellows part is 10 mm or more, set a value of approximately 1 to 3 mm as a guide. If you use a hand that has a small amount of play with the maximum amount of contraction of the Bellows part is 3 mm or less, you need to adjust the push-in amount to approximately 0.5 mm. You cannot set this to greater than the Max Bellows Contraction value.

Setting item	Setting value [Factory default]	Description
Max Bellows Contraction [mm]	0.0 to 10,000.0 [20.0]	Set the amount of contraction for Bellows parts. You cannot set this to smaller than the Push-in Amount of Grip Teach value.

d) Image view area

The hand that you are creating is displayed in 3D.

The display color varies depending on the part type. (Base: Gray, Pad: Red, Bellows: Cyan)

The wireframe of the selected part in the part list view is highlighted in yellow in the image display area.

Operation	Description
Left-click + Drag	You can move the viewpoint by rotating the image around the origin of the hand (i.e., the origin of the X, Y, and Z axes displayed in the image display area).
Mouse wheel scroll	You can zoom in and out the image around the origin of the hand. The image can be zoomed in and out 0.01 to 3 times, where the magnification set when the Reset Display button is clicked defined as 1.
Middle click + Drag or Shift key + Left-click + Drag	You can move the hand. The hand can be moved within the range in which the hand position XYZ can be expressed in double-precision floating point.

The hand size is displayed in green text.

Item	Description
Total size [mm]	The overall hand size is displayed.
X	
Y	
Z	

e) Image display method selection area

Item	Description
<ul style="list-style-type: none"> • Coloring in All Parts • Coloring in Selected Parts • No Coloring 	<ul style="list-style-type: none"> • Coloring in All Parts: All parts are displayed as polygons. • Coloring in Selected Parts: Only the selected part is displayed as polygons. Other parts are displayed as a wireframe. • No Coloring: All parts are displayed as a wireframe.
Display Bounding Rectangle / Size	Check this to display the circumscribed cube of the hand as a wireframe in the image display area, together with its size information.
Reset Display	Reset the viewpoint of the image display area to the initial position.

f) Others

Item	Description
Save	Save the hand data that you are creating. If there are missing part list components, you cannot save the data.
Exit	Close the HandMaker dialog. If the data is not yet saved, a dialog is displayed, asking whether to save the data.

- 6** When the saving of the data is completed, the name and size of the created hand data are displayed. You can click the **Edit** button to edit the created hand data in the **HandMaker** dialog. In the area on the right, the definition information of the hand data is displayed. You cannot edit it here.

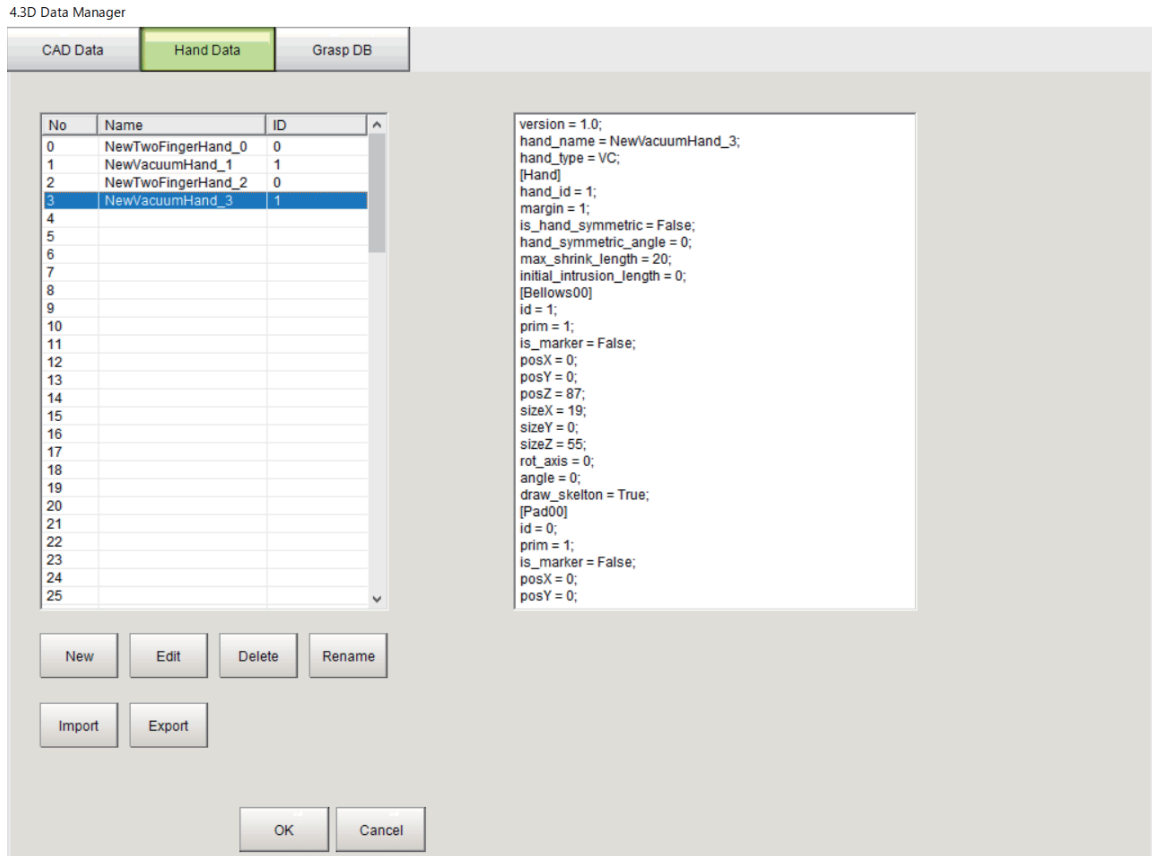

- 7 If necessary, click the **Rename** button and change the name.
- 8 You can click the **Export** button to save the created hand data to a file. In addition, you can click the **Import** button to import a saved hand data file.



Precautions for Correct Use

If the file path contains 256 characters or more, the data cannot be loaded.

4-2-3 Grasp DB (3D Data Manager)

Register the position and pose of the hand to grasp the workpiece and generate the grasp pose data (grasp DB data) to be held in this processing item.

For the CAD data for the target workpiece, set the grasp point and the poses of grasping with respect to the grasp point.

Example:

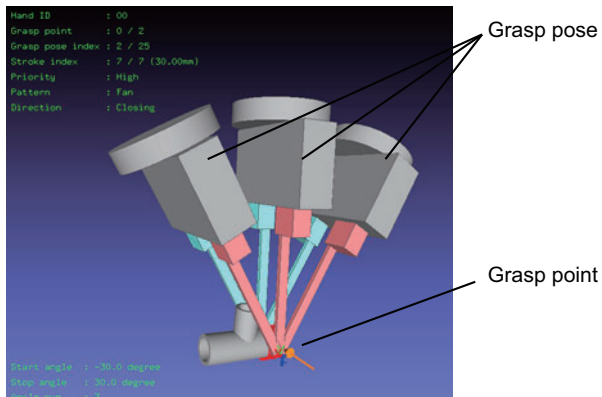

Precautions for Correct Use

- When you edit hand data, the changed shapes and positions are not reflected in the grasp DB. Edit the hand data in the grasp DB as well.



Additional Information

- Registering redundant poses of grasping results in increased processing time. Register the minimum required number of poses of grasping. In addition, if there are many variations in the posture of the workpiece or if the hand is not symmetrical, registering a small number of poses of grasping results in a small number of grasp candidates. Register the minimum required number of poses of grasping, taking into account the variations in the posture.
- The poses of grasping must be set considering how the workpiece is placed after it is grasped. If it is difficult to place the workpiece directly, you need to consider placing it temporarily and re-grasping it.

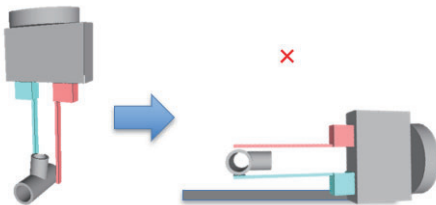

Using automatic registration to register poses of grasping by pattern may result in registering a pose of grasping in which directly placing the workpiece is difficult.

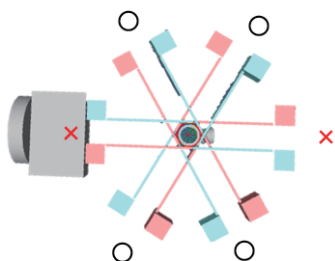

Two-finger Hand

- In the Item tab area, click the **Grasp DB** tab.

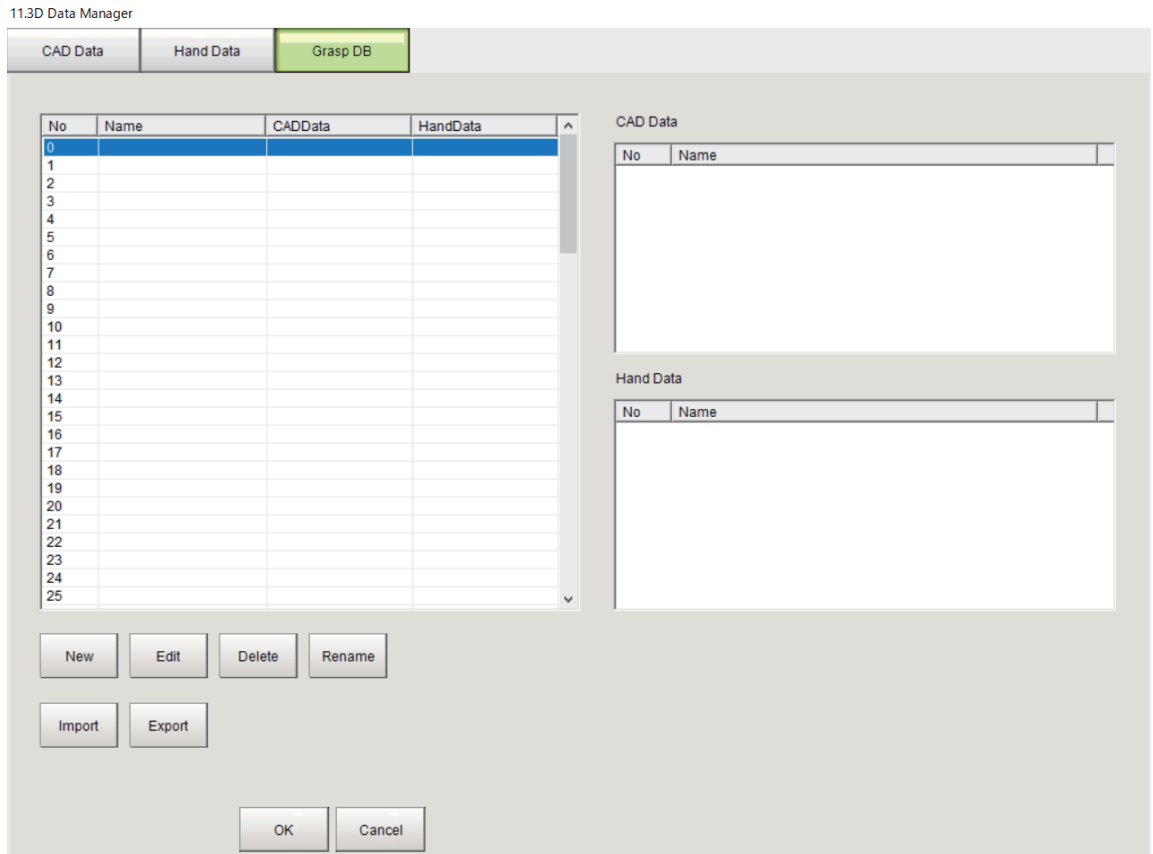

- 2** Select the number of the line in which to register the grasp point and set the grasp DB. The background color of the selected line changes. You can set up to 100 data items. To add data to a line number with set data, click the **Delete** button to delete the set data.
- 3** From the list of CAD data displayed in the **CAD Data** area, select the data from which to register the grasp point. The data set in the **CAD Data** tab is listed. The background color of the selected line changes.
- 4** From the list of hand data displayed in the **Hand Data** area, select the data to use for grasping. The data set in the **Hand Data** tab is listed. The background color of the selected line changes.
- 5** Click the **New** button and register the grasp point in the grasp registration tool **GraspTeachGUI**.
- 6** In the **GraspTeachGUI**, register the grasp point. Right-click two points on the workpiece image to add a grasp point, and then set it.

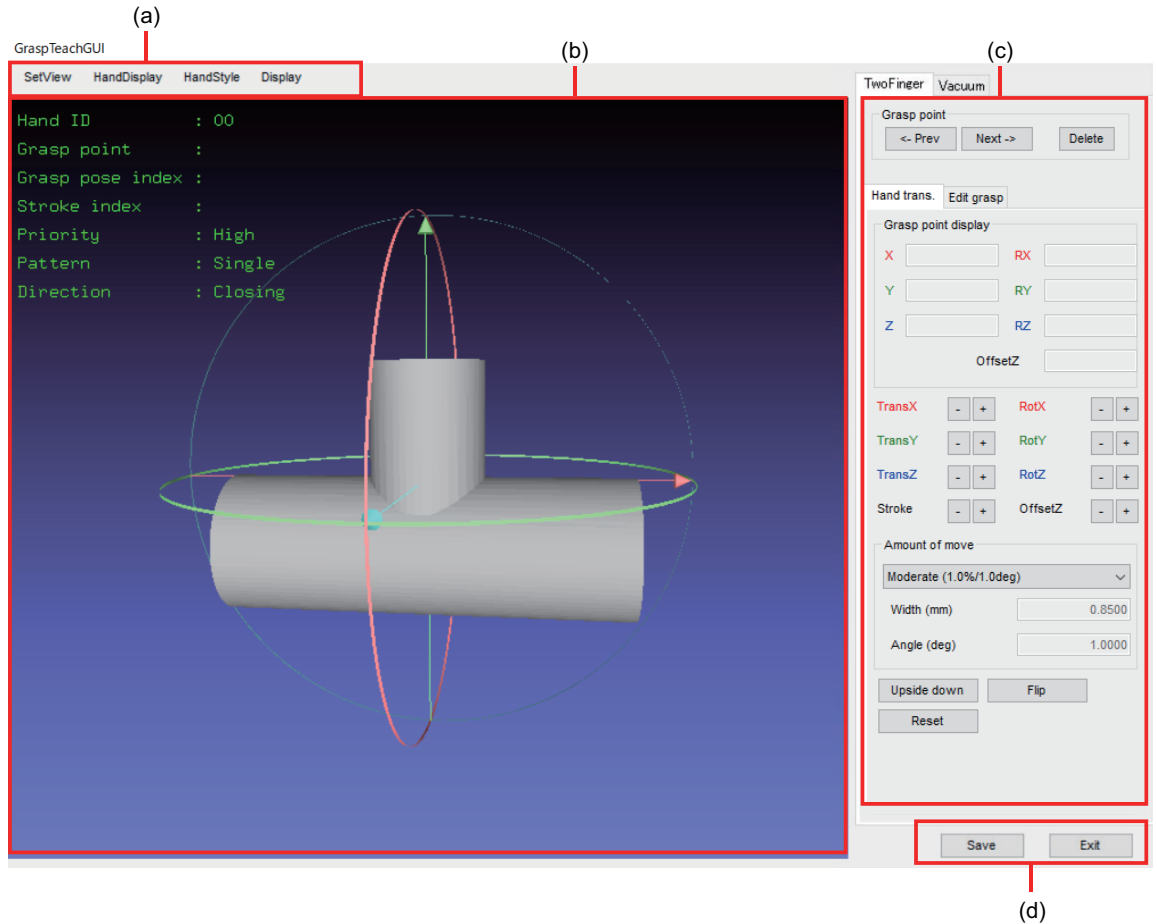

a) Display menu

Setting item	Setting value [Factory default]	Description
SetView	<ul style="list-style-type: none"> • Front side • Back side • Left side • Right side • Top side • Bottom side 	Change the viewpoint of the image display area.
HandDisplay	<ul style="list-style-type: none"> • [Selected] • All • None 	Specify the hands to display. <ul style="list-style-type: none"> • Selected: The currently selected hand is displayed. • All: All hands are displayed. • None: No hand is displayed.
HandStyle	<ul style="list-style-type: none"> • [Normal] • Fat • Skeleton 	Change the hand style. <ul style="list-style-type: none"> • Fat: The hand that is inflated by a margin is displayed. Use this setting for collision detection. • Skeleton: The hand is displayed as a skeleton. Use this setting if the hand is overlapped and difficult to see.
Display		Change the display of workpiece and guide information.

Setting item	Setting value [Factory default]	Description
Object polygon	<ul style="list-style-type: none"> • [Checked] • Unchecked 	The workpiece is displayed as polygons.
Object wire-frame	<ul style="list-style-type: none"> • Checked • [Unchecked] 	The workpiece is displayed as a wireframe. Use this to check the mesh size. There is no need to set it normally.
Object point cloud	<ul style="list-style-type: none"> • Checked • [Unchecked] 	Point clouds for collision detection are displayed. There is no need to set it normally.
Object Axis	<ul style="list-style-type: none"> • [Checked] • Unchecked 	The coordinate axes of the workpiece are displayed.
Tool Axis	<ul style="list-style-type: none"> • [Checked] • Unchecked 	The coordinate axes of the tool are displayed.

b) Image views areas

The workpiece, hand, and grasp point are displayed in 3D.

In the image display area, right-click two points on the workpiece to add a grasp point. A hand appears at the center of the two points.

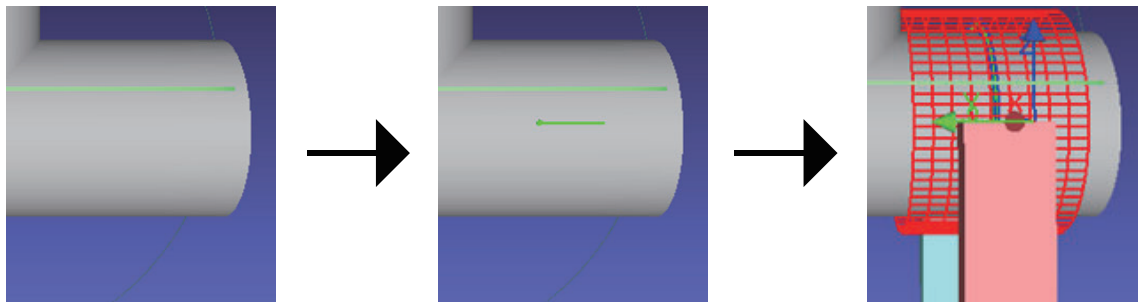

Operation	Description
Right-click two points on the workpiece.	You can add a grasp point by right-clicking two points on the workpiece. You cannot add more than 128 grasp points.
Left-click + Drag	You can move the viewpoint by rotating the image around the origin of the object coordinate axes (i.e., the origin of the X, Y, and Z axes displayed in the image display area).
Mouse wheel scroll	You can zoom in and out the image around the origin of the object coordinate axes.
Middle click + Drag or Shift key + Left-click + Drag	You can move the workpiece.

If the workpiece collides with the hand, the finger parts (Left finger, Left tip finger, Right finger, Right tip finger) are displayed in yellow.

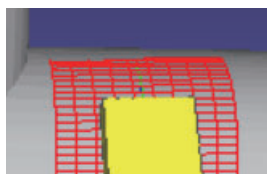

The grasp information is displayed in green text.

It is displayed at the upper left of the image display area.

Item	Description
Hand ID	The Hand ID of the hand data set in HandMaker is displayed.

Item	Description
Grasp point	The number of the currently displayed grasp (registration) point and the total number of registered grasp (registration) points are displayed, separated by a slash (/).
Grasp pose index	The number of the currently displayed pose of grasping and the total number of poses of grasping in the grasp DB are displayed, separated by a slash (/). This item does not reflect the poses of grasping that were not regarded as valid due to a collision between the hand and the workpiece since they are not assigned grasping pose numbers.
Stroke index	The current set value and maximum value of Stroke (the Stroke settings in mm) are displayed, separated by a slash (/).
Priority	The Priority setting is displayed.
Pattern	The Pattern setting is displayed.
Direction	The Direction setting is displayed.

It is displayed at the bottom left of the image display area.

Item	Description
Start angle	This item is displayed when Pattern is set to <i>Fan</i> , <i>Cylinder</i> , or <i>Circle</i> . The Start angle setting is displayed.
Stop angle	This item is displayed when Pattern is set to <i>Fan</i> , <i>Cylinder</i> , or <i>Circle</i> . The Stop angle setting is displayed.
Angle num	This item is displayed when Pattern is set to <i>Fan</i> , <i>Cylinder</i> , or <i>Circle</i> . The Angle num setting is displayed.
Fan angle num	This item is displayed when Pattern is set to <i>Hybrid</i> . The Num angle setting when Pattern is set to <i>Fan</i> is displayed.
Cylinder angle num	This item is displayed when Pattern is set to <i>Hybrid</i> . The Num angle setting when Pattern is set to <i>Cylinder</i> is displayed.

c) Grasping pose setting area

Adjust the position and posture of added grasp points, or edit the grasp points.

- Grasp point

Item	Description
Prev	Display the previous grasp point.
Next	Display the next grasp point.
Delete	Delete the currently displayed grasp point.

- Hand transformation

Item	Description
Grasp point display X	The hand position/posture of the grasp point is displayed in the CAD coordinate system. The numeric values can be directly input and adjusted.
Grasp point display Y	
Grasp point display Z	
Grasp point display RX	
Grasp point display RY	
Grasp point display RZ	
Grasp point display OffsetZ	
TransX -/+	Translate the hand in the tool coordinate system.
TransY -/+	
TransZ -/+	

Item	Description
RotX +/-	Rotate the hand in the tool coordinate system.
RotY +/-	
RotZ +/-	
Stroke +/-	Adjust the opening width of the hand. The set value is displayed as Stroke index in the image display area.
Offset Z +/-	Adjust the Z-axis offset angle. Translate the hand in the tool coordinate system. The guide does not move.
Precise (0.1% / 0.1deg) Moderate (1.0% / 1.0deg) Rough (5.0% / 5.0deg) Very rough (30.0% / 30.0deg) Numerical input	Set the amount of movement per translation, rotation, or Z offset operation.
Width (mm) Angle (deg)	The set amount of movement is displayed. If set to <i>Numerical Input</i> , the numeric value is directly input and set.
Upside down	Flip the hand upside and down.
Flip	Flip the hand back and forth.
Reset	Reset the hand position. Return to the state when you added the grasp point by right-clicking.

- Edit grasp

Item	Description
Pattern	Set a grasp pattern that allows the registration of multiple poses of grasping at once. <ul style="list-style-type: none"> Single: Register the poses of grasping one by one. Fan: Register the poses of grasping at a time in a fan-shaped swing pattern by rotating the hand. Cylinder: Register the poses of grasping at a time in a cylindrical swing pattern by rotating the hand in the approach direction. Hybrid: Register the poses of grasping at a time in a combined grasp pattern of <i>Fan</i> and <i>Cylinder</i>. Circle: Register the poses of grasping at a time in a circular swing pattern by rotating the hand in a circumferential direction.
Start angle +/-	Adjust the start angle when Pattern is not set to <i>Single</i> . The set value is displayed in the lower left of the image area.
Stop angle +/-	Adjust the stop angle when Pattern is not set to <i>Single</i> . The set value is displayed in the lower left of the image area.
Num angle +/-	Adjust the number of angle divisions when Pattern is not set to <i>Single</i> . The set value is displayed in the lower left of the image area.
Precise (0.1deg) Moderate (1.0deg) Rough (5.0deg)	Set the amount of change in the start angle and stop angle per adjustment when Pattern is not set to <i>Single</i> .
Copy current grasp	Copy and add the current grasp point.

Item	Description
Guide	<p>Change the displayed guide.</p> <ul style="list-style-type: none"> • Cylinder: Cylinder guide • Rectangle: Rectangle guide • Plane: Plane guide • None: No guide <p>If Pattern is set to <i>Cylinder</i> or <i>Hybrid</i>, the plane guide is displayed regardless of the Guide setting.</p> <p>If Pattern is set to <i>Circle</i>, the plane guide is displayed regardless of the Guide setting.</p>
Priority	<p>Set the priority (rank) of the grasp point that is used when calculating the Grasping grade in the Grasp Planning processing item.</p> <p>In the calculation of the Grasping grade in the Grasp Planning processing item, the overall grasping grade, including the posture of the hand and the distance to the workpiece during grasping, is calculated. For example, even if the priority of a grasp point is set to <i>Low</i>, the grasp point may be calculated lower than (superior in grade to) another grasp point that is set to <i>High</i>.</p> <ul style="list-style-type: none"> • High: Rank A • Low: Rank B, the Grasping grade is greater than 1 (B1).
Direction	<p>Set the opening and closing direction of the hand during grasping.</p> <ul style="list-style-type: none"> • Closing • Opening

d) Others

Item	Description
Save	Save the created grasp pose data. If the pose of grasping is not registered, or if there is an error in the grasping pose settings, the data cannot be saved.
Exit	Close the grasp registration tool GraspTeachGUI . If the data is not yet saved, a dialog is displayed, asking whether to save the data.

- 7** When the save of the data is completed, the name of the created grasp pose data and the names of the CAD data and hand data used are displayed. You can click the **Edit** button to edit the created grasp pose data in the grasp registration tool **GraspTeachGUI** dialog.

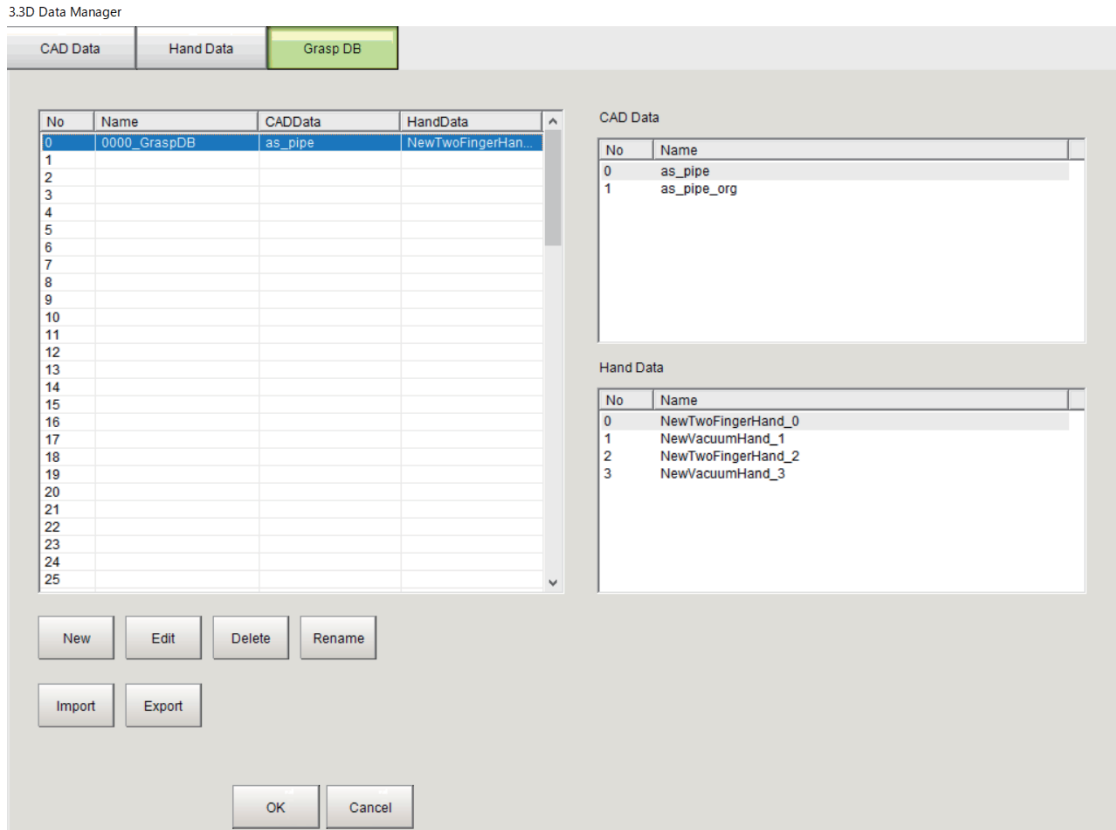

- 8 If necessary, click the **Rename** button and change the name.
- 9 You can click the **Export** button to save the created grasp pose data to a file. In addition, you can click on the **Import** button to load the saved grasp pose data file.



Precautions for Correct Use

If the file path contains 256 characters or more, the data cannot be loaded.

One-point Vacuum Hand

- 1 In the Item tab area, click the **Grasp DB** tab.

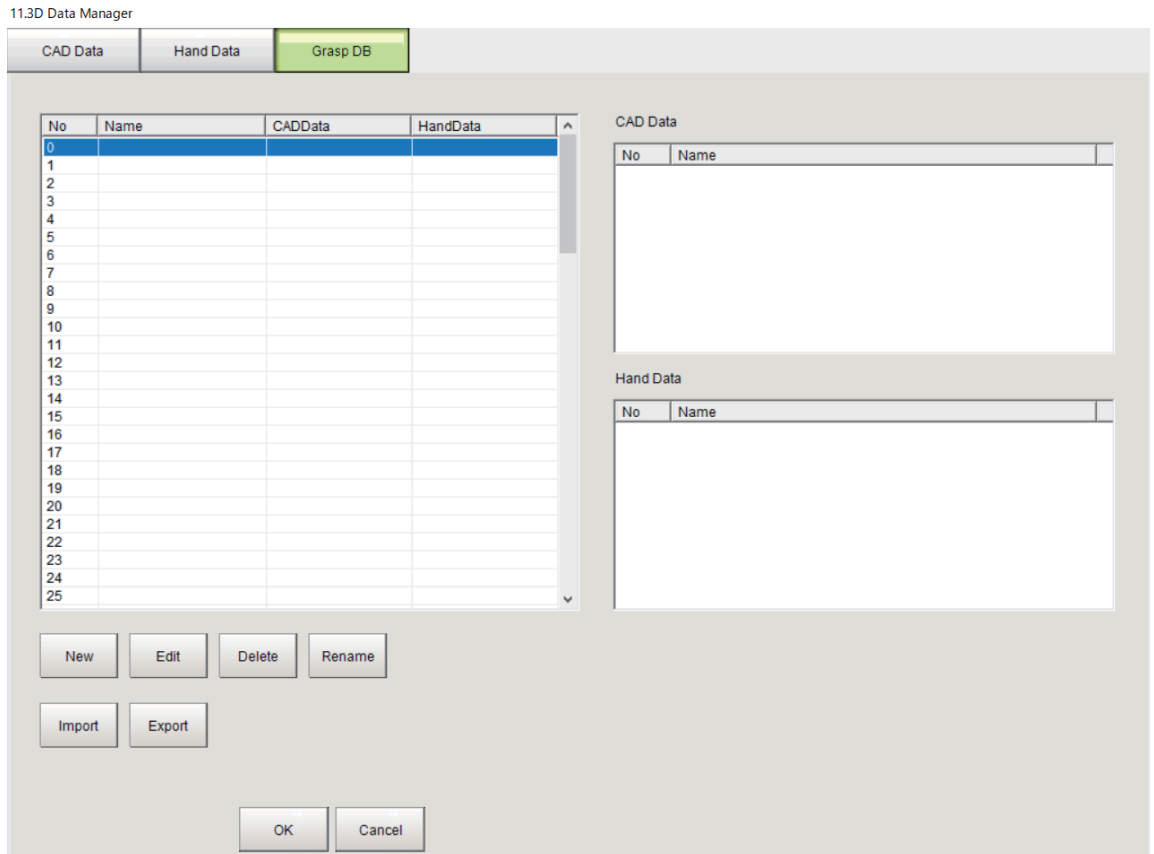

- 2** Select the number of the line in which to register the grasp point and set the grasp DB. The background color of the selected line changes. You can set up to 100 data items. To add data to a line number with set data, click the **Delete** button to delete the set data.
- 3** From the list of CAD data displayed in the **CAD Data** area, select the data from which to register the grasp point. The data set in the **CAD Data** tab is listed. The background color of the selected line changes.
- 4** From the list of hand data displayed in the **Hand Data** area, select the data to use for grasping. The data set in the **Hand Data** tab is listed. The background color of the selected line changes.
- 5** Click the **New** button and register the grasp point in the grasp registration tool **GraspTeachGUI**.
- 6** In the **GraspTeachGUI**, register the grasp point. Right-click on the workpiece image to add a grasp point, and then set it.

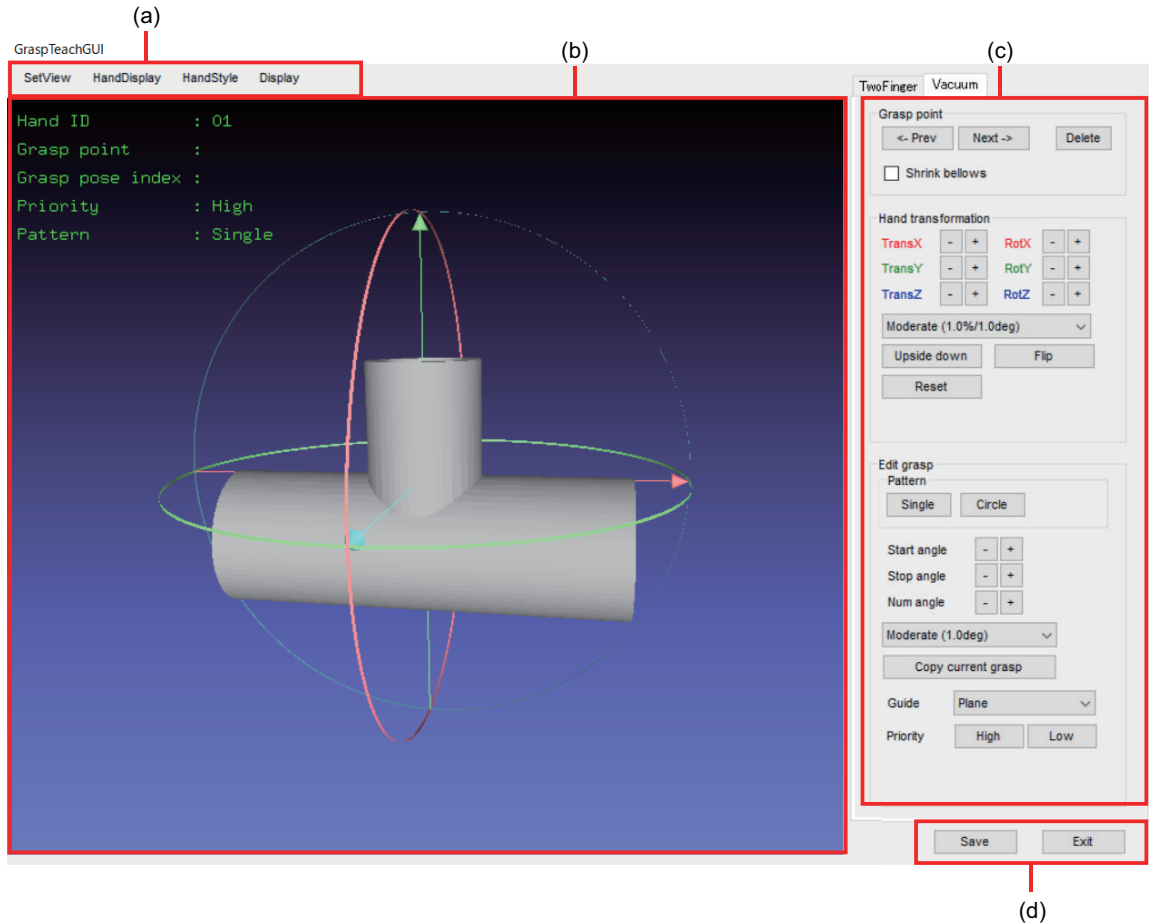

a) Display menu

Setting item	Setting value [Factory default]	Description
SetView	<ul style="list-style-type: none"> • Front side • Back side • Left side • Right side • Top side • Bottom side 	Change the viewpoint of the image display area.
HandDisplay	<ul style="list-style-type: none"> • [Selected] • All • None 	Specify the hands to display. <ul style="list-style-type: none"> • Selected: The currently selected hand is displayed. • All: All hands are displayed. • None: No hand is displayed.
HandStyle	<ul style="list-style-type: none"> • [Normal] • Fat • Skeleton 	Change the hand style. <ul style="list-style-type: none"> • Fat: The hand that is inflated by a margin is displayed. Use this setting for collision detection. • Skeleton: The hand is displayed as a skeleton. Use this setting if the hand is overlapped and difficult to see.
Display		Change the display of workpiece and guide information.

Setting item	Setting value [Factory default]	Description
Object poly- gon	<ul style="list-style-type: none"> • [Checked] • Unchecked 	The workpiece is displayed as polygons.
Object wire- frame	<ul style="list-style-type: none"> • Checked • [Unchecked] 	The workpiece is displayed as a wireframe. Use this to check the mesh size. There is no need to set it normally.
Object point cloud	<ul style="list-style-type: none"> • Checked • [Unchecked] 	Point clouds for collision detection are displayed. There is no need to set it normally.
Object Axis	<ul style="list-style-type: none"> • [Checked] • Unchecked 	The coordinate axes of the workpiece are displayed.
Tool Axis	<ul style="list-style-type: none"> • [Checked] • Unchecked 	The coordinate axes of the tool are displayed.

b) Image views areas

The workpiece, hand, and grasp point are displayed in 3D.

In the image display area, right-click on the workpiece to add a grasp point. The hand is displayed in the position where you right-clicked.

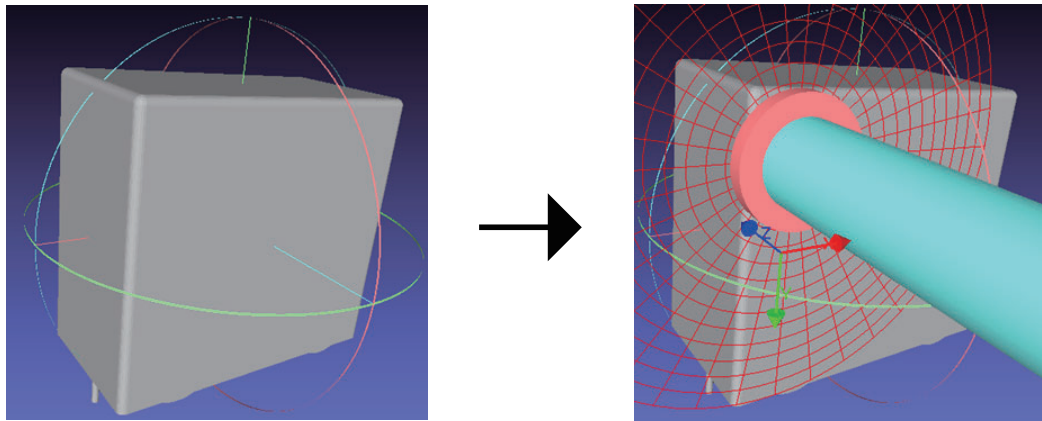

Operation	Description
Right-click on the workpiece.	You can add a grasp point by right-clicking on the workpiece. You cannot add more than 128 grasp points.
Left-click + Drag	You can move the viewpoint by rotating the image around the origin of the object coordinate axes (i.e., the origin of the X, Y, and Z axes displayed in the image display area).
Mouse wheel scroll	You can zoom in and out the image around the origin of the object coordinate axes.
Middle click + Drag or Shift key + Left-click + Drag	You can move the workpiece.

If the workpiece collides with the hand, the finger parts (Pad and Bellows) are displayed in yellow.

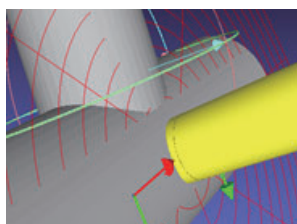

The grasp information is displayed in green text.

It is displayed at the upper left of the image display area.

Item	Description
Hand ID	The Hand ID of the hand data set in HandMaker is displayed.
Grasp point	The number of the currently displayed grasp (registration) point and the total number of registered grasp (registration) points are displayed, separated by a slash (/).
Grasp pose index	The number of the currently displayed pose of grasping and the total number of poses of grasping in the grasp DB are displayed, separated by a slash (/). This item does not reflect the poses of grasping that were not regarded as valid due to a collision between the hand and the workpiece since they are not assigned grasping pose numbers.
Priority	The Priority setting is displayed.
Pattern	The Pattern setting is displayed.

It is displayed at the bottom left of the image display area.

Item	Description
Start angle	This item is displayed when Pattern is set to <i>Circle</i> . The Start angle setting is displayed.
Stop angle	This item is displayed when Pattern is set to <i>Circle</i> . The Stop angle setting is displayed.
Angle num	This item is displayed when Pattern is set to <i>Circle</i> . The Angle num setting is displayed.

c) Grasping pose setting area

Adjust the position and posture of added grasp points, or edit the grasp points.

- Grasp point

Item	Description
Prev	Display the previous grasp point.
Next	Display the next grasp point.
Delete	Delete the currently displayed grasp point.
Shrink bellows	Switch the Bellows part between extended and contracted states. Check this to display it in a contracted state. Check this to display it in an extended state. For the Bellows part, no collision is detected only if it does not collide in a contracted state.

- Hand transformation

Item	Description
TransX -/+	Translate the hand in the tool coordinate system.
TransY -/+	
TransZ -/+	
RotX -/+	Rotate the hand in the tool coordinate system.
RotY -/+	
RotZ -/+	
Precise (0.1% / 0.1deg) Moderate (1.0% / 1.0deg) Rough (5.0% / 5.0deg) Very rough (30.0% / 30.0deg) Numerical input	Set the amount of movement per translation or rotation operation.

Item	Description
Width (mm)	The set amount of movement is displayed.
Angle (deg)	If set to <i>Numerical Input</i> , the numeric value is directly input and set.
Upside down	Flip the hand upside and down.
Flip	Flip the hand back and forth.
Reset	Reset the hand position. Return to the state when you added the grasp point by right-clicking.

- Edit grasp

Item	Description
Pattern	Set a grasp pattern that allows the registration of multiple poses of grasping at once. <ul style="list-style-type: none"> • Single: Register the poses of grasping one by one. • Circle: Register the poses of grasping at a time in a circular swing pattern by rotating the hand in a circumferential direction.
Start angle +/-	Adjust the start angle when Pattern is not set to <i>Single</i> . The set value is displayed in the lower left of the image area.
Stop angle +/-	Adjust the stop angle when Pattern is not set to <i>Single</i> . The set value is displayed in the lower left of the image area.
Num angle +/-	Adjust the number of angle divisions when Pattern is not set to <i>Single</i> . The set value is displayed in the lower left of the image area.
Precise (0.1deg) Moderate (1.0deg) Rough (5.0deg)	Set the amount of change in the start angle and stop angle per adjustment when Pattern is not set to <i>Single</i> .
Copy current grasp	Copy and add the current grasp point.
Guide	Change the displayed guide. <ul style="list-style-type: none"> • Plane: Plane guide • None: No guide If Pattern is set to <i>Circle</i> , the plane guide is displayed regardless of the Guide setting.
Priority	Set the priority (rank) of the grasp point that is used when calculating the Grasping grade in the Grasp Planning processing item. In the calculation of the Grasping grade in the Grasp Planning processing item, the overall grasping grade, including the posture of the hand and the distance to the workpiece during grasping, is calculated. For example, even if the priority of a grasp point is set to <i>Low</i> , the grasp point may be calculated lower than (superior in grade to) another grasp point that is set to <i>High</i> . <ul style="list-style-type: none"> • High: Rank A • Low: Rank B, the Grasping grade is greater than 1 (B1).

- d) Others

Item	Description
Save	Save the created grasp pose data. If the pose of grasping is not registered, or if there is an error in the grasping pose settings, the data cannot be saved.
Exit	Close the grasp registration tool GraspTeachGUI . If the data is not yet saved, a dialog is displayed, asking whether to save the data.

- 7** When the save of the data is completed, the name of the created grasp pose data and the names of the CAD data and hand data used are displayed. You can click the **Edit** button to edit the created grasp pose data in the grasp registration tool **GraspTeachGUI** dialog.

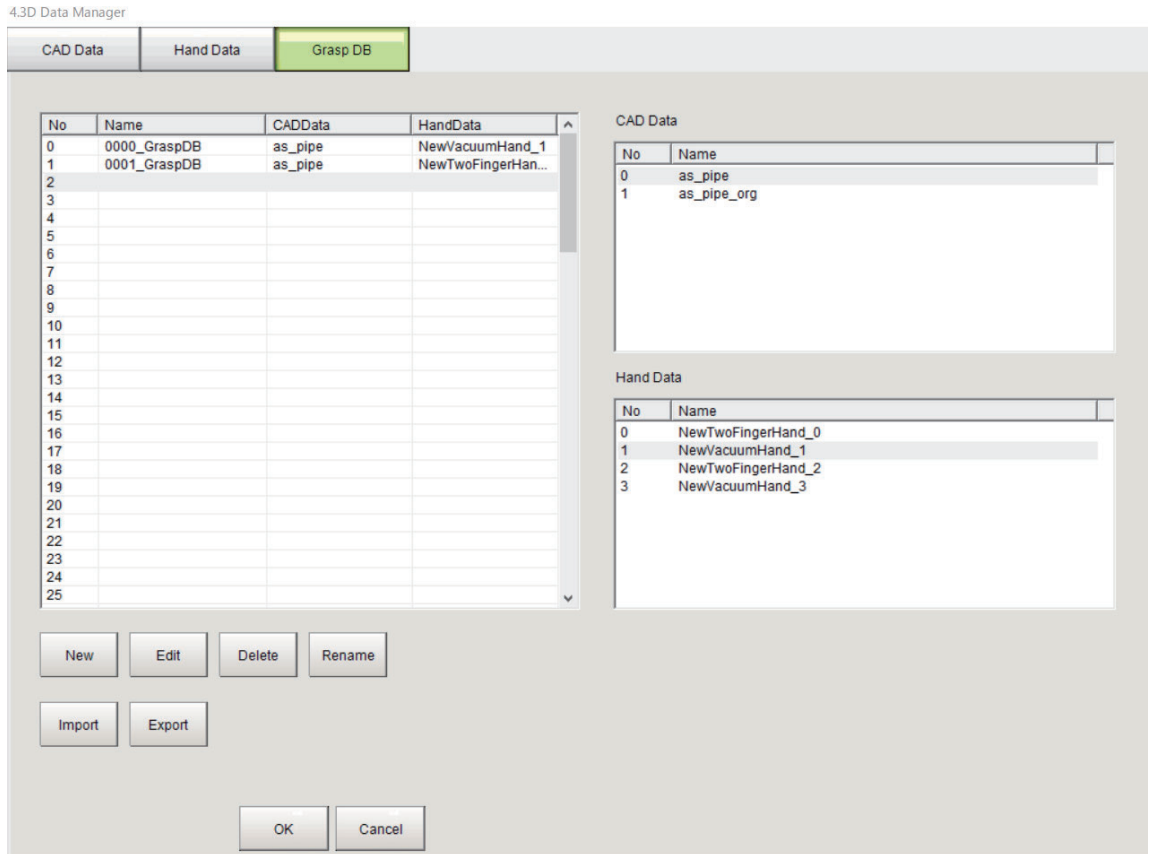

- 8 If necessary, click the **Rename** button and change the name.
- 9 You can click the **Export** button to save the created grasp pose data to a file. In addition, you can click on the **Import** button to load the saved grasp pose data file.



Precautions for Correct Use

If the file path contains 256 characters or more, the data cannot be loaded.

4-2-4 Key Points for Test Measurement and Adjustment (3D Data Manager)

The following content is displayed in the *Detail result* area as text.

Displayed item	Description
Judge	Judgment result 0: No judgment (unmeasured) 1: Judgment result OK -1: Judgment result NG -10: Error (image format mismatch) -12: Error (insufficient memory) -20: Error (other errors)

Key Points for Adjustment (3D Data Manager)

Adjust the setting parameters referring to the following points.

● When loading of CAD data, hand data, or grasp pose data in the grasp DB fails

Parameter to be adjusted	Remedy
Measurement flow	If an insufficient memory error is displayed in the message box, you may be running out of memory. Remove any memory-intensive units from the scene, or remove unused scenes from the scene group.
CAD Data Hand Data Grasp DB	If an insufficient memory error is displayed in the message box, you may be running out of memory. Delete CAD data, hand data, and grasp DB data that are not used.
CAD Data Hand Data Grasp DB	The loaded data may be corrupted. Check the data.

● When drawing of CAD data is slow

Parameter to be adjusted	Remedy
CAD Data	The amount of mesh in the CAD data may be too large. Open the STL file in CAD software and check if the mesh is not too dense. Reduce the amount of mesh, if possible.
	The amount of mesh in the CAD data may be too large. Reduce the drawing scale.
	Drawing surface CAD data may take a long time. When drawing solid CAD data, uncheck the Draw surface CAD box.
	Drawing surface CAD data may take a long time. Reduce the drawing scale.

● When hand data cannot be saved

Parameter to be adjusted	Remedy
HandMaker	If an error dialog is displayed when saving hand data in HandMaker dialog, the hand data may not have the part configuration required for the hand. For two-finger hands, configure hand data so that it includes Left and Right tip finger parts one each, and Base parts. For vacuum hands, configure hand data that includes only one Bellows part and Base parts.

● When grasp pose data cannot be saved

Parameter to be adjusted	Remedy
GraspTeachGUI	No grasp points may be set. If Grasp point in the image display area shows 0/0, register grasp points.
	A collision may occur between the hand and workpiece at a grasp point. Check the registered grasp points and adjust the grasping pose so that the hand is not displayed in yellow at all of the grasp points.
	If a two-finger hand is used, the direction of grasping may be set incorrectly. Check the Direction setting in the image display area and set the opening/closing direction appropriately.
	If a one-point vacuum hand is used, the area of the Pad or Bellows part may not reach 1% of the workpiece area. In the HandMaker dialog, create hand data with a larger hand size and register grasp points.
	If a one-point vacuum hand is used, the area of the Pad or Bellows part may not reach 1% of the workpiece area. In the HandMaker dialog, create hand data with a larger margin and register grasp points.
	Collision detection may be meaningless because the hand is away from the workpiece. For two-finger hands, check if there are registered grasp points that does not touch (cannot be grasped) the workpiece when the fingers are closed (or opened), and recreate the hand data or adjust the grasp points. For vacuum hands, check if there are registered grasp points that does not touch (cannot be grasped) the workpiece in the extension or contraction position range of Bellows parts, and recreate the hand data or adjust the grasp points.

● When collision detection is not working correctly

Parameter to be adjusted	Remedy
HandMaker GraspTeachGUI	If a collision is detected between the workpiece and hand although they do not appear to be collided, it may be due to the setting in the HandMaker dialog for inflating the hand by a margin. Set HandStyle to <i>Fat</i> and adjust the pose of grasping while checking that the collision does not occur.
	If a collision is detected between the workpiece and hand although they do not appear to be collided, it may be due to the setting in the HandMaker dialog for inflating the hand by a margin. In the HandMaker dialog, create a hand with a smaller margin and adjust the grasp point.
	If no collision is detected between the workpiece and hand although they appear to be collided, the hand may be too small for the size of the workpiece, resulting in detection of no collisions between the hand and the point clouds for collision detection sampled on the workpiece surface. In the HandMaker dialog, create a hand with a larger hand size and adjust the pose of grasping.
	If no collision is detected between the workpiece and hand although they appear to be collided, the hand may be too small for the size of the workpiece, resulting in detection of no collisions between the hand and the point clouds for collision detection sampled on the workpiece surface. In the HandMaker dialog, create a hand with a larger margin and adjust the pose of grasping.

4-2-5 Measurement Results for Which Output Is Possible (3D Data Manager)

The following values can be output using processing items related to result output. It is also possible to reference measurement values from calculation expressions and other processing units.

Measurement items	Character string	Description
Judge	JG	Judgment result 0: No judgment (unmeasured) 1: Judgment result OK -1: Judgment result NG -10: Error (image format mismatch) -12: Error (insufficient memory) -20: Error (other errors)

4-2-6 External Reference Tables (3D Data Manager)

No.	Data name	Data ident	Set/Get	Data range
0	Judge	judge	Get only	0: No judgment (unmeasured), 1: Judgment result OK, -1: Judgment result NG, -10: Error (image format mismatch), -11: Error (unregistered model), -12: Error (insufficient memory), -20: Error (other errors)

4-3 Camera Calibration AOS

This is a processing item specific to the FH series 3D robot vision system.

The processing item is intended for calibrating the camera (3D vision sensor) using a dedicated calibration plate.

Check if geometric variation has occurred in the camera and the projector inside the 3D vision sensor due to temperature changes in the external or internal environment. If geometric variation has occurred, adjust the calibration data for the 3D vision sensor according to the current geometry.

Since the geometric variation may occur due to a temperature change inside the sensor, you need to check and calibrate the camera for geometric variation after the sensor status is changed from warm-up incomplete (power OFF) to warmup complete.

To check and calibrate the camera for geometric variation, use a dedicated calibration plate (camera calibration target: FH-XCAL-S). For the input image, you need the dedicated 3D vision sensor and measurement images from the **Camera Image Input AOS** processing item. For calibration, you need measurement images at two points: one at a distance of 400 mm (near image) and the other at a distance of 600 mm (far image) from the 3D vision sensor.

Used in the Following Case

On-hand camera calibration using the camera calibration target (FH-XCAL-S)

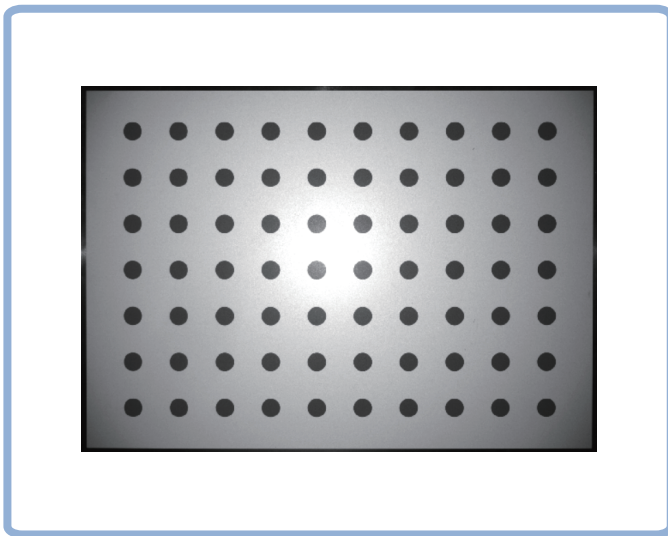

Precautions for Correct Use

- For calibration, use a dedicated calibration plate (camera calibration target: FH-XCAL-S).
- Set the calibration plate so that the postures RX, RY, and RZ are within $\pm 5^\circ$ since its detection accuracy affects the calibration.
- In the referenced **Camera Image Input AOS** processing item, click **Select camera** and then click the **Update** button to make sure that the 3D vision sensor holds the latest calibration data.
- This calibration must be performed when the status of the connected 3D vision sensor is warmup completed.

4-3-1 Settings Flow (Camera Calibration AOS)

To set Camera Calibration AOS, follow the steps below.

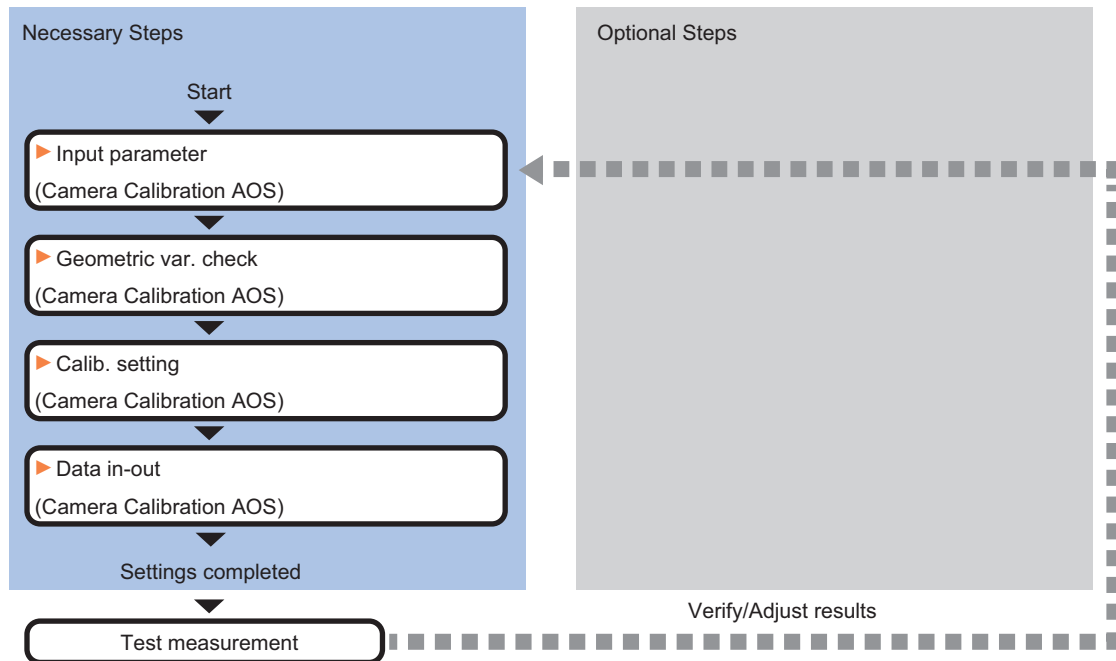

List of Camera Calibration AOS Items

Item	Description
Input parameter	Check the input parameters. <i>4-3-2 Input parameter (Camera Calibration AOS) on page 4-42</i>
Geometric var. check	Check the camera for geometric variation. <i>4-3-3 Geometric var. check (Camera Calibration AOS) on page 4-43</i>
Calib. setting	Perform calibration setting before camera calibration. <i>4-3-4 Calib. setting (Camera Calibration AOS) on page 4-46</i>
Data in-out	Reflect the calibration results on the 3D vision sensor. <i>4-3-5 Data in-out (Camera Calibration AOS) on page 4-53</i>

4-3-2 Input parameter (Camera Calibration AOS)

Check the input parameters.

- In the Item tab area, click the **Input parameter** tab.

In the **3D Imaging unit settings** area, check that the referenced **Camera Image Input AOS** processing item is set.

By this setting, the **Camera Image Input AOS** processing item located at the beginning of the same scene is referenced. If not set, review the flow and set it.

In the referenced **Camera Image Input AOS** processing item, check **3D imaging ON** in the **Camera setting (3D)** tab and **2D imaging ON** in the **Camera setting (2D)** tab.

Check that the measurement results for the Camera Image Input AOS are displayed in the image area.

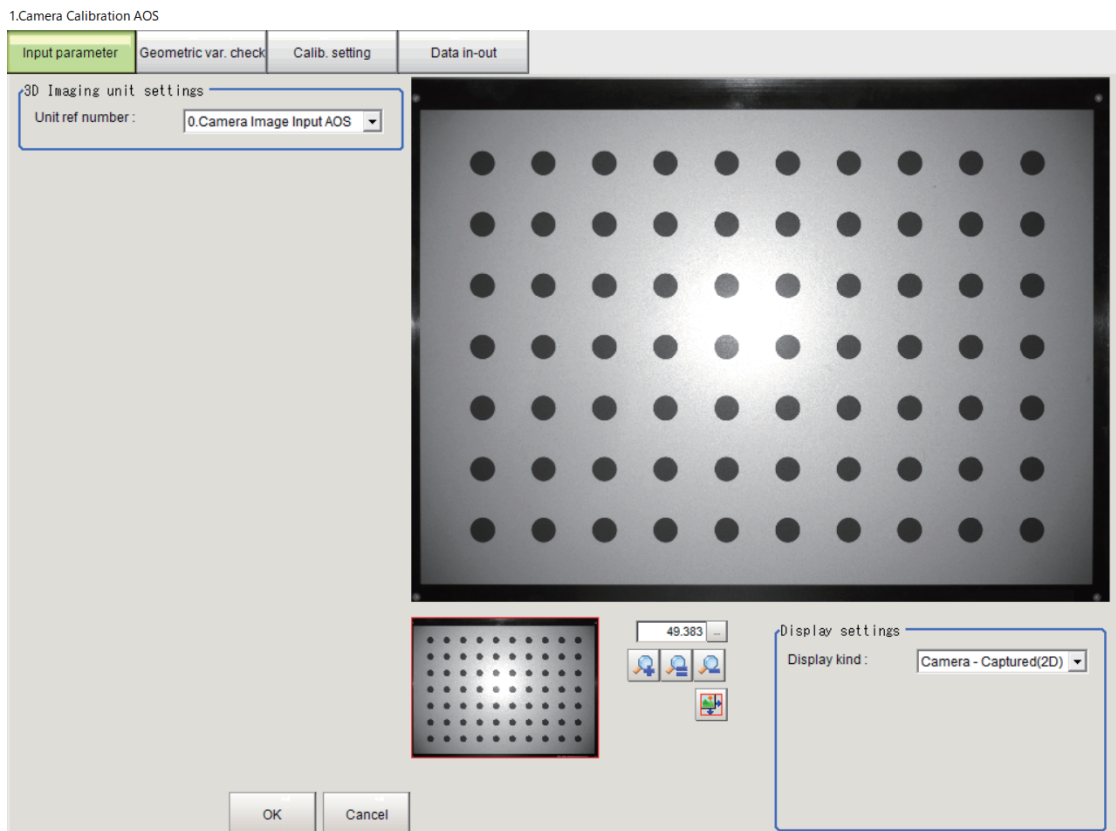

- In the **Display settings** area, you can change the image to display.

Setting item	Setting value [Factory default]	Description
Image kind	<ul style="list-style-type: none"> [Camera - Captured (2D)] Camera - Captured (3D) Camera - Depth image 	<p>Select the image to display in the Image display area.</p> <ul style="list-style-type: none"> Camera - Captured (2D): The raw image (2D) from the Camera Image Input AOS processing item is displayed. If the 2D imaging settings are not enabled, the displayed image is completely black. Camera - Captured (3D): The raw image (3D) from the Camera Image Input AOS processing item is displayed. If the 3D imaging settings are not enabled, the displayed image is completely black. Camera - Depth image: The distance image from the Camera Image Input AOS processing item is displayed.

4-3-3 Geometric var. check (Camera Calibration AOS)

Check the camera for geometric variation.

View

Switches the display in the Image display area.

- 1 In the Item tab area, click the **Geometric var. check** tab. You can also set this from the **Calib. setting** tab.

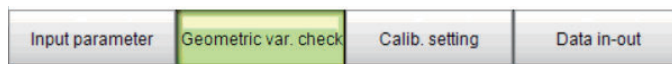

- 2 Click **Change display** to select the type of camera image. The display in the Image display area will switch.

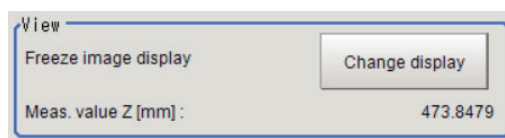

Setting item	Setting value [Factory default]	Description
Display	<ul style="list-style-type: none"> Through image [Freeze image] 	<ul style="list-style-type: none"> Through image: The latest image is always loaded from the camera and displayed. Freeze image: The image loaded in the immediately preceding measurement is displayed.
Meas. value Z [mm]	-	When a through image is displayed, the Average value of Z at the Detection point set in the Camera setting (3D) tab in the Camera Image Input AOS processing item is displayed. The black crosshair is displayed at the Detection point on the image display area.

Checking the Geometric Variation

- 1 In the Item tab area, click the **Geometric var. check** tab.

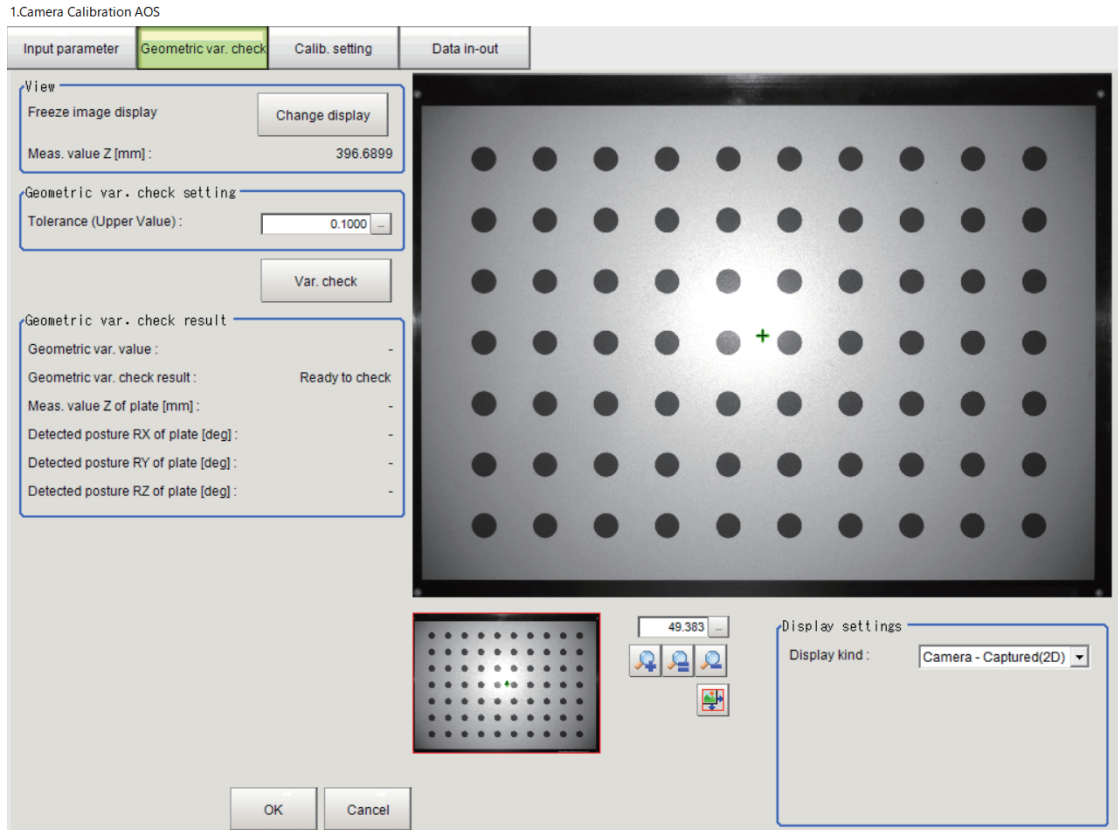

- 2 Set the value in the **Geometric var. check setting**.

Setting item	Setting value [Factory default]	Description
Tolerance (Upper Value)	-0.0000 to 100.0000 [0.1000]	Set the threshold for checking if geometric variation has occurred.

- 3 Click **Var. check**. Check the geometric variation.
The **Geometric var. check result** area is updated.
When a through image is displayed, you cannot click the **Var. check** button.

Displayed item	Description
Geometric var. value	The geometric variation value is displayed.

Displayed item	Description
Geometric var. check result	<p>If the geometric variation value is equal to or less than Tolerance (Upper Value), <i>No need calib.</i> is displayed.</p> <p>If the geometric variation value is greater than Tolerance (Upper Value), <i>Need calib.</i> is displayed.</p> <p>If the geometric variation check has not been executed, <i>Ready to check</i> is displayed.</p> <p>If the geometric variation check has failed, <i>Failed</i> is displayed. This result is displayed in red text.</p> <p>If Meas. value Z of plate is not within the range of 350 to 650 mm, <i>Check failed (Wrong plate distance)</i> is displayed. This result is displayed in red text.</p> <p>If Detected posture RX of plate, Detected posture RY of plate, or Detected posture RZ of plate is out of the $\pm 5^\circ$ range, <i>Check failed (Wrong plate posture)</i> is displayed. This result is displayed in red text.</p>
Meas. value Z of plate [mm]	<p>The measurement distance from the 3D vision sensor to the black dot at the upper left of the calibration plate is displayed.</p> <p>It is not displayed when the geometric variation check result is Failed or Ready to check.</p>
Detected posture RX of plate [deg]	The posture of the calibration plate seen from the 3D vision sensor is displayed in XYZ Euler angle.
Detected posture RY of plate [deg]	It is not displayed when the geometric variation check result is Failed or Ready to check.
Detected posture RZ of plate [deg]	

Checking the Geometric Variation on the Image (Display Settings)

You can change the display settings to check the processing conditions for measurements on the image.

- 1 Set the value in the **Display settings** area.

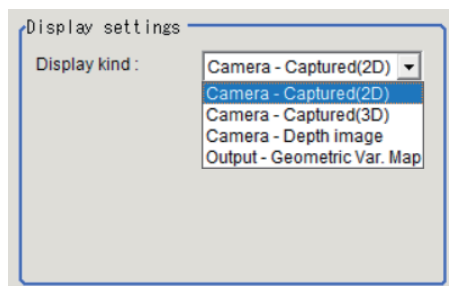

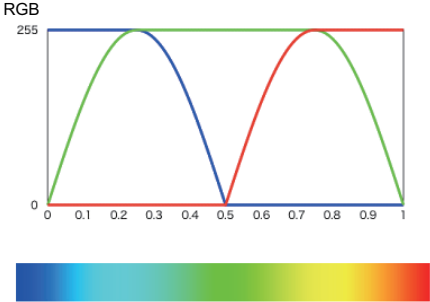
Setting item	Setting value [Factory default]	Description
Image kind	<ul style="list-style-type: none"> [Camera - Captured (2D)] Camera - Captured (3D) Camera - Depth image Output - Geometric Var. Map 	<p>Select the image to display in the Image display area.</p> <ul style="list-style-type: none"> Camera - Captured (2D): The raw image (2D) from the Camera Image Input AOS processing item is displayed. If the 2D imaging settings are not enabled, the displayed image is completely black. Camera - Captured (3D): The raw image (3D) from the Camera Image Input AOS processing item is displayed. If the 3D imaging settings are not enabled, the displayed image is completely black. Camera - Depth image: The distance image from the Camera Image Input AOS processing item is displayed. Output - Geometric Var. Map: An image that visualizes the values of geometric variation on the calibration plate is displayed. Geometric variation map refers to processing that normalizes values between 0 and Tolerance (Upper Value) to 0 to 1.0 and visualize them in blue to red according to the color table in the following figure. Pixels with values that exceed the Tolerance (Upper Value) are saturated in red. On the other hand, pixels with incalculable geometric variation values will be processed in black. <p>RGB</p> 

2 Check the geometric variation on the image.

4-3-4 Calib. setting (Camera Calibration AOS)

Perform calibration setting before camera calibration.



Precautions for Correct Use

If you have changed scenes after the previous calibration, perform calibration setting after executing **Clear measurement** from the **Function** menu.

View

Switches the display in the Image display area.

1 In the Item tab area, click the **Calib. setting** tab.
You can also set this from the **Geometric var. check** tab.



- 2** Click **Change display** to select the type of camera image. The display in the Image display area will switch.

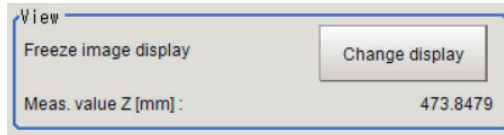

Setting item	Setting value [Factory default]	Description
Display	<ul style="list-style-type: none"> Through image [Freeze image] 	<ul style="list-style-type: none"> Through image: The latest image is always loaded from the camera and displayed. Freeze image: The image loaded in the immediately preceding measurement is displayed.
Meas. value Z [mm]	-	When a through image is displayed, the Average value of Z at the Detection point set in the Camera setting (3D) tab in the Camera Image Input AOS processing item is displayed. The black crosshair is displayed at the Detection point on the image display area.

Calibration

● Registering calibration images

Register calibration images.

For calibration, you need measurement images at two points: one at a distance of 400 mm (near image) and the other at a distance of 600 mm (far image) from the 3D vision sensor.

- 1** In the Item tab area, click the **Calib. setting** tab.

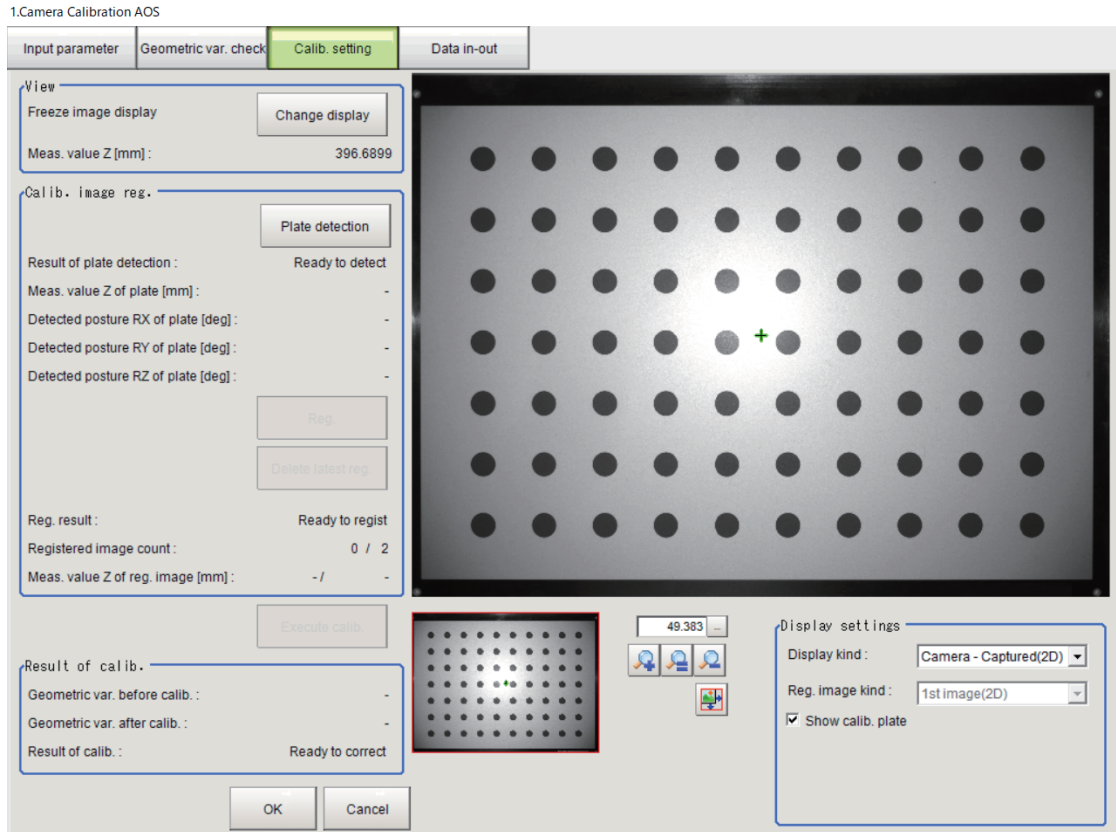

Register the first image. Perform this registration with the image displayed at a distance of 400 mm from the 3D vision sensor (near image).

- 2** In the **Calib. image reg.** area, click the **Plate detection** button.
If a through image is displayed, you cannot click the **Plate detection** button.

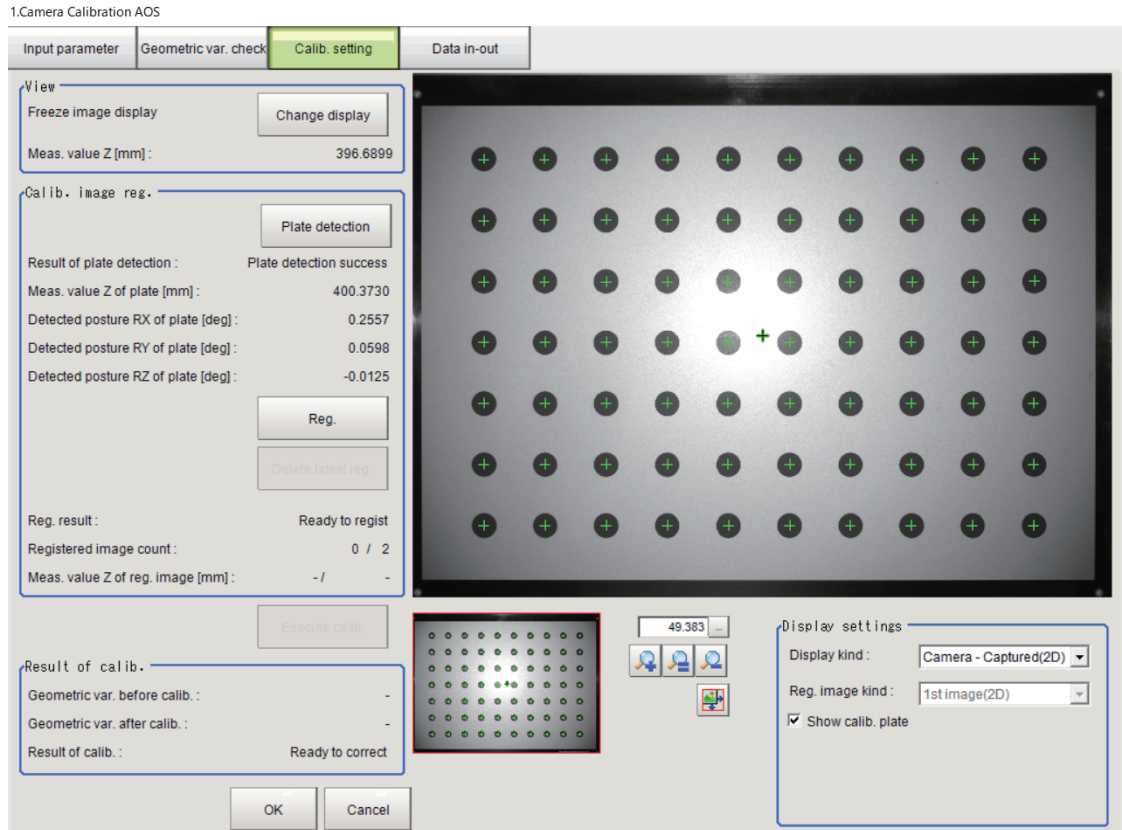

The displayed plate detection results are updated.

If the calibration plate is detected, a green crosshair is shown at the center of each black dot on the calibration plate.

Displayed item	Description
Result of plate detection	If the calibration plate has been detected successfully, <i>Plate detection success</i> is displayed. If the postures RX, RY, and RZ of the detected calibration plate are not within the range of $\pm 5^\circ$, <i>Wrong plate posture</i> is displayed in red text. If the measurement value Z of the detected calibration plate is not within the range of 350 to 650 mm, <i>Wrong plate distance</i> is displayed in red text. If the detection of the calibration plate has failed, <i>Plate detection failed</i> is displayed in red text. If the detection of the calibration plate has not been executed, <i>Ready to detect</i> is displayed.
Meas. value Z of plate [mm]	The measurement distance from the 3D vision sensor to the black dot at the upper left of the calibration plate is displayed. This is not displayed when the result of calibration plate detection is Failed or Ready to detect.
Detected posture RX of plate [deg]	The posture of the calibration plate seen from the 3D vision sensor is displayed in XYZ Euler angle.
Detected posture RY of plate [deg]	This is not displayed when the result of calibration plate detection is Failed or Ready to detect.
Detected posture RZ of plate [deg]	

- 3 If the calibration plate is successfully detected, the **Reg.** button is enabled. Click the **Reg.** button.

This registers the image as an image for calibration use and updates the displayed registration result. It may take some time for registration.

Clicking the **Delete latest reg.** button deletes the registered calibration image. If the calibration is completed, this also deletes the calibration results.

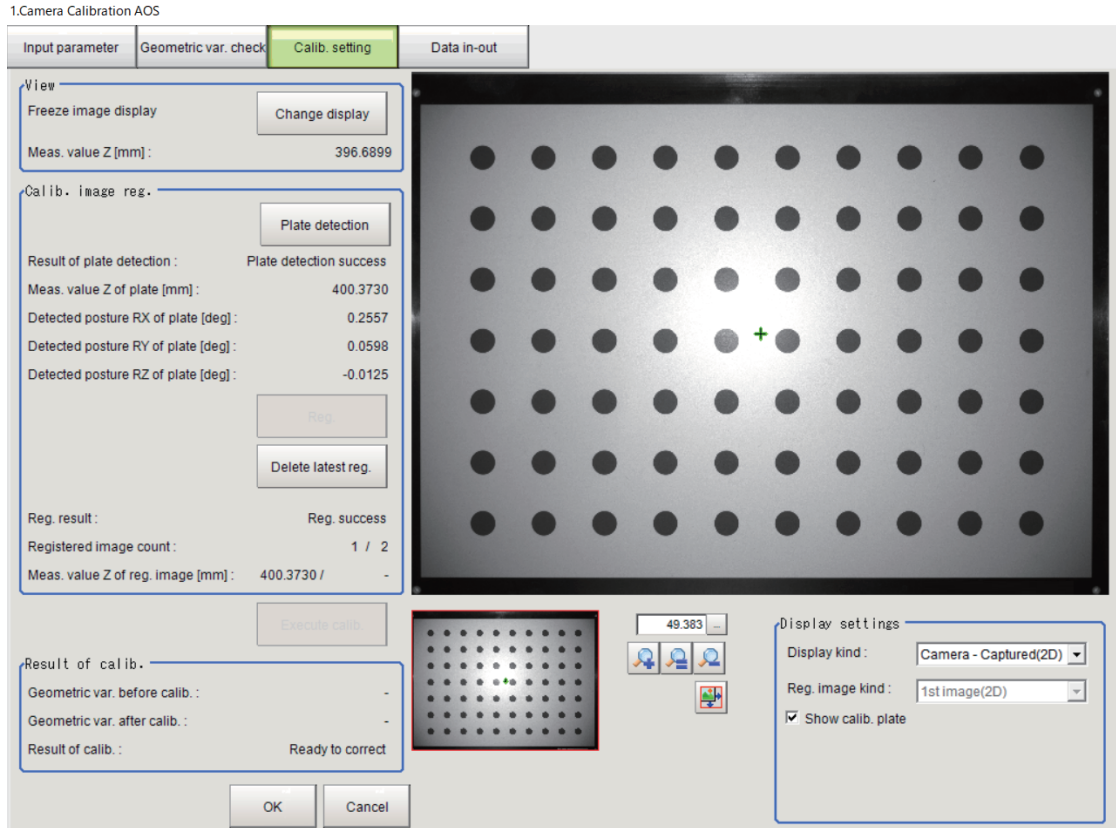

Displayed item	Description
Reg. result	If the registration of the calibration image is successful, <i>Reg. success</i> is displayed. If the registration of the calibration image has failed, the registration error is displayed in red text. If the difference in the measurement distance between the two images is less than 190 mm, <i>Reg. failed (wrong distance)</i> is displayed.
Registered image count	The number of the registered calibration images is displayed.
Meas. value Z of reg. image [mm]	The measurement distances of the registered images are displayed. Measurement distance of the first image/Measurement distance of the second image

- 4 Register the second image. (Same as steps 2 to 3)
Perform this registration with the image displayed at a distance of 600 mm from the 3D vision sensor (far image).

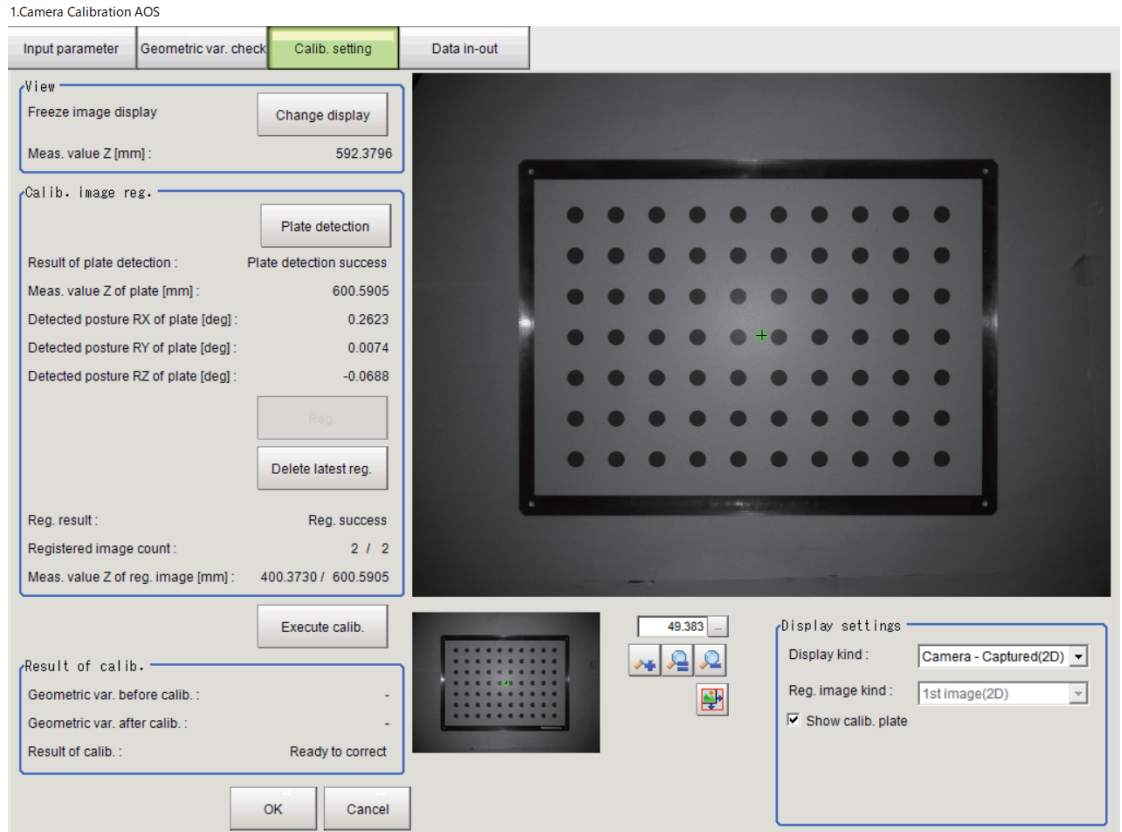

● Executing calibration

Execute calibration using the two images that you registered.

- 1 With *Reg. success* displayed in **Reg. result** in the **Calib. image reg.** area, click the **Execute calib.** button.
The calibration results are displayed in the **Result of calib.** area. It may take some time to execute calibration.

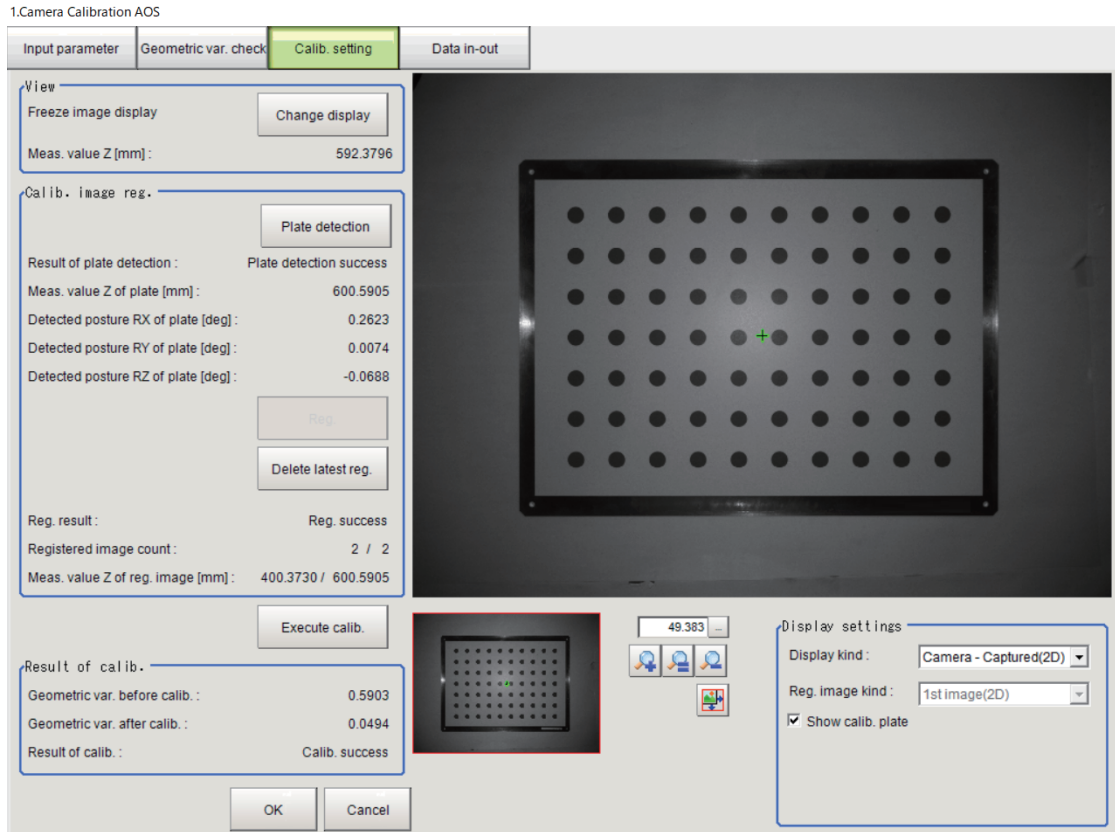

Displayed item	Description
Geometric var. before calib.	The value of geometric variation before calibration calculated from the registered two images is displayed.
Geometric var. after calib.	The value of geometric variation after calibration calculated from the registered two images is displayed.
Result of calib.	If the calibration is successful, <i>Calib. success</i> is displayed. If the value of geometric variation before calibration is greater than 1.0, <i>Unable to correct</i> is displayed. This result is displayed in red text. If the value of geometric variation after calibration is greater than 0.1, <i>Calib. bad result</i> is displayed. This result is displayed in red text. If the calibration has failed, <i>Calib. failed</i> , <i>Wrong plate dist.</i> , <i>Wrong plate pos.</i> , or <i>Wrong dist. between images</i> is displayed. This result is displayed in red text. If the calibration has not been executed, <i>Ready to correct</i> is displayed.

Checking the Calibration Setting on the Image (Display Settings)

You can change the display settings to check the processing conditions for measurements on the image.

- 1 Set the value in the **Display settings** area.

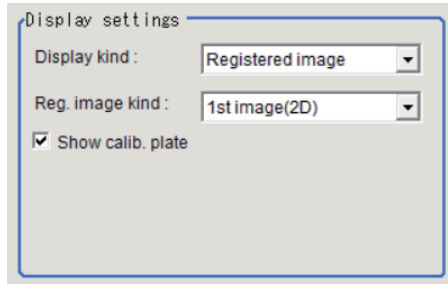

Setting item	Setting value [Factory default]	Description
Display kind	<ul style="list-style-type: none"> [Camera - Captured (2D)] Camera - Captured (3D) Camera - Depth image Registered image 	<p>Select the image to display in the Image display area.</p> <ul style="list-style-type: none"> Camera - Captured (2D): The raw image (2D) from the Camera Image Input AOS processing item is displayed. If the 2D imaging settings are not enabled, the displayed image is completely black. Camera - Captured (3D): The raw image (3D) from the Camera Image Input AOS processing item is displayed. If the 3D imaging settings are not enabled, the displayed image is completely black. Camera - Depth image: The distance image from the Camera Image Input AOS processing item is displayed. Registered image: The calibration image selected in Reg. image kind is displayed.
Reg. image kind	<ul style="list-style-type: none"> 1st image (2D) 1st image (3D) 2nd image (2D) 2nd image (3D) 	<p>Set this item only when Display kind is <i>Registered image</i>. Select the type of registered image to display.</p> <ul style="list-style-type: none"> 1st image (2D): The raw image (2D) of the first registered image will be displayed. 1st image (3D): The raw image (3D) of the first registered image will be displayed. 2nd image (2D): The raw image (2D) of the second registered image will be displayed. 2nd image (3D): The raw image (3D) of the second registered image will be displayed.
Show calib. plate	<ul style="list-style-type: none"> [Checked] Unchecked 	<p>Check this to display on the calibration plate image a green crosshair in each black dot that indicates the detection position.</p> <p>The crosshair on the image will be displayed in red if the calibration plate is out of the detection range due to its posture.</p>

2 Check the calibration setting on the image.

4-3-5 Data in-out (Camera Calibration AOS)

Reflecting calibration results on the 3D vision sensor (Data in-out)

Reflect the calibration results on the 3D vision sensor.

1 In the Item tab area, click the **Data in-out** tab.

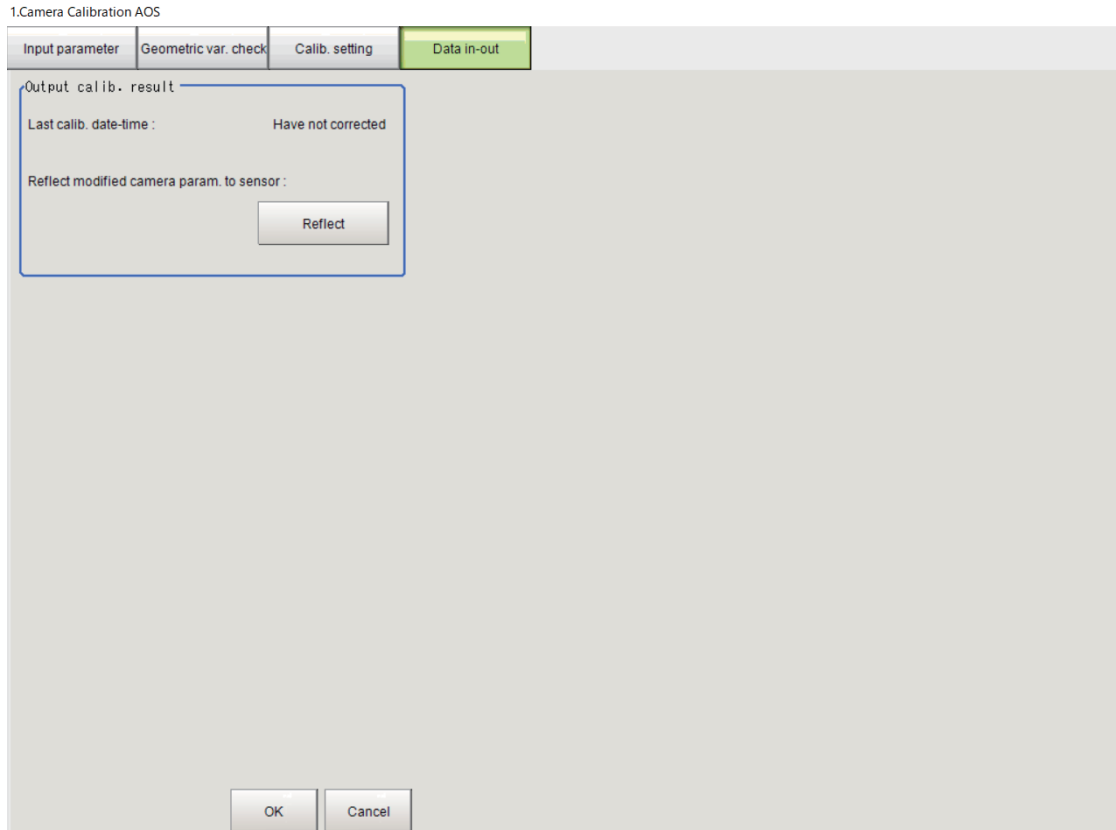

Displayed item	Description
Last calib. date-time	The date and time when the 3D vision sensor was calibrated is displayed. If calibration has been performed, the date is displayed as 2021/2/3 11:26:37, for example.
Reflect modified camera param. to sensor	The Reflect button is available when the Result of calib. in the Calib. setting is <i>Calib. success</i> . Click the Reflect button to write the calibration results to the 3D vision sensor.

- Click the **Reflect** button.
A warning dialog is displayed.

Precaution

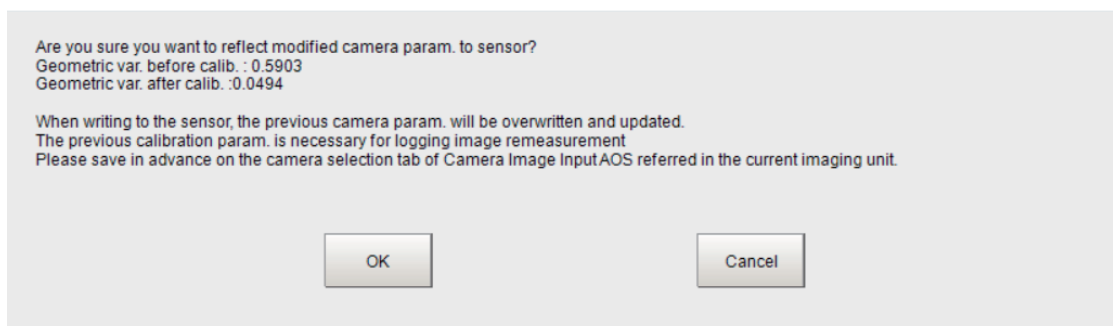

- Click **OK** to write the calibration results to the 3D vision sensor.

4-3-6 Key Points for Test Measurement and Adjustment (Camera Calibration AOS)

The following content is displayed in the *Detail result* area as text.

Displayed item	Description
Judge	Judgment result 0: No judgment (unmeasured) 1: Judgment result OK -1: Judgment result NG -10: Error (image format mismatch) -12: Error (insufficient memory) -20: Error (other errors)
Reg. image count	This item is displayed only when Measure mode is set to 1 (Auto mode). (For the auto mode, refer to <i>Performing Camera Calibration during Measurement Processing (Auto Mode)</i> on page 4-56.) Reg. image count/2 When image registration is completed, 2/2 (<i>completed</i>) is displayed.
Geometric var. check result	This item is displayed only when Measure mode is set to 1 (Auto mode). This item is displayed only when image registration is completed. If the geometric variation value is equal to or less than Tolerance (Upper Value) , <i>No need calib.</i> is displayed. If the geometric variation value is greater than Tolerance (Upper Value) , <i>Need calib.</i> is displayed. If the geometric variation check has failed, <i>Failed</i> is displayed. If Meas. value Z of plate is not within the range of 350 to 650 mm, <i>Check failed (Wrong plate distance)</i> is displayed. If Detected posture RX of plate , Detected posture RY of plate , or Detected posture RZ of plate is out of the $\pm 5^\circ$ range, <i>Check failed (Wrong plate posture)</i> is displayed.
Geometric var. value	This item is displayed only when Measure mode is set to 1 (Auto mode). This item is displayed only when image registration is completed. The geometric variation value is displayed.
Result of calib.	This item is displayed only when Measure mode is set to 1 (Auto mode). This item is displayed only when image registration is completed. It is displayed only when calibration is required. If the calibration is successful, <i>Calib. success</i> is displayed. If the value of geometric variation before calibration is greater than 1.0, <i>Unable to correct</i> is displayed. If the value of geometric variation after calibration is greater than 0.1, <i>Calib. bad result</i> is displayed. If the calibration has failed, <i>Calib. failed</i> , <i>Wrong plate dist.</i> , <i>Wrong plate pos.</i> , or <i>Wrong dist. between images</i> is displayed.
Geometric var. before calib.	This item is displayed only when Measure mode is set to 1 (Auto mode). This item is displayed only when image registration is completed. It is displayed only when calibration has been executed. The value of geometric variation before calibration calculated from the registered two images is displayed.
Geometric var. after calib.	This item is displayed only when Measure mode is set to 1 (Auto mode). This item is displayed only when image registration is completed. It is displayed only when calibration has been executed. The value of geometric variation after calibration calculated from the registered two images is displayed.
Result of output calib.	This item is displayed only when Measure mode is set to 1 (Auto mode). It is displayed only when calibration is successful. When the writing is successful, Success is displayed. When the writing has failed, Failed is displayed.

The image specified in the Sub-image number in the image display setting is displayed in the *Image Display* area.

Sub-image number	Description of image to be displayed
0	Measurement image with detection results of calib. plate overlaid
1	Measurement image

Performing Camera Calibration during Measurement Processing (Auto Mode)

Camera calibration is not performed during measurement because it is normally performed on the setting screen for the processing item as described earlier. However, by setting the auto mode, you can perform camera calibration during measurement.

- 1 Set the **Measure mode** (Data ident: autoMeasMode, No.: 510) for the external reference data to 1 to set the auto mode.

Alternatively, you can select **TDM Editor** from the **Tool** menu, click **Set - Open the unit setting UI**, and set **Measure mode** to 1 under **Measurement parameter** in the **Input parameters** tab.

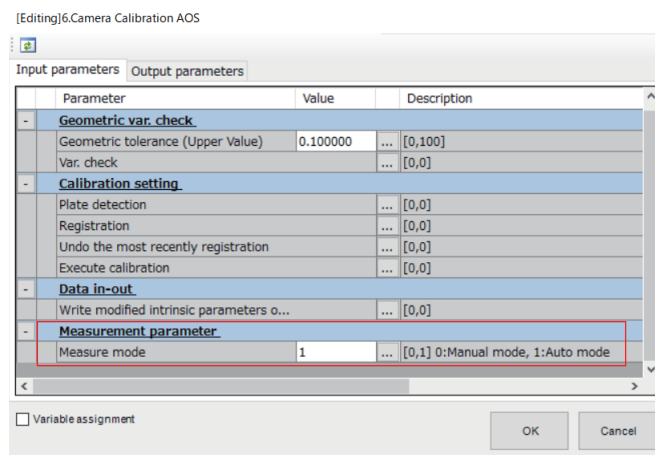

- 2 Execute **Clear measurement** from the **Function** menu to clear the images registered in this processing item.
- 3 Execute the first measurement processing.
This registers the first image (near image). The processing ends at this point.
- 4 Execute the second measurement processing.
This registers the second image (far image). A geometric variation check is executed. If "Geometric var. check result" is "Need calib.", calibration is executed. If the calibration is successful, the calibration results are written to the 3D vision sensor, **Measure mode** is reset to 0, and then the processing ends.
If "Geometric var. check result" is "No need calib.", the processing ends at this point.
If "Geometric var. check result" is "Failed", or the calibration is failed, **Measure mode** is reset to 0 and the processing ends.

Key Points for Adjustment (Camera Calibration AOS)

Adjust the setting parameters referring to the following points.

● When the measurement image is not displayed

Parameter to be adjusted	Remedy
Input parameter	The Camera Image Input AOS processing item may not be referenced with the Input parameter settings. Review the Unit ref number setting in the Input parameter tab.
Camera Image Input AOS processing item	In the referenced Camera Image Input AOS processing item, 3D imaging ON and 2D imaging ON may not be checked. Review the settings of the Camera Image Input AOS processing item.

● When the geometric variation check fails

Parameter to be adjusted	Remedy
-	The calibration plate may not be installed in the field of view. Check the measurement image and adjust the installation position of the calibration plate so that the whole black dot pattern is in the field of view.
Camera Image Input AOS processing item	The black dot pattern on the calibration plate may not be captured clearly due to halation. In the referenced Camera Image Input AOS processing item, review the Camera setting (2D) settings.
-	If Geometric var. check result in the Geometric var. check tab shows <i>Check failed (Wrong plate distance)</i> , adjust the distance from the 3D vision sensor to the calibration plate to within the measurement range.
-	If Geometric var. check result in the Geometric var. check tab shows <i>Check failed (Wrong plate posture)</i> , adjust the Detected posture RX of plate , Detected posture RY of plate , and Detected posture RZ of plate settings to within the $\pm 5^\circ$ range.

● When the plate detection fails in calibration settings

Parameter to be adjusted	Remedy
-	The calibration plate may not be installed in the field of view. Check the measurement image and adjust the installation position of the calibration plate so that the whole black dot pattern is in the field of view.
Camera Image Input AOS processing item	The black dot pattern on the calibration plate may not be captured clearly due to halation. In the referenced Camera Image Input AOS processing item, review the Camera setting (2D) settings.
-	If Result of plate detection in the Calib. setting tab shows <i>Wrong plate distance</i> , adjust the distance from the 3D vision sensor to the calibration plate to 400 mm for the near image and 600 mm for the far image.
-	If Result of plate detection in the Calib. setting tab shows <i>Wrong plate posture</i> , adjust the Detected posture RX of plate , Detected posture RY of plate , and Detected posture RZ of plate settings to within the $\pm 5^\circ$ range.

● **When the registration of calibration images fails in calibration settings**

Parameter to be adjusted	Remedy
-	The measurement distance between the two images may be too close. Register the near and far images so that their distances are 400 mm and 600 mm, respectively.

● **When the calibration fails**

Parameter to be adjusted	Remedy
Camera Image Input AOS processing item	The feature values may be too small to calibrate the camera. In the Camera Image Input AOS processing item, review the Camera setting (3D) settings to prevent the loss of many 3D point clouds.
-	The geometric variation may be too large to calibrate the camera. If the Geometric var. before calib. value is greater than 1.0, you cannot perform calibration with this processing item. In this case, request for a repair.

● **When the result of calibration is not displayed**

Parameter to be adjusted	Remedy
-	If you have changed scenes after the previous calibration, the processing item may have lost the data to display. Perform the calibration again after executing Clear measurement from the Function menu.

4-3-7 Measurement Results for Which Output Is Possible (Camera Calibration AOS)

The following values can be output using processing items related to result output. It is also possible to reference measurement values from calculation expressions and other processing units.

Measurement items	Character string	Description
Judge	JG	Judgment result 0: No judgment (unmeasured) 1: Judgment result OK -1: Judgment result NG -10: Error (image format mismatch) -12: Error (insufficient memory) -20: Error (other errors)

4-3-8 External Reference Tables (Camera Calibration AOS)

No.	Data name	Data ident	Set/Get	Data range
0	Judge	judge	Get only	0: No judgment (unmeasured), 1: Judgment result OK, -1: Judgment result NG, -10: Error (image format mismatch), -11: Error (unregistered model), -12: Error (insufficient memory), -20: Error (other errors)
100	Ref unit number of 3D Imaging unit	camera3dUnitNo	Set/Get	-1 to 9,999
101	Check result of input image	imgCheckRet	Get only	0: OFF, 1: ON
102	Measurement Z value of 3D input unit	measZ	Get only	0 to 10,000.0000 [mm]
103	Geometric tolerance (Upper value)	geoChkTolerance	Set/Get	0 to 100.0000
104	Geometric variation	geoChkValue	Get only	0 to 100.0000
105	Diagnosis of geometric variation	geoChkRet	Get only	-1: Measure error, 0: Ready to measure, 1: Do not need correction, 2: Need correction, 3: Unable to correct, 4: Wrong plate distance, 5: Wrong plate posture
106	Result of plate detection	plateDetectRet	Get only	-1: Registration error, 0: Ready to regist, 1: Registration success, 2: Registration failed (plate detection fail), 3: Wrong plate distance, 4: Wrong plate posture
107	Measurement Z value of calibration plate	plateDist	Get only	0 to 10,000.0000 [mm]
108	Measurement RX of calibration plate	plateRX	Get only	-180.0000 to 180.0000 [deg]
109	Measurement RY of calibration plate	plateRY	Get only	-180.0000 to 180.0000 [deg]
110	Measurement RZ of calibration plate	plateRZ	Get only	-180.0000 to 180.0000 [deg]
111	Result of registration	regRet	Get only	-1: Registration error, 0: Ready to regist, 1: Registration success, 2: Registration failed (plate detection fail), 3: Registration failed (enough imaging distance)
112	Registered image count	imgRegCount	Get only	0 to 2
113	Geometric variation before correction	preGeoVar	Get only	0 to 100.0000
114	Geometric variation after correction	modGeoVar	Get only	0 to 100.0000

No.	Data name	Data ident	Set/Get	Data range
115	Result of execute calibration	calibRet	Get only	-1: Corr. error, 0: Ready to corr., 1: Corr. succeed, 2: Corr. failed, 3: Cannot corr., 4: Wrong plate distance, 5: Wrong plate posture, 6: Image is out of registration range, 7: Geometric value after calibration is out of the allowable range
116	Date and time of last calibration: Year	calibTimeYear	Get only	0 to 9,999
117	Date and time of last calibration: Month	calibTimeMonth	Get only	0 to 12
118	Date and time of last calibration: Day	calibTimeDay	Get only	0 to 31
119	Date and time of last calibration: Hour	calibTimeHour	Get only	0 to 23
120	Date and time of last calibration: Minute	calibTimeMinute	Get only	0 to 59
121	Date and time of last calibration: Second	calibTimeSecond	Get only	0 to 59
510	Measure mode	autoMeasMode	Set/Get	0: Manual mode, 1: Auto mode

4-4 HandEye Calibration

This is a processing item specific to the FH series 3D robot vision system.

This processing item calibrates the robot hand and camera (eye) to maintain the relationship of installation.

For HandEye Calibration, use a dedicated calibration target (handeye calibration target: FH-XCAL-R). It also generates the robot's sampling points required for calibration and holds the post-calibration data referenced for use by other scenes.

Used in the Following Case

On-hand camera calibration

Example: Bulk picking of parts in a container

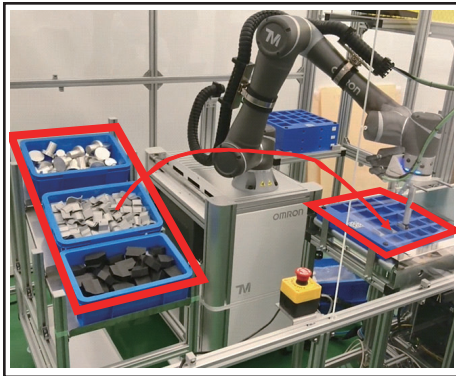

In HandEye Calibration, the position and posture of the workpiece detected in the **3D Search** processing item are converted into robot coordinates to enable the robot hand to pick up the workpiece.



Precautions for Correct Use

- This processing item references the **Robot Data** processing item. If you change the **Robot Data**, the settings of this process item will change. Be sure to review the settings.

4-4-1 Settings Flow (HandEye Calibration)

To set HandEye Calibration, follow the steps below.

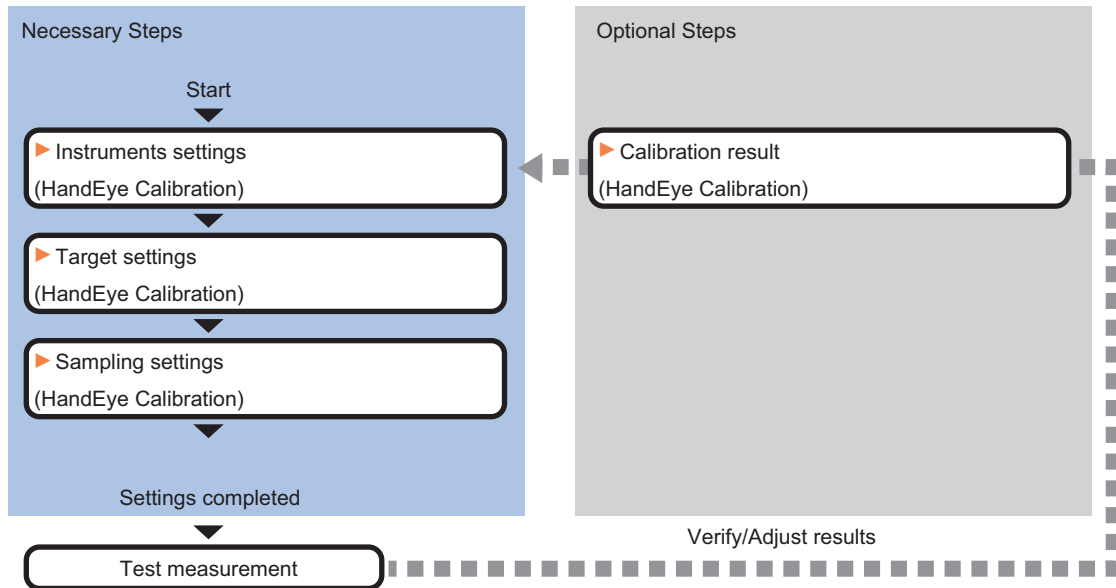

List of HandEye Calibration Items

Item	Description
Instruments settings	Select a <i>Robot Data</i> processing item holding the external device information. <i>4-4-2 Instruments settings (HandEye Calibration)</i> on page 4-63
Target settings	Make the detection settings for the calibration target. <i>4-4-3 Target settings (HandEye Calibration)</i> on page 4-65
Sampling settings	Set the data related to sampling. <i>4-4-4 Sampling settings (HandEye Calibration)</i> on page 4-67
Calibration result	Check the calibration results. If it is necessary to finely adjust the calibration results, you can directly use the editing function. It is also possible to confirm the sampling data used for the calibration. <i>4-4-5 Calibration result (HandEye Calibration)</i> on page 4-71

4-4-2 Instruments settings (HandEye Calibration)

Select a *Robot Data* processing item holding the external device information.

- 1 In the Item tab area, click the **Instruments settings** tab.

5.HandEye Calibration

Instruments settings Target settings Sampling settings Calibration result

Robot data settings

Scene ref number :

Unit ref number :

Robot type : 6-axis(XYZWPR) robot

Robot posture : ZYX Euler angle

Camera mount : On hand camera

Robot mount :

Camera mount settings (Flange coordinate)

Position X [mm] :

Position Y [mm] :

Position Z [mm] :

Camera Y-axis minus :

Posture RX [deg] :

Posture RY [deg] :

Posture RZ [deg] :

Posture type :

- 2 In the **Robot data settings** area, select a *Robot Data* processing item holding the external device information.
The information of the selected processing unit is displayed in the **Robot data settings** area.
Displayed contents vary depending on the selected type of robot.

Robot data settings

Scene ref number :

Unit ref number :

Robot type : 6-axis(XYZWPR) robot

Robot posture : ZYX Euler angle

Camera mount : On hand camera

Robot mount :

Camera mount settings (Flange coordinate)

Position X [mm] :

Position Y [mm] :

Position Z [mm] :

Camera Y-axis minus :

Setting item	Setting value [Factory default]	Description
Scene ref number	-1 to 127 [-1: current scene]	Selects the scene number including a Robot Data processing item holding the external device information.
Unit ref number	-	From among the referenced scene numbers, selects a Robot Data processing item.
Robot type	-	Displays the settings of Robot Data processing item.
Robot posture	-	
Camera mount	-	
Robot mount	[Floor mount]	Set the mount position of the robot.



Precautions for Correct Use

- If the **Robot Data** processing item is referenced when **Camera mount** is set to *Fixed*, the *Selected camera mount is not supported now* message will be displayed. Review the settings.
- If the **Robot Data** processing item is referenced when an unsupported **Robot type** is set, the *Selected robot type is not supported now* message will be displayed. Review the settings.
- If the **Scene ref number** or **Unit ref number** is changed, some of the setting parameters of this processing item and the calibration result value will be initialized. If you accidentally change the **Scene ref number** or **Unit ref number**, click the **cancel** button without clicking the **OK** button.

3 If **Camera mount** is set to *On hand camera*, set the items in the **Camera mount settings (Flange coordinate)** area.

For details, refer to *Vision System FH series 3D Robot Vision Application Construction Guide (Cat.No. Z446)*.

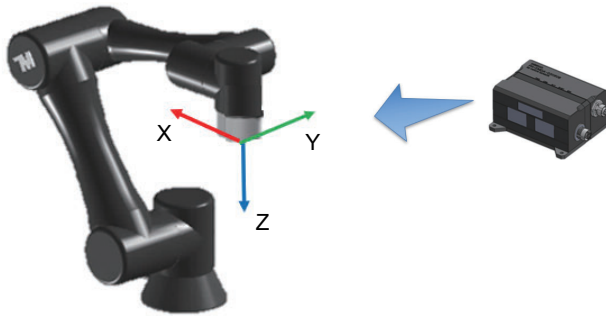

Setting item	Setting value [Factory default]	Description
Position X [mm]	-10,000.0000 to 10,000.0000[0.0000]	Set the approximate values of the camera mount position in the flange coordinate system. The values that you set here are used to determine the position where data for HandEye Calibration is captured.
Position Y [mm]	-10,000.0000 to 10,000.0000[0.0000]	
Position Z [mm]	-10,000.0000 to 10,000.0000[0.0000]	

Setting item	Setting value [Factory default]	Description
Camera Y-axis minus	<ul style="list-style-type: none"> • [X-axis plus direction] • X-axis minus direction • Y-axis plus direction • Y-axis minus direction • Custom 	<p>Set the mounting posture of the camera in the flange coordinate system.</p> <p>Specifically, set which direction the Y-axis negative direction of the camera points to in the flange coordinate system.</p>
Posture RX [deg] / Posture RZ [deg]	-180.0000 to 180.0000[0.0000]	This setting item is enabled only when Camera Y-axis minus is set to <i>Custom</i> .
Posture RY [deg]	-180.0000 to 180.0000[0.0000]	Set the mounting posture of the camera in the flange coordinate system.
Posture RZ [deg]	-180.0000 to 180.0000[0.0000]	If you set Posture type to <i>ZYZ Euler angle</i> , RX is replaced with RZ .
Posture type	<ul style="list-style-type: none"> • [ZYX Euler angle] • ZYZ Euler angle • XYZ Euler angle 	<p>This setting item is enabled only when Camera Y-axis minus is set to <i>Custom</i>.</p> <p>Set the posture angle type for the mounting posture of the camera.</p>

4-4-3 Target settings (HandEye Calibration)

Make the detection settings for the calibration target.

The setting items differ depending on the settings of the **Robot Data** processing item.

● For on-hand cameras

The following is the setting procedure for the **Robot Data** processing item when **Camera mount** is set to *On hand camera*.

- 1 In the Item tab area, click the **Target settings** tab.

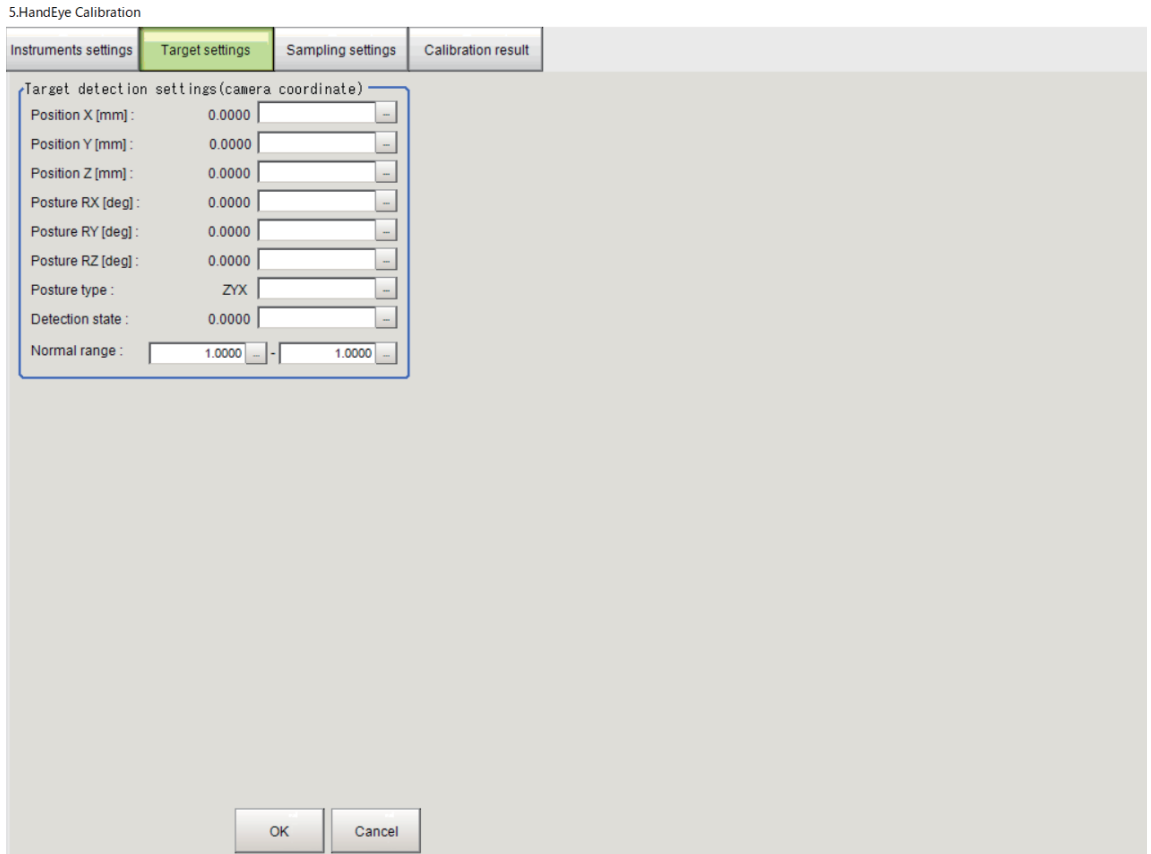

2 In the **Target detection settings (camera coordinate)** area, make the detection settings for the calibration target.

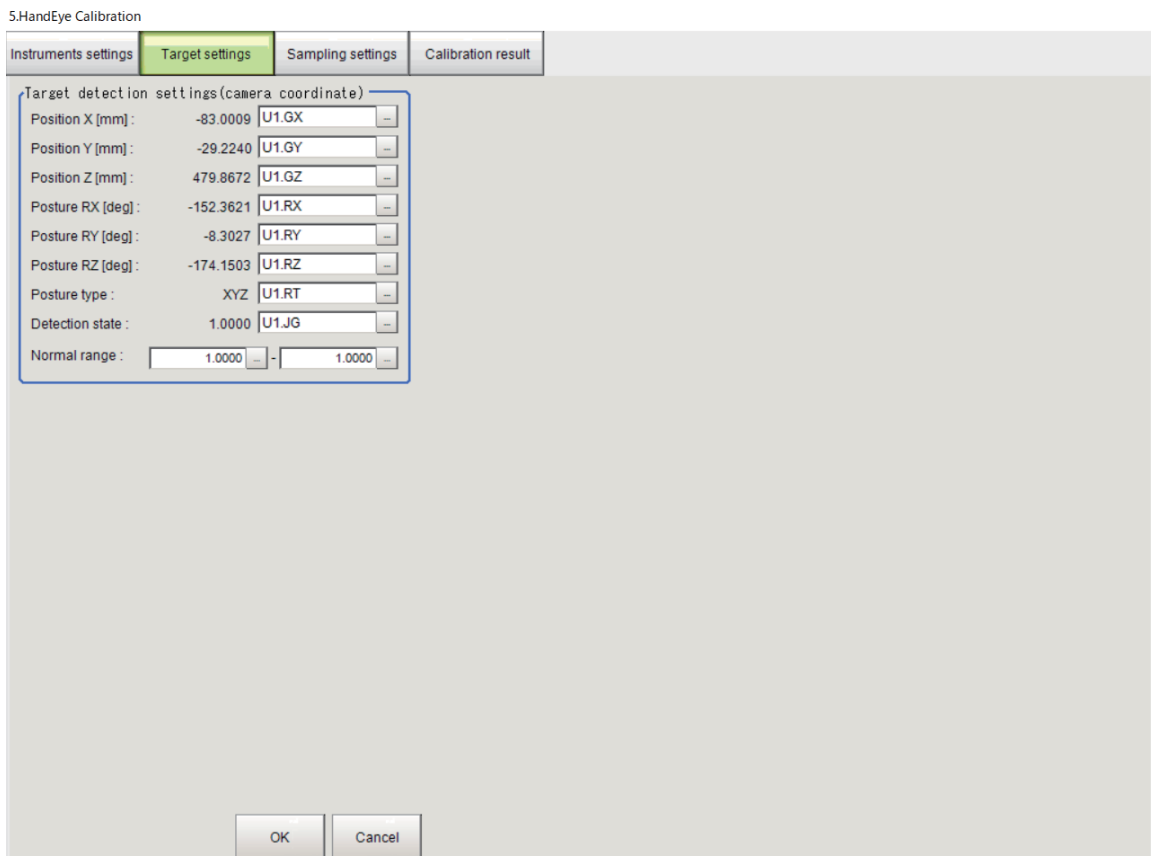

Setting item	Setting value [Factory default]	Description
Position X [mm]	-10,000.0000 to 10,000.0000[0.000 0]	Set the center of gravity position of the calibration target. Set this so that the detection results calculated in the 3D Search processing item are referenced.
Position Y [mm]	-10,000.0000 to 10,000.0000[0.000 0]	
Position Z [mm]	-10,000.0000 to 10,000.0000[0.000 0]	
Posture RX [deg] / Posture RZ [deg]	-180.0000 to 180.0000[0.0000]	Set the posture of the calibration target. Set this so that the detection results calculated in the 3D Search processing item are referenced. If you set Posture type to <i>XYZ Euler angle</i> , RX is replaced with RZ .
Posture RY [deg]	-180.0000 to 180.0000[0.0000]	
Posture RZ [deg]	-180.0000 to 180.0000[0.0000]	
Posture type	<ul style="list-style-type: none"> • 0: [ZYX] • 1: ZYZ • 2: XYZ 	Set the posture angle type of the recognized calibration target. If the calibration target is calculated in the 3D Search processing item, set this to 2 (XYZ Euler angle).
Detection state	-10,000.0000 to 10,000.0000 [0.0000]	Set the judgment result for the 3D Search processing item that references the position/posture of the calibration target.
Normal range	-10,000.0000 to 10,000.0000 [1.0000] to [1.0000]	Set the extent of the judgment conditions to which the Detection state is judged as OK.

4-4-4 Sampling settings (HandEye Calibration)

Set the data related to sampling.

The setting items differ depending on the settings of the **Robot Data** processing item.

● For on-hand cameras

The following is the setting procedure for the **Robot Data** processing item when **Camera mount** is set to *On hand camera*.

- 1 In the Item tab area, click the **Sampling settings** tab.

5.HandEye Calibration

Instruments settings | Target settings | **Sampling settings** | Calibration result

Calib. start pose(Robot base coord)

Position X [mm]: 341.3015 [SY.REVAL_CAL_S]

Position Y [mm]: -186.6195 [SY.REVAL_CAL_S]

Position Z [mm]: 470.4161 [SY.REVAL_CAL_S]

Posture RX [deg]: 161.0699 [SY.REVAL_CAL_S]

Posture RY [deg]: -1.0996 [SY.REVAL_CAL_S]

Posture RZ [deg]: -116.1751 [SY.REVAL_CAL_S]

Ref radius [mm]: 450.0000

Tool posture: Floor direction

Direction Radius(Polar coord)

Working range [mm]: 50.0000

Divisions: 2

Direction Polar(Polar coord)

Working range [deg]: 40.0000

Divisions: 4

Direction Azimuthal(Polar coord)

Working range [deg]: 40.0000

Divisions: 4

Perturbation(Sphere center coord)

Working range X [deg]: 5.0000

Working range Y [deg]: 5.0000

Working range Z [deg]: 5.0000

Robot move pose list for sampling

No.	Robot position X	Robot position Y	Robot position Z	Robot po
0.	341.3015	-186.6195	470.4161	161.0699
1.	237.1040	12.5860	444.2021	-167.1751
2.	269.0636	1.7390	444.2021	-178.0699
3.	297.6602	-16.1861	444.2021	175.1751
4.	321.3523	-40.2228	444.2021	-179.0699
5.	217.0086	-81.3067	466.9590	-172.1751
6.	227.8568	-84.9885	466.9590	175.1751
7.	237.5634	-91.0729	466.9590	175.1751
8.	245.6053	-99.2317	466.9590	-176.0699
9.	167.7599	-159.8753	466.9590	-173.1751
10.	175.8018	-168.0342	466.9590	174.0699
11.	185.5085	-174.1185	466.9590	174.0699
12.	196.3566	-177.8004	466.9590	-177.1751
13.	92.0130	-218.8842	444.2021	-170.0699
14.	115.7050	-242.9210	444.2021	174.0699
15.	144.3016	-260.8460	444.2021	171.1751
16.	176.2613	-271.6931	444.2021	177.0699
17.	172.6823	-288.4153	491.1867	176.0699
18.	136.9627	-276.2922	491.1867	170.0699
19.	105.0017	-256.2583	491.1867	175.1751
20.	78.5224	-229.3937	491.1867	-169.0699
21.	195.1418	-183.4765	516.6209	-178.1751
22.	183.0174	-179.3615	516.6209	173.0699
23.	172.1688	-172.5613	516.6209	175.1751
24.	163.1808	-163.4426	516.6209	-172.0699
25.	250.1844	-95.6644	516.6209	-177.1751
26.	241.1965	-86.5457	516.6209	174.0699
27.	230.3479	-79.7456	516.6209	176.0699
28.	128.2234	-75.6306	516.6209	-171.1751
29.	334.8428	-29.7133	491.1867	179.0699
30.	308.3635	-2.8487	491.1867	174.0699
31.	276.4025	17.1852	491.1867	179.1751

SamplingRobCoord.csv | File output

OK | Cancel

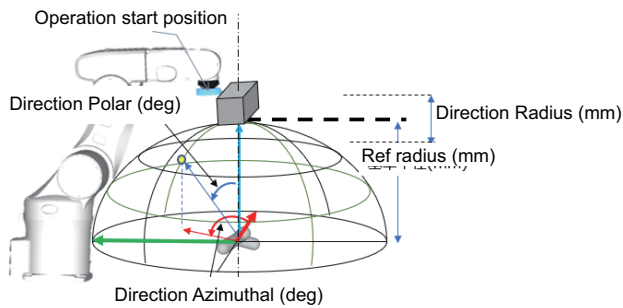

2 Set the value in the **Calib. start pose (Robot base coord)** area.

Setting item	Setting value [Factory default]	Description
Position X [mm]	-10,000.0000 to 10,000.0000 [0.0000]	Set the operation start position when acquiring data for HandEye Calibration. If you set Posture type to <i>ZYZ Euler angle</i> , RX is replaced with RZ .
Position Y [mm]	-10,000.0000 to 10,000.0000 [0.0000]	
Position Z [mm]	-10,000.0000 to 10,000.0000 [0.0000]	
Posture RX / Posture RZ [deg]	-180.0000 to 180.0000 [0.0000]	
Posture RY [deg]	-180.0000 to 180.0000 [0.0000]	
Posture RZ [deg]	-180.0000 to 180.0000 [0.0000]	
Ref radius [mm]	-10,000.0000 to 10,000.0000 [450.0000]	Set the radius of the hemisphere where sampling of data for HandEye Calibration is performed.
Tool posture	<ul style="list-style-type: none"> [Floor direction] 	Set which direction the tool points to when capturing data for HandEye Calibration. <ul style="list-style-type: none"> Floor direction: Use this setting when the calibration target is mounted on the floor (the plane in which the robot base exists).

3 Set the value in the **Direction Radius (Polar coord)** area.

Setting item	Setting value [Factory default]	Description
Working range [mm]	0.0001 to 10,000.0000 [50.0000]	Set the movement range in the radial direction of the hemisphere when capturing data. By referencing the Ref radius setting in the Calib. start pose (Robot base coord) area, the hand will move in a range of Ref radius - (Working range/ 2) for the lower limit and in a range of Ref radius + (Working range/ 2) for the upper limit.
Divisions	2 to 10 [2]	Set the number of divisions N in the radial direction of the hemisphere when capturing data. Set (N - 2) number of equally spaced sampling points (where $N \geq 2$) between the lower limit as Ref radius - (Working range/ 2) and the upper limit as Ref radius + (Working range/ 2) .

4 Set the value in the **Direction Polar (Polar coord)** area.

Setting item	Setting value [Factory default]	Description
Working range [deg]	0.0001 to 180.0000 [40.0000]	Set the movement range in the polar angle direction of the hemisphere when capturing data. If Tool posture is set to <i>Floor direction</i> in the Calib. start pose (Robot base coord) area, the hand will move in a range of 0 - (Working range/ 2) for the lower limit and in a range of 0 + (Working range/ 2) for the upper limit.

Setting item	Setting value [Factory default]	Description
Divisions	2 to 10 [4]	Set the number of divisions N in the polar angular direction of the hemisphere when capturing data. Set (N - 2) number of equally spaced sampling points (where $N \geq 2$) between the lower limit as $0 - (\text{Working range} / 2)$ and the upper limit as $0 + (\text{Working range} / 2)$. The position of the division points is adjusted to and fro if the following condition applies: The polar angle is 0 [deg], or approximately ± 90 [deg] ($-95 < \text{polar angle} < -85$ or $85 < \text{polar angle} < 95$)

5 Set the value in the **Direction Azimuthal (Polar coord)** area.

Setting item	Setting value [Factory default]	Description
Working range [deg]	0.0001 to 180.0000 [40.0000]	Set the movement range in the azimuthal direction of the hemisphere when capturing data. If Tool posture is set to <i>Floor direction</i> in the Calib. start pose (Robot base coord) area, the hand will move in a range of $0 - (\text{Working range} / 2)$ for the lower limit and in a range of $0 + (\text{Working range} / 2)$ for the upper limit.
Divisions	2 to 10 [4]	Set the number of divisions N in the azimuthal direction of the hemisphere when capturing data. Set (N - 2) number of equally spaced sampling points (where $N \geq 2$) between the lower limit as $0 - (\text{Working range} / 2)$ and the upper limit as $0 + (\text{Working range} / 2)$.

6 Set the value in the **Perturbation (Sphere center coord)** area.

Setting item	Setting value [Factory default]	Description
Working range X [deg]	0.0000 to 180.0000 [5.0000]	Panning of the camera (perturbation) is performed to capture the calibration target even outside the center of the field of view at each sampling point. At this time, set how much to pan the camera from posture in which the target is captured at the center of the field of view as the amount of rotation [deg] around each axis of the calibration target's coordinate system. If the angle is set too large, the calibration target will be out of the field of view of the camera. Therefore, you must adjust the value while actually operating the robot and checking that the calibration target exists in the captured image. In addition, if the angle is set too large, the posture of the robot hand will change significantly, which may cause a collision between the camera and the robot arm. Therefore, you must adjust the value while actually operating the robot.
Working range Y [deg]	0.0000 to 180.0000 [5.0000]	
Working range Z [deg]	0.0000 to 180.0000 [5.0000]	

7 In the **Robot move pose list for sampling** area, the sampling coordinates calculated from the parameters that you set in **Sampling settings** are listed. If it is not possible to generate robot move poses due to the parameter settings, the list is not displayed. Review the parameter settings.

The list shows the **Robot position X**, **Robot position Y**, **Robot position Z**, **Robot posture RX**, **Robot posture RY**, **Robot posture RZ**, and **Robot posture type** values.

2 Check the calibration results.

Camera coordinate seen from Flange coordinate

Item	Description
Position X [mm]	The results and error evaluation values for HandEye Calibration are displayed.
Position Y [mm]	
Position Z [mm]	Information on conversion from the flange coordinate system to the camera coordinate system is displayed.
Posture RX [deg] / Posture RZ [deg]	The smaller the error evaluation values, the more generally the calculated calibration results apply to all the sampled data. Ideally, the error evaluation values should be less than 1.0. (<i>When the error evaluation value of the calibration results is large (1.0 or more) on page 4-75</i>) If you set Posture type to <i>ZYZ Euler angle</i> , RX is replaced with RZ .
Posture RY [deg]	
Posture RZ [deg]	
Posture type	Set the posture angle type. The posture type of the robot at the completion of calibration is indicated with an asterisk (*). The calibration results for the set posture type are displayed. The calibration results are not updated. Instead, only the displayed information in the Calibration result tab is updated.
Homogeneous transformation matrix expression	The calibration results for the position/posture are displayed in homogeneous transformation matrix expression.
Enable edit / Disable edit	Click Enable edit to change the calibration result values for the position/posture. Changing the values causes the message <i>This results is modified directly</i> to appear to the right of Clear . Click Disable edit to return to the previous menu.
Clear	Click Clear to clear the calibration result values for the position/posture to 0.

Target coordinate seen from Robot base coordinate

Item	Description
Position X [mm]	The results and error evaluation values for HandEye Calibration are displayed.
Position Y [mm]	
Position Z [mm]	Information on conversion from the robot base coordinate system to the calibration target coordinate system is displayed.
Posture RX [deg] / Posture RZ [deg]	The smaller the error evaluation values, the more generally the calculated calibration results apply to all the sampled data. Ideally, the error evaluation values should be less than 1.0. (<i>When the error evaluation value of the calibration results is large (1.0 or more) on page 4-75</i>) If you set Posture type to <i>ZYZ Euler angle</i> , RX is replaced with RZ .
Posture RY [deg]	
Posture RZ [deg]	
Posture type	Set the posture angle type. The posture type of the robot at the completion of calibration is indicated with an asterisk (*). The calibration results for the set posture type are displayed. The calibration results are not updated. Instead, only the displayed information in the Calibration result tab is updated.
Homogeneous transformation matrix expression	The calibration results for the position/posture are displayed in homogeneous transformation matrix expression.
Enable edit / Disable edit	Click Enable edit to change the calibration result values for the position/posture. Changing the values causes the message <i>This results is modified directly</i> to appear to the right of Clear . Click Disable edit to return to the previous menu.

Item	Description
Clear	Click Clear to clear the calibration result values for the position/posture to 0.

- 3** In the **Sampling data list** area, the robot position/posture data and calibration target position/posture data acquired at each sampling point are displayed.
- The number of the next step that performs sampling is displayed in **Next step**:.
Click the ... button and specify a file name, and then click **File output** to save the displayed list data to the file.

4-4-6 Key Points for Test Measurement and Adjustment (HandEye Calibration)

The following content is displayed in the *Detail result* area as text.

Displayed item	Description
Judge	Judgment result 0: No judgment (unmeasured) 1: Judgment result OK -1: Judgment result NG -10: Error (image format mismatch) -12: Error (insufficient memory) -20: Error (other errors)
Step	The current step number and the total number of steps separated by a slash (/) The total number of steps and the total number of steps (completed) separated by a slash (/) are displayed at the completion of test measurement.
Error eval. (camera position X) [mm]	Error evaluation values of the calibration results These values are displayed only if test measurement is executed up to the last step.
Error eval. (camera position Y) [mm]	
Error eval. (camera position Z) [mm]	
Error eval. (camera posture RX) [deg] / Error eval. (camera posture RZ) [deg]	Error evaluation values of the calibration results These values are displayed only if test measurement is executed up to the last step. If you set Posture type to <i>ZYZ Euler angle</i> , RX is replaced with RZ .
Error eval. (camera posture RY) [deg]	
Error eval. (camera posture RZ) [deg]	
Next move position X [mm]	Robot position to which the robot moves in the next step These values are not displayed if test measurement is executed up to the last step.
Next move position Y [mm]	
Next move position Z [mm]	

Displayed item	Description
Next move posture RX [deg] / Next move posture RZ [deg]	Robot posture to which the robot moves in the next step These values are not displayed if test measurement is executed up to the last step. If you set Posture type to <i>ZYZ Euler angle</i> , RX is replaced with RZ .
Next move posture RY [deg]	
Next move posture RZ [deg]	
Posture type	Displays the settings of Robot Data processing item.

The image specified in the Sub-image number in the image display setting is displayed in the *Image Display* area.

Sub-image number	Description of image to be displayed
0	Measurement image + calibration progress status

Key Points for Adjustment (HandEye Calibration)

Adjust the setting parameters referring to the following points.

● When HandEye Calibration turns out to be NG in the middle of execution

Parameter to be adjusted	Remedy
Sampling settings	The detection of the calibration target may have failed. Review the sampling settings to ensure that the calibration target is captured by the camera at each sampling position during calibration.
Camera Image Input AOS processing item	The detection of the calibration target may have failed. Place the calibration target in the working distance of the camera or adjust the exposure time, measurement range, and other settings in the Camera Image Input AOS processing item so that the 3D point cloud can be measured to a degree that the surfaces and contours of the calibration target can be identified.
3D Search processing item	The detection of the calibration target may have failed. If the calibration target is not detected in the 3D Search processing item, adjust the settings of the 3D Search processing item.

● When HandEye Calibration turns out to be NG (calibration failure)

Parameter to be adjusted	Remedy
Target settings	The detection position/posture data for the calibration target may not be entered correctly. Review the settings to confirm that the detection results of the 3D Search processing item in the measurement flow is correctly referenced by the Target settings . The same value may always be entered in the detection position/posture data for the calibration target. Review the settings to see if, for example, the settings in the Target settings tab have fixed values to ensure that the robot moves to different sampling positions to capture images (i.e., perform 3D search on different images).

- **When the robot stops during HandEye Calibration**

Parameter to be adjusted	Remedy
Sampling settings	The sampling point may contain coordinates in which the robot cannot operate. Review the sampling settings to ensure that the coordinates are set so that the robot can operate.

- **When the robot does not operate after HandEye Calibration**

Parameter to be adjusted	Remedy
- (Robot operation settings)	The robot may not be in a standby state. Set the robot so that it can communicate with external devices.
-	When the calibration is completed, the robot does not operate even if the HandEye calibration is performed.

- **When the robot does not move to the intended position**

Parameter to be adjusted	Remedy
Robot Data processing item Target settings	The posture type of the robot set in the Robot Data processing item may differ from the posture type of the robot in the Target settings . Make sure that the posture type set in the Target settings matches the posture type set in the Robot Data processing item.
Sampling settings	The values of the expressions set in Calib. start pose in the Sampling settings tab may have changed from the values set during measurement. In the Calibration result tab, check that the robot position for the sampling data shown at the top of the Sampling data list shows the intended coordinates. In the Sampling settings tab, set the intended operation start position of the robot as a reference in the expression strings in advance.

- **When the error evaluation value of the calibration results is large (1.0 or more)**

Parameter to be adjusted	Remedy
Sampling settings	Valid data may not be sampled because the sampling range is too narrow. Check that the sampling range is not too narrow.
	Valid data may not be sampled because the sampling range is too narrow. Check the sampled data to see if the amount of change in the posture of the calibration target is not too small and set the perturbation.
	Valid data may not be sampled because the sampling range is too narrow. For on-hand cameras, increase the value of Divisions in the radial direction.
3D Search processing item	The detected calibration target may be out of position. Check if the detected calibration target is not out of position in the 3D Search processing item, and adjust the setting.
- (Robot operation settings)	The robot may not be able to move to the specified sampling point. Perform calibration at a slower robot speed so that image capture does not start before the robot stops and stands still.

● When the same settings produce different calibration results

Parameter to be adjusted	Remedy
-	The same settings do not always produce the same values at each capture due to variations in the amount of exposure, etc. If the calibration results vary significantly, eliminate the factors of variation in the surrounding environment such as the effect of external lighting.

● Other cases

Parameter to be adjusted	Remedy
Calibration result	To redo the calibration from the beginning, in the Calibration result tab, click Clear in the Sampling data list area or clear the measurement results.
Instruments settings	<p>If you cannot select the Unit ref number because it is set to <None>, check if the selected Scene ref number is correct. Check that the Robot Data processing item is registered in the selected reference scene.</p> <p>The reference unit number does not change during flow editing, which is the specifications.</p> <p>While a scene other than the current scene is referenced, the reference unit number does not change according to the editing of the flow. Change the flow so that the current scene will be referenced, or set the reference unit number again.</p>

4-4-7 Measurement Results for Which Output Is Possible (HandEye Calibration)

The following values can be output using processing items related to result output. It is also possible to reference measurement values from calculation expressions and other processing units.

Measurement items	Character string	Description
Judge	JG	Judgment result 0: No judgment (unmeasured) 1: Judgment result OK -1: Judgment result NG -10: Error (image format mismatch) -12: Error (insufficient memory) -20: Error (other errors)
Step	CT	Step number
End flag	ENDF	0: No completed, 1: Completed
Next move position X	NMX	Robot position to which the robot moves in the next step
Next move position Y	NMY	
Next move position Z	NMZ	
Next move posture RA	NMRA	Robot posture to which the robot moves in the next step
Next move posture RY	NMRB	
Next move posture RZ	NMRC	
Camera position X	CTX	Camera position X
Camera position Y	CTY	Camera position Y
Camera position Z	CTZ	Camera position Z
Camera posture RA	CRA	Camera posture RA
Camera posture RY	CRB	Camera posture RY

Measurement items	Character string	Description
Camera posture RZ	CRC	Camera posture RZ
Camera posture type	CRT	Camera posture type
Error eval. (camera position X)	ECTX	Error eval. (camera position X)
Error eval. (camera position Y)	ECTY	Error eval. (camera position Y)
Error eval. (camera position Z)	ECTZ	Error eval. (camera position Z)
Error eval. (camera posture RA)	ECRA	Error eval. (camera posture RA)
Error eval. (camera posture RY)	ECRB	Error eval. (camera posture RY)
Error eval. (camera posture RZ)	ECRC	Error eval. (camera posture RZ)
Target position X	TTX	Target position X
Target position Y	TTY	Target position Y
Target position Z	TTZ	Target position Z
Target posture RA	TRA	Target posture RA
Target posture RY	TRB	Target posture RY
Target posture RZ	TRC	Target posture RZ
Target posture type	TRT	Target posture type
Error eval. (target position X)	ETTX	Error eval. (target position X)
Error eval. (target position Y)	ETTY	Error eval. (target position Y)
Error eval. (target position Z)	ETTZ	Error eval. (target position Z)
Error eval. (target posture RA)	ETRA	Error eval. (target posture RA)
Error eval. (target posture RY)	ETRB	Error eval. (target posture RY)
Error eval. (target posture RZ)	ETRC	Error eval. (target posture RZ)

4-4-8 External Reference Tables (HandEye Calibration)

No.	Data name	Data ident	Set/Get	Data range
0	Judge	judge	Get only	0: No judgment (unmeasured), 1: Judgment result OK, -1: Judgment result NG, -10: Error (image format mismatch), -11: Error (unregistered model), -12: Error (insufficient memory), -20: Error (other errors)
6	Step	calibStepCounter	Get only	-2,147,483,647 to 2,147,483,647
7	End flag	calibEndFlg	Get only	0: -, 1: End
8	Next move position X	nextRobotMoveTX	Get only	-10,000.0000 to 10,000.0000 [mm]
9	Next move position Y	nextRobotMoveTY	Get only	-10,000.0000 to 10,000.0000 [mm]
10	Next move position Z	nextRobotMoveTZ	Get only	-10,000.0000 to 10,000.0000 [mm]
11	Next move posture RA	nextRobotMoveRA	Get only	-180.0000 to 180.0000 [deg]
12	Next move posture RY	nextRobotMoveRB	Get only	-180.0000 to 180.0000 [deg]
13	Next move posture RZ	nextRobotMoveRC	Get only	-180.0000 to 180.0000 [deg]

No.	Data name	Data ident	Set/Get	Data range
14	Calib. start position X	valStartingRobotPoseTX	Get only	-10,000.0000 to 10,000.0000 [mm] Robot base coordinate
15	Calib. start position Y	valStartingRobotPoseTY	Get only	-10,000.0000 to 10,000.0000 [mm] Robot base coordinate
16	Calib. start position Z	valStartingRobotPoseTZ	Get only	-10,000.0000 to 10,000.0000 [mm] Robot base coordinate
17	Calib. start posture RA	valStartingRobotPoseRA	Get only	-180.0000 to 180.0000 [deg] Robot base coordinate
18	Calib. start posture RY	valStartingRobotPoseRB	Get only	-180.0000 to 180.0000 [deg] Robot base coordinate
19	Calib. start posture RZ	valStartingRobotPoseRC	Get only	-180.0000 to 180.0000 [deg] Robot base coordinate
20	Target detection position X	valSamplingTargetPoseTX	Get only	-10,000.0000 to 10,000.0000 [mm] Camera coordinate
21	Target detection position Y	valSamplingTargetPoseTY	Get only	-10,000.0000 to 10,000.0000 [mm] Camera coordinate
22	Target detection position Z	valSamplingTargetPoseTZ	Get only	-10,000.0000 to 10,000.0000 [mm] Camera coordinate
23	Target detection posture RA	valSamplingTargetPoseRA	Get only	-180.0000 to 180.0000 [deg] Camera coordinate
24	Target detection posture RY	valSamplingTargetPoseRB	Get only	-180.0000 to 180.0000 [deg] Camera coordinate
25	Target detection posture RZ	valSamplingTargetPoseRC	Get only	-180.0000 to 180.0000 [deg] Camera coordinate
26	Target detection posture type	valSamplingTargetRotType	Get only	0: ZYX Euler angle, 1: ZYZ Euler angle, 2: XYZ Euler angle
27	Target detection state	valSamplingJudge	Get only	-10,000.0000 to 10,000.0000
101	Scene No. of robot data unit	robotSceneNo	Set/Get	-1 to 1,023
102	Unit No. of robot data unit	robotUnitNo	Set/Get	-1 to 9,999
105	Camera mount kind	onhandCamPosKind	Set/Get	0: X-axis plus direction, 1: X-axis minus direction, 2: Y-axis plus direction, 3: Y-axis minus direction, 4: Custom
106	Camera mount position X	onhandCamPosX	Set/Get	-10,000.0000 to 10,000.0000 [mm] Flange coordinate
107	Camera mount position Y	onhandCamPosY	Set/Get	-10,000.0000 to 10,000.0000 [mm] Flange coordinate
108	Camera mount position Z	onhandCamPosZ	Set/Get	-10,000.0000 to 10,000.0000 [mm] Flange coordinate
109	Camera mount posture RA	onhandCamPosRA	Set/Get	-180.0000 to 180.0000 [deg] Flange coordinate
110	Camera mount posture RY	onhandCamPosRB	Set/Get	-180.0000 to 180.0000 [deg] Flange coordinate
111	Camera mount posture RZ	onhandCamPosRC	Set/Get	-180.0000 to 180.0000 [deg] Flange coordinate

No.	Data name	Data ident	Set/Get	Data range
112	Camera mount posture type	onhandCamPosRT	Set/Get	0: ZYX Euler angle, 1: ZYZ Euler angle, 2: XYZ Euler angle
113	Target detection position X (expr. value)	expSamplingTargetPoseTX	Set/Get	-10,000.0000 to 10,000.0000 [mm] Camera coordinate
114	Target detection position Y (expr. value)	expSamplingTargetPoseTY	Set/Get	-10,000.0000 to 10,000.0000 [mm] Camera coordinate
115	Target detection position Z (expr. value)	expSamplingTargetPoseTZ	Set/Get	-10,000.0000 to 10,000.0000 [mm] Camera coordinate
116	Target detection posture RA (expr. value)	expSamplingTargetPoseRA	Set/Get	-180.0000 to 180.0000 [deg] Camera coordinate
117	Target detection posture RY (expr. value)	expSamplingTargetPoseRB	Set/Get	-180.0000 to 180.0000 [deg] Camera coordinate
118	Target detection posture RZ (expr. value)	expSamplingTargetPoseRC	Set/Get	-180.0000 to 180.0000 [deg] Camera coordinate
119	Target detection posture type (expr. value)	expSamplingTargetRotType	Set/Get	0: ZYX Euler angle, 1: ZYZ Euler angle, 2: XYZ Euler angle
120	Target detection state (expr. value)	expSamplingJudge	Set/Get	-10,000.0000 to 10,000.0000
121	Upper limit of target normal detection	uppSamplingJudge	Set/Get	-10,000.0000 to 10,000.0000
122	Lower limit of target normal detection	lowSamplingJudge	Set/Get	-10,000.0000 to 10,000.0000
126	Calib. start position X (expr. value)	expStartingRobotPoseTX	Set/Get	-10,000.0000 to 10,000.0000 [mm] Robot base coordinate
127	Calib. start position Y (expr. value)	expStartingRobotPoseTY	Set/Get	-10,000.0000 to 10,000.0000 [mm] Robot base coordinate
128	Calib. start position Z (expr. value)	expStartingRobotPoseTZ	Set/Get	-10,000.0000 to 10,000.0000 [mm] Robot base coordinate
129	Calib. start posture RA (expr. value)	expStartingRobotPoseRA	Set/Get	-180.0000 to 180.0000 [deg] Robot base coordinate
130	Calib. start posture RY (expr. value)	expStartingRobotPoseRB	Set/Get	-180.0000 to 180.0000 [deg] Robot base coordinate
131	Calib. start posture RZ (expr. value)	expStartingRobotPoseRC	Set/Get	-180.0000 to 180.0000 [deg] Robot base coordinate
132	Perturbation range X	samplingPerturbAngleX	Set/Get	0.0000 to 180.0000 [deg]
133	Perturbation range Y	samplingPerturbAngleY	Set/Get	0.0000 to 180.0000 [deg]
134	Perturbation range Z	samplingPerturbAngleZ	Set/Get	0.0000 to 180.0000 [deg]
146	Ref radius	samplingRobotMoveRefRadius	Set/Get	-10,000.0000 to 10,000.0000 [mm]
149	Working range on radius direction	samplingRobotMoveRangeRadius	Set/Get	0.0001 to 10,000.0000 [mm]
150	Working range on polar direction	samplingRobotMoveRangeTheta	Set/Get	0.0001 to 180.0000 [deg]
151	Working range on azimuthal direction	samplingRobotMoveRangePhi	Set/Get	0.0001 to 180.0000 [deg]

No.	Data name	Data ident	Set/Get	Data range
152	Division range on radius direction	samplingDivision-NumRadius	Set/Get	2 to 10
153	Division range on polar direction	samplingDivision-NumTheta	Set/Get	2 to 10
154	Division range on azimuthal direction	samplingDivision-NumPhi	Set/Get	2 to 10
156	Camera position X (calib. result)	resultTransCamTX	Set/Get	-10,000.0000 to 10,000.0000 [mm]
157	Camera position Y (calib. result)	resultTransCamTY	Set/Get	-10,000.0000 to 10,000.0000 [mm]
158	Camera position Z (calib. result)	resultTransCamTZ	Set/Get	-10,000.0000 to 10,000.0000 [mm]
159	Camera posture RA (calib. result)	resultAngleCamRA	Set/Get	-180.0000 to 180.0000 [deg]
160	Camera posture RY (calib. result)	resultAngleCamRB	Set/Get	-180.0000 to 180.0000 [deg]
161	Camera posture RZ (calib. result)	resultAngleCamRC	Set/Get	-180.0000 to 180.0000 [deg]
162	Rot matrix 11 (camera posture)	resultRotMatCam11	Get only	-1.0000 to 1.0000
163	Rot matrix 12 (camera posture)	resultRotMatCam12	Get only	-1.0000 to 1.0000
164	Rot matrix 13 (camera posture)	resultRotMatCam13	Get only	-1.0000 to 1.0000
165	Rot matrix 21 (camera posture)	resultRotMatCam21	Get only	-1.0000 to 1.0000
166	Rot matrix 22 (camera posture)	resultRotMatCam22	Get only	-1.0000 to 1.0000
167	Rot matrix 23 (camera posture)	resultRotMatCam23	Get only	-1.0000 to 1.0000
168	Rot matrix 31 (camera posture)	resultRotMatCam31	Get only	-1.0000 to 1.0000
169	Rot matrix 32 (camera posture)	resultRotMatCam32	Get only	-1.0000 to 1.0000
170	Rot matrix 33 (camera posture)	resultRotMatCam33	Get only	-1.0000 to 1.0000
171	Target position X (calib. result)	resultTransTargTX	Set/Get	-10,000.0000 to 10,000.0000 [mm]
172	Target position Y (calib. result)	resultTransTargTY	Set/Get	-10,000.0000 to 10,000.0000 [mm]
173	Target position Z (calib. result)	resultTransTargTZ	Set/Get	-10,000.0000 to 10,000.0000 [mm]
174	Target posture RA (calib. result)	resultAngleTargRA	Set/Get	-180.0000 to 180.0000 [deg]
175	Target posture RY (calib. result)	resultAngleTargRB	Set/Get	-180.0000 to 180.0000 [deg]
176	Target posture RZ (calib. result)	resultAngleTargRC	Set/Get	-180.0000 to 180.0000 [deg]
177	Rot matrix 11 (target posture)	resultRotMatTarg11	Get only	-1.0000 to 1.0000

No.	Data name	Data ident	Set/Get	Data range
178	Rot matrix 12 (target posture)	resultRotMatTarg12	Get only	-1.0000 to 1.0000
179	Rot matrix 13 (target posture)	resultRotMatTarg13	Get only	-1.0000 to 1.0000
180	Rot matrix 21 (target posture)	resultRotMatTarg21	Get only	-1.0000 to 1.0000
181	Rot matrix 22 (target posture)	resultRotMatTarg22	Get only	-1.0000 to 1.0000
182	Rot matrix 23 (target posture)	resultRotMatTarg23	Get only	-1.0000 to 1.0000
183	Rot matrix 31 (target posture)	resultRotMatTarg31	Get only	-1.0000 to 1.0000
184	Rot matrix 32 (target posture)	resultRotMatTarg32	Get only	-1.0000 to 1.0000
185	Rot matrix 33 (target posture)	resultRotMatTarg33	Get only	-1.0000 to 1.0000
186	Camera posture type	evalPostureType-Cam	Set/Get	0: ZYX Euler angle, 1: ZYZ Euler angle, 2: XYZ Euler angle
187	Target posture type	evalPostureTypeTrgt	Set/Get	0: ZYX Euler angle, 1: ZYZ Euler angle, 2: XYZ Euler angle
1000	Robot type	machineType	Get only	-1: Unspecified, 0: 3-axis(XYZ) robot, 1: 4-axis(XYZR) robot, 2: 6-axis(XYZWPR) robot
1001	Robot posture type	poseRotationType	Get only	-1: Unspecified, 0: ZYX Euler angle, 1: ZYZ Euler angle, 2: XYZ Euler angle
1002	Camera mount	cameraMount	Get only	-1: Unspecified, 0: Fixed camera, 1: On hand camera
1003	Sampling number	samplingNum	Get only	0 to 2,147,483,647
1005	Error eval. (camera position X)	resultErrorTransCamTX	Get only	-10,000.0000 to 10,000.0000 [mm]
1006	Error eval. (camera position Y)	resultErrorTransCamTY	Get only	-10,000.0000 to 10,000.0000 [mm]
1007	Error eval. (camera position Z)	resultErrorTransCamTZ	Get only	-10,000.0000 to 10,000.0000 [mm]
1008	Error eval. (camera posture RA)	resultErrorAngle-CamRA	Get only	-180.0000 to 180.0000 [deg]
1009	Error eval. (camera posture RY)	resultErrorAngle-CamRB	Get only	-180.0000 to 180.0000 [deg]
1010	Error eval. (camera posture RZ)	resultErrorAngle-CamRC	Get only	-180.0000 to 180.0000 [deg]
1011	Error eval. (target position X)	resultErrorTransTargTX	Get only	-10,000.0000 to 10,000.0000 [mm]
1012	Error eval. (target position Y)	resultErrorTransTargTY	Get only	-10,000.0000 to 10,000.0000 [mm]
1013	Error eval. (target position Z)	resultErrorTransTargTZ	Get only	-10,000.0000 to 10,000.0000 [mm]

No.	Data name	Data ident	Set/Get	Data range
1014	Error eval. (target posture RA)	resultErrorAngleTargRA	Get only	-180.0000 to 180.0000 [deg]
1015	Error eval. (target posture RY)	resultErrorAngleTargRB	Get only	-180.0000 to 180.0000 [deg]
1016	Error eval. (target posture RZ)	resultErrorAngleTargRC	Get only	-180.0000 to 180.0000 [deg]
1017	Robot type (calib. result)	resultMachineType	Get only	-1: Unspecified, 0: 3-axis(XYZ) robot, 1: 4-axis(XYZR) robot, 2: 6-axis(XYZWPR) robot
1018	Camera mount on robot tool (calib. result)	resultCamMountType	Get only	-1: Unspecified, 0: Fixed camera, 1: On hand camera
1019	Posture type (calib. result)	resultPoseRotType	Get only	-1: Unspecified, 0: ZYX Euler angle, 1: ZYZ Euler angle, 2: XYZ Euler angle
1020	Camera posture RA (calib. result)	resultAngleCamRAEval	Get only	-180.0000 to 180.0000 [deg] For confirming
1021	Camera posture RY (calib. result)	resultAngleCamRBEval	Get only	-180.0000 to 180.0000 [deg] For confirming
1022	Camera posture RZ (calib. result)	resultAngleCamRCEval	Get only	-180.0000 to 180.0000 [deg] For confirming
1023	Error eval. (camera posture RA)	resultErrorAngleCamRAEval	Get only	-180.0000 to 180.0000 [deg] For confirming
1024	Error eval. (camera posture RY)	resultErrorAngleCamRBEval	Get only	-180.0000 to 180.0000 [deg] For confirming
1025	Error eval. (camera posture RZ)	resultErrorAngleCamRCEval	Get only	-180.0000 to 180.0000 [deg] For confirming
1026	Target posture RA (calib. result)	resultAngleTargRAEval	Get only	-180.0000 to 180.0000 [deg] For confirming
1027	Target posture RY (calib. result)	resultAngleTargRBEval	Get only	-180.0000 to 180.0000 [deg] For confirming
1028	Target posture RZ (calib. result)	resultAngleTargRCEval	Get only	-180.0000 to 180.0000 [deg] For confirming
1029	Error eval. (target posture RA)	resultErrorAngleTargRAEval	Get only	-180.0000 to 180.0000 [deg] For confirming
1030	Error eval. (target posture RY)	resultErrorAngleTargRBEval	Get only	-180.0000 to 180.0000 [deg] For confirming
1031	Error eval. (target posture RZ)	resultErrorAngleTargRCEval	Get only	-180.0000 to 180.0000 [deg] For confirming
100000+N (N=0 to 1499)	Robot position X 0 : Robot position X 1499	samplingRobotPoseTX0 : samplingRobotPoseTX1499	Get only	-10,000.0000 to 10,000.0000 [mm] Robot base coordinate
102000+N (N=0 to 1499)	Robot position Y 0 : Robot position Y 1499	samplingRobotPoseTY0 : samplingRobotPoseTY1499	Get only	-10,000.0000 to 10,000.0000 [mm] Robot base coordinate

No.	Data name	Data ident	Set/Get	Data range
104000+N (N=0 to 1499)	Robot position Z 0 : Robot position Z 1499	samplingRobotPoseTZ0 : samplingRobotPoseTZ1499	Get only	-10,000.0000 to 10,000.0000 [mm] Robot base coordinate
106000+N (N=0 to 1499)	Robot posture RA 0 : Robot posture RA 1499	samplingRobotPoseRA0 : samplingRobotPoseRA1499	Get only	-180.0000 to 180.0000 [deg] Robot base coordinate
108000+N (N=0 to 1499)	Robot posture RY 0 : Robot posture RY 1499	samplingRobotPoseRB0 : samplingRobotPoseRB1499	Get only	-180.0000 to 180.0000 [deg] Robot base coordinate
110000+N (N=0 to 1499)	Robot posture RZ 0 : Robot posture RZ 1499	samplingRobotPoseRC0 : samplingRobotPoseRC1499	Get only	-180.0000 to 180.0000 [deg] Robot base coordinate
112000+N (N=0 to 1499)	Target position X 0 : Target position X 1499	samplingTargetPoseTX0 : samplingTargetPoseTX1499	Get only	-10,000.0000 to 10,000.0000 [mm] Camera coordinate
114000+N (N=0 to 1499)	Target position Y 0 : Target position Y 1499	samplingTargetPoseTY0 : samplingTargetPoseTY1499	Get only	-10,000.0000 to 10,000.0000 [mm] Camera coordinate
116000+N (N=0 to 1499)	Target position Z 0 : Target position Z 1499	samplingTargetPoseTZ0 : samplingTargetPoseTZ1499	Get only	-10,000.0000 to 10,000.0000 [mm] Camera coordinate
118000+N (N=0 to 1499)	Target posture RA 0 : Target posture RA 1499	samplingTargetPoseRA0 : samplingTargetPoseRA1499	Get only	-180.0000 to 180.0000 [deg] Camera coordinate
120000+N (N=0 to 1499)	Target posture RY 0 : Target posture RY 1499	samplingTargetPoseRB0 : samplingTargetPoseRB1499	Get only	-180.0000 to 180.0000 [deg] Camera coordinate
122000+N (N=0 to 1499)	Target posture RZ 0 : Target posture RZ 1499	samplingTargetPoseRC0 : samplingTargetPoseRC1499	Get only	-180.0000 to 180.0000 [deg] Camera coordinate



Branch

This chapter describes setting methods for when branch processing is performed.

5-1	FH series 3D robot vision system Processing items	5-2
5-1-1	Branch	5-2

5-1 FH series 3D robot vision system Processing items

In FH series 3D robot vision system, the processing items that can be used with the FH series are different. The following shows the usability of processing items of FH series 3D robot vision system. Refer to the *Vision System FH/FHV Series Processing Item Function Reference Manual (Cat. No. Z341)*, for information on each processing item other than the FH series 3D robot vision system processing items.



Precautions for Correct Use

FH series 3D robot vision system cannot load data including processing items which it cannot be handled.

5-1-1 Branch

Processing item	Support	Processing item	Support
Conditional Branch	-	Selective Branch	-
End	OK	Conditional execution (If)	OK
DI Branch	-	Conditional execution (Else)	OK
Control Flow Normal	-	Loop	OK
Control Flow PLC Link	-	Loop suspension	OK
Control Flow Parallel	-	Select execution (Select)	OK
Control Flow Fieldbus	-	Select execution (Case)	OK



Output Result

This chapter describes setting methods when measurement results are output to the external devices.

6-1	FH series 3D robot vision system Processing items	6-2
6-1-1	Output result	6-2

6-1 FH series 3D robot vision system Processing items

In FH series 3D robot vision system, the processing items that can be used with the FH series are different. The following shows the usability of processing items of FH series 3D robot vision system. Refer to the *Vision System FH/FHV Series Processing Item Function Reference Manual (Cat. No. Z341)*, for information on each processing item other than the FH series 3D robot vision system processing items.



Precautions for Correct Use

FH series 3D robot vision system cannot load data including processing items which it cannot be handled.

6-1-1 Output result

Processing item	Support	Processing item	Support
Result output (I/O)	OK	Parallel Data Output	-
Result output (Message)	OK	Parallel Judgement Output	-
Data Output	OK	Fieldbus Data Output	-
Result output (Parallel I / O)	-		



Display Result

This chapter describes how to display strings and figures in the window that displays the measurement results.

7-1	FH series 3D robot vision system Processing items	7-2
7-1-1	Display result	7-2

7-1 FH series 3D robot vision system Processing items

In FH series 3D robot vision system, the processing items that can be used with the FH series are different. The following shows the usability of processing items of FH series 3D robot vision system. Refer to the *Vision System FH/FHV Series Processing Item Function Reference Manual (Cat. No. Z341)*, for information on each processing item other than the FH series 3D robot vision system processing items.



Precautions for Correct Use

FH series 3D robot vision system cannot load data including processing items which it cannot be handled.

7-1-1 Display result

Processing item	Support	Processing item	Support
Result Display	OK	Conveyor Panorama Display	-
Display Image File	-	Display image hold	OK
Display Last NG Image	OK		



Index



Index

Numerics

3D Data Manager	4-3
3D Search.....	2-4

C

Camera Calibration AOS.....	4-40
Camera Image Input AOS.....	1-3
Checking 3D Measurement Results..	1-13, 2-28, 2-60, 2-102
Container Detection.....	2-44

F

FH series 3D robot vision system Processing items.....	1-2, 2-3, 3-2, 4-2, 5-2, 6-2, 7-2
FZ-3DVisualizer.....	1-13, 2-28, 2-60, 2-102

G

Grasp Planning.....	2-83
GraspTeachGUI.....	4-22

H

HandEye Calibration.....	4-61
HandMaker.....	4-6

T

Terms and Conditions.....	9
---------------------------	---

OMRON Corporation Industrial Automation Company

Kyoto, JAPAN

Contact : www.ia.omron.com

Regional Headquarters

OMRON EUROPE B.V.

Wegalaan 67-69, 2132 JD Hoofddorp
The Netherlands
Tel: (31) 2356-81-300 Fax: (31) 2356-81-388

OMRON ELECTRONICS LLC

2895 Greenspoint Parkway, Suite 200
Hoffman Estates, IL 60169 U.S.A.
Tel: (1) 847-843-7900 Fax: (1) 847-843-7787

OMRON ASIA PACIFIC PTE. LTD.

438B Alexandra Road, #08-01/02 Alexandra
Technopark, Singapore 119968
Tel: (65) 6835-3011 Fax: (65) 6835-3011

OMRON (CHINA) CO., LTD.

Room 2211, Bank of China Tower,
200 Yin Cheng Zhong Road,
PuDong New Area, Shanghai, 200120, China
Tel: (86) 21-6023-0333 Fax: (86) 21-5037-2388

Authorized Distributor:

©OMRON Corporation 2021-2024 All Rights Reserved.
In the interest of product improvement,
specifications are subject to change without notice.

Cat. No. Z445-E1-03 0624